

STATE OF NORTH CAROLINA  
DEPARTMENT OF TRANSPORTATION  
RALEIGH, N.C.

C203663

CONTRACT AND  
CONTRACT BONDS

FOR CONTRACT NO. C203663

WBS 42845.3.FD1 BRSTP-1008(23)

T.I.P NO. B-5243

COUNTY OF UNION

THIS IS THE ROADWAY & STRUCTURE CONTRACT

ROUTE NUMBER SR 1008 LENGTH 0.187 MILES

LOCATION BRIDGE OVER S FORK CROOKED CREEK ON SR-1008 (INDIAN TRAIL RD SOUTH) & IMPROVEMENT OF THE INT OF SR-1009 & SR-1371.

CONTRACTOR SEALAND CONTRACTORS CORP

ADDRESS 1708 N CALDWELL ST  
CHARLOTTE, NC 28206

BIDS OPENED JANUARY 19, 2016

CONTRACT EXECUTION 2/10/2016

STATE OF NORTH CAROLINA  
DEPARTMENT OF TRANSPORTATION  
RALEIGH, N.C.

PROPOSAL

**INCLUDES ADDENDUM No. 1 DATED 01-08-16**

DATE AND TIME OF BID OPENING: **JANUARY 19, 2016 AT 2:00 PM**

CONTRACT ID C203663  
WBS 42845.3.FD1

FEDERAL-AID NO. BRSTP-1008(23)  
COUNTY UNION  
T.I.P. NO. B-5243  
MILES 0.187  
ROUTE NO. SR 1008  
LOCATION BRIDGE OVER S FORK CROOKED CREEK ON SR-1008 (INDIAN TRAIL RD SOUTH) & IMPROVEMENT OF THE INT OF SR-1009 & SR-1371.

TYPE OF WORK GRADING, DRAINAGE, PAVING, SIGNALS, AND CULVERT.

**NOTICE:**

ALL BIDDERS SHALL COMPLY WITH ALL APPLICABLE LAWS REGULATING THE PRACTICE OF GENERAL CONTRACTING AS CONTAINED IN CHAPTER 87 OF THE GENERAL STATUTES OF NORTH CAROLINA WHICH REQUIRES THE BIDDER TO BE LICENSED BY THE N.C. LICENSING BOARD FOR CONTRACTORS WHEN BIDDING ON ANY NON-FEDERAL AID PROJECT WHERE THE BID IS \$30,000 OR MORE, EXCEPT FOR CERTAIN SPECIALTY WORK AS DETERMINED BY THE LICENSING BOARD. BIDDERS SHALL ALSO COMPLY WITH ALL OTHER APPLICABLE LAWS REGULATING THE PRACTICES OF ELECTRICAL, PLUMBING, HEATING AND AIR CONDITIONING AND REFRIGERATION CONTRACTING AS CONTAINED IN CHAPTER 87 OF THE GENERAL STATUTES OF NORTH CAROLINA. NOTWITHSTANDING THESE LIMITATIONS ON BIDDING, THE BIDDER WHO IS AWARDED ANY FEDERAL - AID FUNDED PROJECT SHALL COMPLY WITH CHAPTER 87 OF THE GENERAL STATUTES OF NORTH CAROLINA FOR LICENSING REQUIREMENTS WITHIN 60 CALENDAR DAYS OF BID OPENING.

**BIDS WILL BE RECEIVED AS SHOWN BELOW:**

**THIS IS A ROADWAY & STRUCTURE PROPOSAL**

**5% BID BOND OR BID DEPOSIT REQUIRED**

---

**PROPOSAL FOR THE CONSTRUCTION OF  
CONTRACT No. C203663 IN UNION COUNTY, NORTH CAROLINA**

Date \_\_\_\_\_ 20 \_\_\_\_\_

**DEPARTMENT OF TRANSPORTATION,  
RALEIGH, NORTH CAROLINA**

The Bidder has carefully examined the location of the proposed work to be known as Contract No. C203663; has carefully examined the plans and specifications, which are acknowledged to be part of the proposal, the special provisions, the proposal, the form of contract, and the forms of contract payment bond and contract performance bond; and thoroughly understands the stipulations, requirements and provisions. The undersigned bidder agrees to be bound upon his execution of the bid and subsequent award to him by the Board of Transportation in accordance with this proposal to provide the necessary contract payment bond and contract performance bond within fourteen days after the written notice of award is received by him. The undersigned Bidder further agrees to provide all necessary machinery, tools, labor, and other means of construction; and to do all the work and to furnish all materials, except as otherwise noted, necessary to perform and complete the said contract in accordance with *the 2012 Standard Specifications for Roads and Structures* by the dates(s) specified in the Project Special Provisions and in accordance with the requirements of the Engineer, and at the unit or lump sum prices, as the case may be, for the various items given on the sheets contained herein.

The Bidder shall provide and furnish all the materials, machinery, implements, appliances and tools, and perform the work and required labor to construct and complete State Highway Contract No. C203663 in Union County, for the unit or lump sum prices, as the case may be, bid by the Bidder in his bid and according to the proposal, plans, and specifications prepared by said Department, which proposal, plans, and specifications show the details covering this project, and hereby become a part of this contract.

The published volume entitled *North Carolina Department of Transportation, Raleigh, Standard Specifications for Roads and Structures, January 2012* with all amendments and supplements thereto, is by reference incorporated into and made a part of this contract; that, except as herein modified, all the construction and work included in this contract is to be done in accordance with the specifications contained in said volume, and amendments and supplements thereto, under the direction of the Engineer.

If the proposal is accepted and the award is made, the contract is valid only when signed either by the Contract Officer or such other person as may be designated by the Secretary to sign for the Department of Transportation. The conditions and provisions herein cannot be changed except over the signature of the said Contract Officer.

The quantities shown in the itemized proposal for the project are considered to be approximate only and are given as the basis for comparison of bids. The Department of Transportation may increase or decrease the quantity of any item or portion of the work as may be deemed necessary or expedient.

An increase or decrease in the quantity of an item will not be regarded as sufficient ground for an increase or decrease in the unit prices, nor in the time allowed for the completion of the work, except as provided for the contract.

Accompanying this bid is a bid bond secured by a corporate surety, or certified check payable to the order of the Department of Transportation, for five percent of the total bid price, which deposit is to be forfeited as liquidated damages in case this bid is accepted and the Bidder shall fail to provide the required payment and performance bonds with the Department of Transportation, under the condition of this proposal, within 14 calendar days after the written notice of award is received by him, as provided in the *Standard Specifications*; otherwise said deposit will be returned to the Bidder.

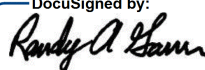

State Contract Officer

DocuSigned by:  
  
A7079FC32A09478...

1/8/2016

**TABLE OF CONTENTS**

**COVER SHEET  
PROPOSAL SHEET**

**PROJECT SPECIAL PROVISIONS**

CONTRACT TIME AND LIQUIDATED DAMAGES: ..... G-1  
INTERMEDIATE CONTRACT TIME NUMBER 1 AND LIQUIDATED DAMAGES: ..... G-1  
INTERMEDIATE CONTRACT TIME NUMBER 2 AND LIQUIDATED DAMAGES: ..... G-2  
INTERMEDIATE CONTRACT TIME NUMBER 3 AND LIQUIDATED DAMAGES: ..... G-3  
PERMANENT VEGETATION ESTABLISHMENT:..... G-3  
DELAY IN RIGHT OF ENTRY: ..... G-4  
MAJOR CONTRACT ITEMS: ..... G-4  
SPECIALTY ITEMS:..... G-4  
FUEL PRICE ADJUSTMENT:..... G-5  
SCHEDULE OF ESTIMATED COMPLETION PROGRESS:..... G-5  
DISADVANTAGED BUSINESS ENTERPRISE: ..... G-6  
CERTIFICATION FOR FEDERAL-AID CONTRACTS: ..... G-19  
CONTRACTOR'S LICENSE REQUIREMENTS: ..... G-20  
U.S. DEPARTMENT OF TRANSPORTATION HOTLINE: ..... G-20  
SUBSURFACE INFORMATION:..... G-20  
LOCATING EXISTING UNDERGROUND UTILITIES:..... G-21  
VALUE ENGINEERING PROPOSAL: ..... G-21  
RESOURCE CONSERVATION AND ENV. SUSTAINABLE PRACTICES:..... G-22  
DOMESTIC STEEL: ..... G-23  
MAINTENANCE OF THE PROJECT: ..... G-23  
TWELVE MONTH GUARANTEE: ..... G-24  
GIFTS FROM VENDORS AND CONTRACTORS: ..... G-24  
LIABILITY INSURANCE:..... G-25  
EROSION AND SEDIMENT CONTROL/STORMWATER CERTIFICATION: ..... G-25  
PROCEDURE FOR MONITORING BORROW PIT DISCHARGE:..... G-30  
EMPLOYMENT:..... G-32  
STATE HIGHWAY ADMINISTRATOR TITLE CHANGE:..... G-32  
SUBLETTING OF CONTRACT: ..... G-33

ROADWAY..... R-1

**STANDARD SPECIAL PROVISIONS**

AVAILABILITY FUNDS – TERMINATION OF CONTRACTS .....SSP-1  
NCDOT GENERAL SEED SPECIFICATION FOR SEED QUALITY .....SSP-2  
ERRATA.....SSP-5  
PLANT AND PEST QUARANTINES .....SSP-7  
AWARD OF CONTRACT.....SSP-8  
MINORITY AND FEMALE EMPLOYMENT REQUIREMENTS .....SSP-9



REQUIRED CONTRACT PROVISIONS FEDERAL-AID CONST. CONTRACTS .....SSP-12  
 ON-THE-JOB TRAINING .....SSP-21  
 NAME CHANGE FOR NCDENR .....SSP-24  
 MINIMUM WAGES ..... SSP-25

**UNIT PROJECT SPECIAL PROVISIONS**

UTILITY CONSTRUCTION .....UC-1  
 UTILITY BY OTHERS .....UBO-1  
 EROSION CONTROL ..... EC-1  
 TRAFFIC SIGNALS .....TS-1  
 STRUCTURE / CULVERTS .....ST-1

**PERMITS** ..... P-1

**PROPOSAL ITEM SHEET**

ITEM SHEET(S) (TAN SHEETS)

**PROJECT SPECIAL PROVISIONS****GENERAL****CONTRACT TIME AND LIQUIDATED DAMAGES:**

(8-15-00) (Rev. 12-18-07)

108

SP1 G07 A

The date of availability for this contract is **February 29, 2016**, except that work in jurisdictional waters and wetlands shall not begin until a meeting between the DOT, Regulatory Agencies, and the Contractor is held as stipulated in the permits contained elsewhere in this proposal. This delay in availability has been considered in determining the contract time for this project.

The completion date for this contract is **May 30, 2017**.

Except where otherwise provided by the contract, observation periods required by the contract will not be a part of the work to be completed by the completion date and/or intermediate contract times stated in the contract. The acceptable completion of the observation periods that extend beyond the final completion date shall be a part of the work covered by the performance and payment bonds.

The liquidated damages for this contract are **Two Hundred Dollars (\$ 200.00)** per calendar day. These liquidated damages will not be cumulative with any liquidated damages which may become chargeable under Intermediate Contract Time Number 1.

**INTERMEDIATE CONTRACT TIME NUMBER 1 AND LIQUIDATED DAMAGES:**

(7-1-95) (Rev. 2-21-12)

108

SP1 G13 A

Except for that work required under the Project Special Provisions entitled *Planting, Reforestation* and/or *Permanent Vegetation Establishment*, included elsewhere in this proposal, the Contractor will be required to complete all work included in this contract and shall place and maintain traffic on same.

The date of availability for this intermediate contract time is **February 29, 2016**.

The completion date for this intermediate contract time is **December 1, 2016**.

The liquidated damages for this intermediate contract time are **Seven Hundred Fifty Dollars (\$ 750.00)** per calendar day.

Upon apparent completion of all the work required to be completed by this intermediate date, a final inspection will be held in accordance with Article 105-17 and upon acceptance, the Department will assume responsibility for the maintenance of all work except *Planting, Reforestation* and/or *Permanent Vegetation Establishment*. The Contractor will be responsible for and shall make corrections of all damages to the completed roadway caused by his planting operations, whether occurring prior to or after placing traffic through the project.

**INTERMEDIATE CONTRACT TIME NUMBER 2 AND LIQUIDATED DAMAGES:**

(2-20-07)

108

SPI G14 A

The Contractor shall complete the required work of installing, maintaining, and removing the traffic control devices for lane closures and restoring traffic to the existing traffic pattern. The Contractor shall not close or narrow a lane of traffic on **SR-1008 (S. Indian Trail Road)**, **SR-1009 (Old Monroe Road)**, and **SR-1371 (Southfork Road)** during the following time restrictions:

**DAY AND TIME RESTRICTIONS**

**Monday thru Friday**  
**7:00 A.M. to 9:00 A.M.**  
**and**  
**4:00 P.M. to 7:00 P.M.**

In addition, the Contractor shall not close or narrow a lane of traffic on **SR-1008 (S. Indian Trail Road)**, **SR-1009 (Old Monroe Road)**, and **SR-1371 (Southfork Road)** detain and/or alter the traffic flow on or during holidays, holiday weekends, special events, or any other time when traffic is unusually heavy, including the following schedules:

**HOLIDAY AND HOLIDAY WEEKEND LANE CLOSURE RESTRICTIONS**

1. For **unexpected occurrence** that creates unusually high traffic volumes, as directed by the Engineer.
2. For **New Year's Day**, between the hours of **7:00 A.M.** December 31st and **7:00 P.M.** January 2nd. If New Year's Day is on a Friday, Saturday, Sunday or Monday, then until **7:00 P.M.** the following Tuesday.
3. For **Easter**, between the hours of **7:00 A.M.** Thursday and **7:00 P.M.** Monday.
4. For **Memorial Day**, between the hours of **7:00 A.M.** Friday and **7:00 P.M.** Tuesday.
5. For **Independence Day**, between the hours of **7:00 A.M.** the day before Independence Day and **7:00 P.M.** the day after Independence Day.  
  
If **Independence Day** is on a Friday, Saturday, Sunday or Monday, then between the hours of **7:00 A.M.** the Thursday before Independence Day and **7:00 P.M.** the Tuesday after Independence Day.
6. For **Labor Day**, between the hours of **7:00 A.M.** Friday and **7:00 P.M.** Tuesday.
7. For **Thanksgiving Day**, between the hours of **7:00 A.M.** Tuesday and **7:00 P.M.** Monday.
8. For **Christmas**, between the hours of **7:00 A.M.** the Friday before the week of Christmas Day and **7:00 P.M.** the following Tuesday after the week of Christmas Day.

Holidays and holiday weekends shall include New Year's, Easter, Memorial Day, Independence Day, Labor Day, Thanksgiving, and Christmas. The Contractor shall schedule his work so that lane closures will not be required during these periods, unless otherwise directed by the Engineer.

The time of availability for this intermediate contract work shall be the time the Contractor begins to install all traffic control devices for lane closures according to the time restrictions listed herein.

The completion time for this intermediate contract work shall be the time the Contractor is required to complete the removal of all traffic control devices for lane closures according to the time restrictions stated above and place traffic in the existing traffic pattern.

The liquidated damages are **Five Hundred Dollars (\$ 500.00)** per fifteen (15) minute time period.

**INTERMEDIATE CONTRACT TIME NUMBER 3 AND LIQUIDATED DAMAGES:**

(6-18-13)

108

SP1 G14 L

The Contractor shall complete the work required of **Phase II, Step #1 thru Phase II, Step #4** as shown on Sheet **TMP-3** and shall place and maintain traffic on same.

The date of availability for this intermediate contract time is **June 10, 2016**.

The completion date for this intermediate contract time is **November 7, 2016**.

The liquidated damages are **Two Thousand Five Hundred Dollars (\$ 2,500.00)** per calendar day.

**PERMANENT VEGETATION ESTABLISHMENT:**

(2-16-12) (Rev. 10-15-13)

104

SP1 G16

Establish a permanent stand of the vegetation mixture shown in the contract. During the period between initial vegetation planting and final project acceptance, perform all work necessary to establish permanent vegetation on all erodible areas within the project limits, as well as, in borrow and waste pits. This work shall include erosion control device maintenance and installation, repair seeding and mulching, supplemental seeding and mulching, mowing, and fertilizer topdressing, as directed. All work shall be performed in accordance with the applicable section of the *2012 Standard Specifications*. All work required for initial vegetation planting shall be performed as a part of the work necessary for the completion and acceptance of the Intermediate Contract Time (ICT). Between the time of ICT and Final Project acceptance, or otherwise referred to as the vegetation establishment period, the Department will be responsible for preparing the required National Pollutant Discharge Elimination System (NPDES) inspection records.

Once the Engineer has determined that the permanent vegetation establishment requirement has been achieved at an 80% vegetation density (the amount of established vegetation per given area

to stabilize the soil) and no erodible areas exist within the project limits, the Contractor will be notified to remove the remaining erosion control devices that are no longer needed. The Contractor will be responsible for, and shall correct any areas disturbed by operations performed in permanent vegetation establishment and the removal of temporary erosion control measures, whether occurring prior to or after placing traffic on the project.

Payment for *Response for Erosion Control, Seeding and Mulching, Repair Seeding, Supplemental Seeding, Mowing, Fertilizer Topdressing, Silt Excavation, and Stone for Erosion Control* will be made at contract unit prices for the affected items. Work required that is not represented by contract line items will be paid in accordance with Articles 104-7 or 104-3 of the *2012 Standard Specifications*. No additional compensation will be made for maintenance and removal of temporary erosion control items.

**DELAY IN RIGHT OF ENTRY:**

(7-1-95) (Rev. 7-15-14)

108

SP1 G22

The Contractor will not be allowed right of entry to the following parcel(s) prior to the listed date(s) unless otherwise permitted by the Engineer.

<b><u>Parcel No.</u></b>	<b><u>Property Owner</u></b>	<b><u>Date</u></b>
19	Killough-Rohleder Holding Company, LLC	1-15-16

**MAJOR CONTRACT ITEMS:**

(2-19-02)

104

SP1 G28

The following listed items are the major contract items for this contract (see Article 104-5 of the *2012 Standard Specifications*):

<b>Line #</b>	<b>Description</b>
27	Asphalt Concrete Surface Course, Type S9.5B
155	Class A Concrete (Culvert)

**SPECIALTY ITEMS:**

(7-1-95)(Rev. 1-17-12)

108-6

SP1 G37

Items listed below will be the specialty items for this contract (see Article 108-6 of the *2012 Standard Specifications*).

<b>Line #</b>	<b>Description</b>
54-57	Guardrail
58	Fencing
63-65	Signing
74-79	Long-Life Pavement Markings
84	Permanent Pavement Markers
85-99	Utility Construction
100-129	Erosion Control
131-151	Signals/ITS System

**FUEL PRICE ADJUSTMENT:**

(11-15-05) (Rev. 2-18-14)

109-8

SP1 G43

Revise the *2012 Standard Specifications* as follows:

**Page 1-83, Article 109-8, Fuel Price Adjustments**, add the following:

The base index price for DIESEL #2 FUEL is \$ **1.4384** per gallon. Where any of the following are included as pay items in the contract, they will be eligible for fuel price adjustment.

The pay items and the fuel factor used in calculating adjustments to be made will be as follows:

Description	Units	Fuel Usage Factor Diesel
Unclassified Excavation	Gal/CY	0.29
Borrow Excavation	Gal/CY	0.29
Class IV Subgrade Stabilization	Gal/Ton	0.55
Aggregate Base Course	Gal/Ton	0.55
Sub-Ballast	Gal/Ton	0.55
Asphalt Concrete Base Course, Type ____	Gal/Ton	2.90
Asphalt Concrete Intermediate Course, Type ____	Gal/Ton	2.90
Asphalt Concrete Surface Course, Type ____	Gal/Ton	2.90
Open-Graded Asphalt Friction Course	Gal/Ton	2.90
Permeable Asphalt Drainage Course, Type ____	Gal/Ton	2.90
Sand Asphalt Surface Course, Type ____	Gal/Ton	2.90
Aggregate for Cement Treated Base Course	Gal/Ton	0.55
Portland Cement for Cement Treated Base Course	Gal/Ton	0.55
__" Portland Cement Concrete Pavement	Gal/SY	0.245
Concrete Shoulders Adjacent to __" Pavement	Gal/SY	0.245

**SCHEDULE OF ESTIMATED COMPLETION PROGRESS:**

(7-15-08) (Rev. 5-19-15)

108-2

SP1 G58

The Contractor's attention is directed to the Standard Special Provision entitled *Availability of Funds Termination of Contracts* included elsewhere in this proposal. The Department of Transportation's schedule of estimated completion progress for this project as required by that Standard Special Provision is as follows:

2016	(7/01/15 - 6/30/16)	<b>58</b> % of Total Amount Bid
2017	(7/01/16 - 6/30/17)	<b>42</b> % of Total Amount Bid

The Contractor shall also furnish his own progress schedule in accordance with Article 108-2 of the *2012 Standard Specifications*. Any acceleration of the progress as shown by the Contractor's progress schedule over the progress as shown above shall be subject to the approval of the Engineer.

**DISADVANTAGED BUSINESS ENTERPRISE:**

(10-16-07)(Rev. 12-17-13)

102-15(J)

SP1 G61

**Description**

The purpose of this Special Provision is to carry out the U.S. Department of Transportation's policy of ensuring nondiscrimination in the award and administration of contracts financed in whole or in part with Federal funds. This provision is guided by 49 CFR Part 26.

**Definitions**

*Additional DBE Subcontractors* - Any DBE submitted at the time of bid that will not be used to meet the DBE goal. No submittal of a Letter of Intent is required.

*Committed DBE Subcontractor* - Any DBE submitted at the time of bid that is being used to meet the DBE goal by submission of a Letter of Intent. Or any DBE used as a replacement for a previously committed DBE firm.

*Contract Goal Requirement* - The approved DBE participation at time of award, but not greater than the advertised contract goal.

*DBE Goal* - A portion of the total contract, expressed as a percentage, that is to be performed by committed DBE subcontractor(s).

*Disadvantaged Business Enterprise (DBE)* - A firm certified as a Disadvantaged Business Enterprise through the North Carolina Unified Certification Program.

*Goal Confirmation Letter* - Written documentation from the Department to the bidder confirming the Contractor's approved, committed DBE participation along with a listing of the committed DBE firms.

*Manufacturer* - A firm that operates or maintains a factory or establishment that produces on the premises, the materials or supplies obtained by the Contractor.

*Regular Dealer* - A firm that owns, operates, or maintains a store, warehouse, or other establishment in which the materials or supplies required for the performance of the contract are bought, kept in stock, and regularly sold to the public in the usual course of business. A regular dealer engages in, as its principal business and in its own name, the purchase and sale or lease of the products in question. A regular dealer in such bulk items as steel, cement, gravel, stone, and petroleum products need not keep such products in stock, if it owns and operates distribution equipment for the products. Brokers and packagers are not regarded as manufacturers or regular dealers within the meaning of this section.

*North Carolina Unified Certification Program (NCUCP)* - A program that provides comprehensive services and information to applicants for DBE certification, such that an applicant is required to apply only once for a DBE certification that will be honored by all

recipients of USDOT funds in the state and not limited to the Department of Transportation only. The Certification Program is in accordance with 49 CFR Part 26.

*United States Department of Transportation (USDOT)* - Federal agency responsible for issuing regulations (49 CFR Part 26) and official guidance for the DBE program.

### **Forms and Websites Referenced in this Provision**

*DBE Payment Tracking System* - On-line system in which the Contractor enters the payments made to DBE subcontractors who have performed work on the project.  
<https://apps.dot.state.nc.us/Vendor/PaymentTracking/>

*DBE-IS Subcontractor Payment Information* - Form for reporting the payments made to all DBE firms working on the project. This form is for paper bid projects only.  
<http://www.ncdot.org/doh/forms/files/DBE-IS.xls>

*RF-1 DBE Replacement Request Form* - Form for replacing a committed DBE.  
<http://connect.ncdot.gov/projects/construction/Construction%20Forms/DBE%20MBE%20WBE%20Replacement%20Request%20Form.pdf>

*SAF Subcontract Approval Form* - Form required for approval to sublet the contract.  
<http://connect.ncdot.gov/projects/construction/Construction%20Forms/Subcontract%20Approval%20Form%20Rev.%202012.zip>

*JC-1 Joint Check Notification Form* - Form and procedures for joint check notification. The form acts as a written joint check agreement among the parties providing full and prompt disclosure of the expected use of joint checks.  
<http://connect.ncdot.gov/projects/construction/Construction%20Forms/Joint%20Check%20Notification%20Form.pdf>

*Letter of Intent* - Form signed by the Contractor and the DBE subcontractor, manufacturer or regular dealer that affirms that a portion of said contract is going to be performed by the signed DBE for the amount listed at the time of bid.  
<http://connect.ncdot.gov/letting/LetCentral/Letter%20of%20Intent%20to%20Perform%20as%20a%20Subcontractor.pdf>

*Listing of DBE Subcontractors Form* - Form for entering DBE subcontractors on a project that will meet this DBE goal. This form is for paper bids only.  
[http://connect.ncdot.gov/municipalities/Bid%20Proposals%20for%20LGA%20Content/08%20DBE%20Subcontractors%20\(Federal\).docx](http://connect.ncdot.gov/municipalities/Bid%20Proposals%20for%20LGA%20Content/08%20DBE%20Subcontractors%20(Federal).docx)

*Subcontractor Quote Comparison Sheet* - Spreadsheet for showing all subcontractor quotes in the work areas where DBEs quoted on the project. This sheet is submitted with good faith effort packages.  
<http://connect.ncdot.gov/business/SmallBusiness/Documents/DBE%20Subcontractor%20Quote%20Comparison%20Example.xls>



**DBE Goal**

The following DBE goal for participation by Disadvantaged Business Enterprises is established for this contract:

Disadvantaged Business Enterprises **11.0 %**

- (A) *If the DBE goal is more than zero*, the Contractor shall exercise all necessary and reasonable steps to ensure that DBEs participate in at least the percent of the contract as set forth above as the DBE goal.
- (B) *If the DBE goal is zero*, the Contractor shall make an effort to recruit and use DBEs during the performance of the contract. Any DBE participation obtained shall be reported to the Department.

**Directory of Transportation Firms (Directory)**

Real-time information is available about firms doing business with the Department and firms that are certified through NCUCP in the Directory of Transportation Firms. Only firms identified in the Directory as DBE certified shall be used to meet the DBE goal. The Directory can be found at the following link. <https://partner.ncdot.gov/VendorDirectory/default.html>

The listing of an individual firm in the directory shall not be construed as an endorsement of the firm's capability to perform certain work.

**Listing of DBE Subcontractors**

At the time of bid, bidders shall submit all DBE participation that they anticipate to use during the life of the contract. Only those identified to meet the DBE goal will be considered committed, even though the listing shall include both committed DBE subcontractors and additional DBE subcontractors. Additional DBE subcontractor participation submitted at the time of bid will be used toward the Department's overall race-neutral goal. Only those firms with current DBE certification at the time of bid opening will be acceptable for listing in the bidder's submittal of DBE participation. The Contractor shall indicate the following required information:

- (A) Electronic Bids

Bidders shall submit a listing of DBE participation in the appropriate section of Expedite, the bidding software of Bid Express<sup>®</sup>.

- (1) Submit the names and addresses of DBE firms identified to participate in the contract. If the bidder uses the updated listing of DBE firms shown in Expedite, the bidder may use the dropdown menu to access the name and address of the DBE firm.

- (2) Submit the contract line numbers of work to be performed by each DBE firm. When no figures or firms are entered, the bidder will be considered to have no DBE participation.
  - (3) The bidder shall be responsible for ensuring that the DBE is certified at the time of bid by checking the Directory of Transportation Firms. If the firm is not certified at the time of the bid-letting, that DBE's participation will not count towards achieving the DBE goal.
- (B) Paper Bids
- (1) *If the DBE goal is more than zero,*
    - (a) Bidders, at the time the bid proposal is submitted, shall submit a listing of DBE participation, including the names and addresses on *Listing of DBE Subcontractors* contained elsewhere in the contract documents in order for the bid to be considered responsive. Bidders shall indicate the total dollar value of the DBE participation for the contract.
    - (b) If bidders have no DBE participation, they shall indicate this on the *Listing of DBE Subcontractors* by entering the word "None" or the number "0." This form shall be completed in its entirety. **Blank forms will not be deemed to represent zero participation.** Bids submitted that do not have DBE participation indicated on the appropriate form will not be read publicly during the opening of bids. The Department will not consider these bids for award and the proposal will be rejected.
    - (c) The bidder shall be responsible for ensuring that the DBE is certified at the time of bid by checking the Directory of Transportation Firms. If the firm is not certified at the time of the bid-letting, that DBE's participation will not count towards achieving the corresponding goal.
  - (2) *If the DBE goal is zero,* entries on the *Listing of DBE Subcontractors* are not required for the zero goal, however any DBE participation that is achieved during the project shall be reported in accordance with requirements contained elsewhere in the special provision.

### **DBE Prime Contractor**

When a certified DBE firm bids on a contract that contains a DBE goal, the DBE firm is responsible for meeting the goal or making good faith efforts to meet the goal, just like any other bidder. In most cases, a DBE bidder on a contract will meet the DBE goal by virtue of the work it performs on the contract with its own forces. However, all the work that is performed by the DBE bidder and any other DBE subcontractors will count toward the DBE goal. The DBE

bidder shall list itself along with any DBE subcontractors, if any, in order to receive credit toward the DBE goal.

For example, if the DBE goal is 45% and the DBE bidder will only perform 40% of the contract work, the prime will list itself at 40%, and the additional 5% shall be obtained through additional DBE participation with DBE subcontractors or documented through a good faith effort.

DBE prime contractors shall also follow Sections A and B listed under *Listing of DBE Subcontractor* just as a non-DBE bidder would.

### **Written Documentation – Letter of Intent**

The bidder shall submit written documentation for each DBE that will be used to meet the DBE goal of the contract, indicating the bidder's commitment to use the DBE in the contract. This documentation shall be submitted on the Department's form titled *Letter of Intent*.

The documentation shall be received in the office of the State Contractor Utilization Engineer or at DBE@ncdot.gov no later than 12:00 noon of the sixth calendar day following opening of bids, unless the sixth day falls on an official state holiday. In that situation, it is due in the office of the State Contractor Utilization Engineer no later than 12:00 noon on the next official state business day.

If the bidder fails to submit the Letter of Intent from each committed DBE to be used toward the DBE goal, or if the form is incomplete (i.e. both signatures are not present), the DBE participation will not count toward meeting the DBE goal. If the lack of this participation drops the commitment below the DBE goal, the Contractor shall submit evidence of good faith efforts, completed in its entirety, to the State Contractor Utilization Engineer or DBE@ncdot.gov no later than 12:00 noon on the eighth calendar day following opening of bids, unless the eighth day falls on an official state holiday. In that situation, it is due in the office of the State Contractor Utilization Engineer no later than 12:00 noon on the next official state business day.

### **Submission of Good Faith Effort**

If the bidder fails to meet or exceed the DBE goal, the apparent lowest responsive bidder shall submit to the Department documentation of adequate good faith efforts made to reach the DBE goal.

A hard copy and an electronic copy of this information shall be received in the office of the State Contractor Utilization Engineer or at DBE@ncdot.gov no later than 12:00 noon of the sixth calendar day following opening of bids unless the sixth day falls on an official state holiday. In that situation, it is due in the office of the State Contractor Utilization Engineer the next official state business day. If the contractor cannot send the information electronically, then one complete set and 9 copies of this information shall be received under the same time constraints above.

Note: Where the information submitted includes repetitious solicitation letters, it will be acceptable to submit a representative letter along with a distribution list of the firms that were solicited. Documentation of DBE quotations shall be a part of the good faith effort submittal. This documentation may include written subcontractor quotations, telephone log notations of verbal quotations, or other types of quotation documentation.

### **Consideration of Good Faith Effort for Projects with DBE Goals More Than Zero**

Adequate good faith efforts mean that the bidder took all necessary and reasonable steps to achieve the goal which, by their scope, intensity, and appropriateness, could reasonably be expected to obtain sufficient DBE participation. Adequate good faith efforts also mean that the bidder actively and aggressively sought DBE participation. Mere *pro forma* efforts are not considered good faith efforts.

The Department will consider the quality, quantity, and intensity of the different kinds of efforts a bidder has made. Listed below are examples of the types of actions a bidder will take in making a good faith effort to meet the goal and are not intended to be exclusive or exhaustive, nor is it intended to be a mandatory checklist.

- (A) Soliciting through all reasonable and available means (e.g. attendance at pre-bid meetings, advertising, written notices, use of verifiable electronic means through the use of the NCDOT Directory of Transportation Firms) the interest of all certified DBEs who have the capability to perform the work of the contract. The bidder must solicit this interest within at least 10 days prior to bid opening to allow the DBEs to respond to the solicitation. Solicitation shall provide the opportunity to DBEs within the Division and surrounding Divisions where the project is located. The bidder must determine with certainty if the DBEs are interested by taking appropriate steps to follow up initial solicitations.
- (B) Selecting portions of the work to be performed by DBEs in order to increase the likelihood that the DBE goals will be achieved.
  - (1) Where appropriate, break out contract work items into economically feasible units to facilitate DBE participation, even when the prime contractor might otherwise prefer to perform these work items with its own forces.
  - (2) Negotiate with subcontractors to assume part of the responsibility to meet the contract DBE goal when the work to be sublet includes potential for DBE participation (2<sup>nd</sup> and 3<sup>rd</sup> tier subcontractors).
- (C) Providing interested DBEs with adequate information about the plans, specifications, and requirements of the contract in a timely manner to assist them in responding to a solicitation.
- (D) (1) Negotiating in good faith with interested DBEs. It is the bidder's responsibility to

make a portion of the work available to DBE subcontractors and suppliers and to select those portions of the work or material needs consistent with the available DBE subcontractors and suppliers, so as to facilitate DBE participation. Evidence of such negotiation includes the names, addresses, and telephone numbers of DBEs that were considered; a description of the information provided regarding the plans and specifications for the work selected for subcontracting; and evidence as to why additional agreements could not be reached for DBEs to perform the work.

- (2) A bidder using good business judgment would consider a number of factors in negotiating with subcontractors, including DBE subcontractors, and would take a firm's price and capabilities as well as contract goals into consideration. However, the fact that there may be some additional costs involved in finding and using DBEs is not in itself sufficient reason for a bidder's failure to meet the contract DBE goal, as long as such costs are reasonable. Also, the ability or desire of a prime contractor to perform the work of a contract with its own organization does not relieve the bidder of the responsibility to make good faith efforts. Bidding contractors are not, however, required to accept higher quotes from DBEs if the price difference is excessive or unreasonable.
- (E) Not rejecting DBEs as being unqualified without sound reasons based on a thorough investigation of their capabilities. The bidder's standing within its industry, membership in specific groups, organizations, or associates and political or social affiliations (for example, union vs. non-union employee status) are not legitimate causes for the rejection or non-solicitation of bids in the bidder's efforts to meet the project goal.
- (F) Making efforts to assist interested DBEs in obtaining bonding, lines of credit, or insurance as required by the recipient or bidder.
- (G) Making efforts to assist interested DBEs in obtaining necessary equipment, supplies, materials, or related assistance or services.
- (H) Effectively using the services of available minority/women community organizations; minority/women contractors' groups; Federal, State, and local minority/women business assistance offices; and other organizations as allowed on a case-by-case basis to provide assistance in the recruitment and placement of DBEs. Contact within 7 days from the bid opening the Business Development Manager in the Business Opportunity and Work Force Development Unit to give notification of the bidder's inability to get DBE quotes.
- (I) Any other evidence that the bidder submits which shows that the bidder has made reasonable good faith efforts to meet the DBE goal.

In addition, the Department may take into account the following:

- (1) Whether the bidder's documentation reflects a clear and realistic plan for achieving the DBE goal.

- (2) The bidders' past performance in meeting the DBE goals.
- (3) The performance of other bidders in meeting the DBE goal. For example, when the apparent successful bidder fails to meet the DBE goal, but others meet it, you may reasonably raise the question of whether, with additional reasonable efforts the apparent successful bidder could have met the goal. If the apparent successful bidder fails to meet the DBE goal, but meets or exceeds the average DBE participation obtained by other bidders, the Department may view this, in conjunction with other factors, as evidence of the apparent successful bidder having made a good faith effort.

If the Department does not award the contract to the apparent lowest responsive bidder, the Department reserves the right to award the contract to the next lowest responsive bidder that can satisfy to the Department that the DBE goal can be met or that an adequate good faith effort has been made to meet the DBE goal.

### **Non-Good Faith Appeal**

The State Contractor Utilization Engineer will notify the contractor verbally and in writing of non-good faith. A contractor may appeal a determination of non-good faith made by the Goal Compliance Committee. If a contractor wishes to appeal the determination made by the Committee, they shall provide written notification to the State Contractual Services Engineer or at DBE@ncdot.gov. The appeal shall be made within 2 business days of notification of the determination of non-good faith.

### **Counting DBE Participation Toward Meeting DBE Goal**

#### **(A) Participation**

The total dollar value of the participation by a committed DBE will be counted toward the contract goal requirement. The total dollar value of participation by a committed DBE will be based upon the value of work actually performed by the DBE and the actual payments to DBE firms by the Contractor.

#### **(B) Joint Checks**

Prior notification of joint check use shall be required when counting DBE participation for services or purchases that involves the use of a joint check. Notification shall be through submission of Form JC-1 (*Joint Check Notification Form*) and the use of joint checks shall be in accordance with the Department's Joint Check Procedures.

#### **(C) Subcontracts (Non-Trucking)**

A DBE may enter into subcontracts. Work that a DBE subcontracts to another DBE firm may be counted toward the contract goal requirement. Work that a DBE subcontracts to

a non-DBE firm does not count toward the contract goal requirement. If a DBE contractor or subcontractor subcontracts a significantly greater portion of the work of the contract than would be expected on the basis of standard industry practices, it shall be presumed that the DBE is not performing a commercially useful function. The DBE may present evidence to rebut this presumption to the Department. The Department's decision on the rebuttal of this presumption is subject to review by the Federal Highway Administration but is not administratively appealable to USDOT.

(D) Joint Venture

When a DBE performs as a participant in a joint venture, the Contractor may count toward its contract goal requirement a portion of the total value of participation with the DBE in the joint venture, that portion of the total dollar value being a distinct clearly defined portion of work that the DBE performs with its forces.

(E) Suppliers

A contractor may count toward its DBE requirement 60 percent of its expenditures for materials and supplies required to complete the contract and obtained from a DBE regular dealer and 100 percent of such expenditures from a DBE manufacturer.

(F) Manufacturers and Regular Dealers

A contractor may count toward its DBE requirement the following expenditures to DBE firms that are not manufacturers or regular dealers:

- (1) The fees or commissions charged by a DBE firm for providing a *bona fide* service, such as professional, technical, consultant, or managerial services, or for providing bonds or insurance specifically required for the performance of a DOT-assisted contract, provided the fees or commissions are determined to be reasonable and not excessive as compared with fees and commissions customarily allowed for similar services.
- (2) With respect to materials or supplies purchased from a DBE, which is neither a manufacturer nor a regular dealer, count the entire amount of fees or commissions charged for assistance in the procurement of the materials and supplies, or fees or transportation charges for the delivery of materials or supplies required on a job site (but not the cost of the materials and supplies themselves), provided the fees are determined to be reasonable and not excessive as compared with fees customarily allowed for similar services.

**Commercially Useful Function****(A) DBE Utilization**

The Contractor may count toward its contract goal requirement only expenditures to DBEs that perform a commercially useful function in the work of a contract. A DBE performs a commercially useful function when it is responsible for execution of the work of the contract and is carrying out its responsibilities by actually performing, managing, and supervising the work involved. To perform a commercially useful function, the DBE shall also be responsible with respect to materials and supplies used on the contract, for negotiating price, determining quality and quantity, ordering the material and installing (where applicable) and paying for the material itself. To determine whether a DBE is performing a commercially useful function, the Department will evaluate the amount of work subcontracted, industry practices, whether the amount the firm is to be paid under the contract is commensurate with the work it is actually performing and the DBE credit claimed for its performance of the work, and any other relevant factors.

**(B) DBE Utilization in Trucking**

The following factors will be used to determine if a DBE trucking firm is performing a commercially useful function:

- (1) The DBE shall be responsible for the management and supervision of the entire trucking operation for which it is responsible on a particular contract, and there shall not be a contrived arrangement for the purpose of meeting DBE goals.
- (2) The DBE shall itself own and operate at least one fully licensed, insured, and operational truck used on the contract.
- (3) The DBE receives credit for the total value of the transportation services it provides on the contract using trucks it owns, insures, and operates using drivers it employs.
- (4) The DBE may subcontract the work to another DBE firm, including an owner-operator who is certified as a DBE. The DBE who subcontracts work to another DBE receives credit for the total value of the transportation services the subcontracted DBE provides on the contract.
- (5) The DBE may also subcontract the work to a non-DBE firm, including from an owner-operator. The DBE who subcontracts the work to a non-DBE is entitled to credit for the total value of transportation services provided by the non-DBE subcontractor not to exceed the value of transportation services provided by DBE-owned trucks on the contract. Additional participation by non-DBE subcontractors receives credit only for the fee or commission it receives as a result of the subcontract arrangement. The value of services performed under



subcontract agreements between the DBE and the Contractor will not count towards the DBE contract requirement.

- (6) A DBE may lease truck(s) from an established equipment leasing business open to the general public. The lease must indicate that the DBE has exclusive use of and control over the truck. This requirement does not preclude the leased truck from working for others during the term of the lease with the consent of the DBE, so long as the lease gives the DBE absolute priority for use of the leased truck. This type of lease may count toward the DBE's credit as long as the driver is under the DBE's payroll.
- (7) Subcontracted/leased trucks shall display clearly on the dashboard the name of the DBE that they are subcontracted/leased to and their own company name if it is not identified on the truck itself. Magnetic door signs are not permitted.

### **DBE Replacement**

When a Contractor has relied on a commitment to a DBE firm (or an approved substitute DBE firm) to meet all or part of a contract goal requirement, the contractor shall not terminate the DBE for convenience. This includes, but is not limited to, instances in which the Contractor seeks to perform the work of the terminated subcontractor with another DBE subcontractor, a non-DBE subcontractor, or with the Contractor's own forces or those of an affiliate. A DBE may only be terminated after receiving the Engineer's written approval based upon a finding of good cause for the termination.

All requests for replacement of a committed DBE firm shall be submitted to the Engineer for approval on Form RF-1 (*DBE Replacement Request*). If the Contractor fails to follow this procedure, the Contractor may be disqualified from further bidding for a period of up to 6 months.

The Contractor shall comply with the following for replacement of a committed DBE:

#### **(A) Performance Related Replacement**

When a committed DBE is terminated for good cause as stated above, an additional DBE that was submitted at the time of bid may be used to fulfill the DBE commitment. A good faith effort will only be required for removing a committed DBE if there were no additional DBEs submitted at the time of bid to cover the same amount of work as the DBE that was terminated.

If a replacement DBE is not found that can perform at least the same amount of work as the terminated DBE, the Contractor shall submit a good faith effort documenting the steps taken. Such documentation shall include, but not be limited to, the following:

- (1) Copies of written notification to DBEs that their interest is solicited in contracting the work defaulted by the previous DBE or in subcontracting other items of work in the contract.
  - (2) Efforts to negotiate with DBEs for specific subbids including, at a minimum:
    - (a) The names, addresses, and telephone numbers of DBEs who were contacted.
    - (b) A description of the information provided to DBEs regarding the plans and specifications for portions of the work to be performed.
  - (3) A list of reasons why DBE quotes were not accepted.
  - (4) Efforts made to assist the DBEs contacted, if needed, in obtaining bonding or insurance required by the Contractor.
- (B) Decertification Replacement
- (1) When a committed DBE is decertified by the Department after the SAF (*Subcontract Approval Form*) has been received by the Department, the Department will not require the Contractor to solicit replacement DBE participation equal to the remaining work to be performed by the decertified firm. The participation equal to the remaining work performed by the decertified firm will count toward the contract goal requirement.
  - (2) When a committed DBE is decertified prior to the Department receiving the SAF (*Subcontract Approval Form*) for the named DBE firm, the Contractor shall take all necessary and reasonable steps to replace the DBE subcontractor with another DBE subcontractor to perform at least the same amount of work to meet the DBE goal requirement. If a DBE firm is not found to do the same amount of work, a good faith effort must be submitted to NCDOT (see A herein for required documentation).

### **Changes in the Work**

When the Engineer makes changes that result in the reduction or elimination of work to be performed by a committed DBE, the Contractor will not be required to seek additional participation. When the Engineer makes changes that result in additional work to be performed by a DBE based upon the Contractor's commitment, the DBE shall participate in additional work to the same extent as the DBE participated in the original contract work.

When the Engineer makes changes that result in extra work, which has more than a minimal impact on the contract amount, the Contractor shall seek additional participation by DBEs unless otherwise approved by the Engineer.

When the Engineer makes changes that result in an alteration of plans or details of construction, and a portion or all of the work had been expected to be performed by a committed DBE, the Contractor shall seek participation by DBEs unless otherwise approved by the Engineer.

When the Contractor requests changes in the work that result in the reduction or elimination of work that the Contractor committed to be performed by a DBE, the Contractor shall seek additional participation by DBEs equal to the reduced DBE participation caused by the changes.

### **Reports and Documentation**

A SAF (*Subcontract Approval Form*) shall be submitted for all work which is to be performed by a DBE subcontractor. The Department reserves the right to require copies of actual subcontract agreements involving DBE subcontractors.

When using transportation services to meet the contract commitment, the Contractor shall submit a proposed trucking plan in addition to the SAF. The plan shall be submitted prior to beginning construction on the project. The plan shall include the names of all trucking firms proposed for use, their certification type(s), the number of trucks owned by the firm, as well as the individual truck identification numbers, and the line item(s) being performed.

Within 30 calendar days of entering into an agreement with a DBE for materials, supplies or services, not otherwise documented by the SAF as specified above, the Contractor shall furnish the Engineer a copy of the agreement. The documentation shall also indicate the percentage (60% or 100%) of expenditures claimed for DBE credit.

### **Reporting Disadvantaged Business Enterprise Participation**

The Contractor shall provide the Engineer with an accounting of payments made to all DBE firms, including material suppliers and contractors at all levels (prime, subcontractor, or second tier subcontractor). This accounting shall be furnished to the Engineer for any given month by the end of the following month. Failure to submit this information accordingly may result in the following action:

- (A) Withholding of money due in the next partial pay estimate; or
- (B) Removal of an approved contractor from the prequalified bidders' list or the removal of other entities from the approved subcontractors list.

While each contractor (prime, subcontractor, 2nd tier subcontractor) is responsible for accurate accounting of payments to DBEs, it shall be the prime contractor's responsibility to report all monthly and final payment information in the correct reporting manner.

Failure on the part of the Contractor to submit the required information in the time frame specified may result in the disqualification of that contractor and any affiliate companies from further bidding until the required information is submitted.

Failure on the part of any subcontractor to submit the required information in the time frame specified may result in the disqualification of that contractor and any affiliate companies from being approved for work on future DOT projects until the required information is submitted.

Contractors reporting transportation services provided by non-DBE lessees shall evaluate the value of services provided during the month of the reporting period only.

At any time, the Engineer can request written verification of subcontractor payments.

(A) Electronic Bids Reporting

The Contractor shall report the accounting of payments through the Department's DBE Payment Tracking System.

(B) Paper Bids Reporting

The Contractor shall report the accounting of payments on the Department's DBE-IS (*Subcontractor Payment Information*) with each invoice. Invoices will not be processed for payment until the DBE-IS is received.

**Failure to Meet Contract Requirements**

Failure to meet contract requirements in accordance with Subarticle 102-15(J) of the *2012 Standard Specifications* may be cause to disqualify the Contractor.

**CERTIFICATION FOR FEDERAL-AID CONTRACTS:**

(3-21-90)

SP1 G85

The prospective participant certifies, by signing and submitting this bid or proposal, to the best of his or her knowledge and belief, that:

- (A) No Federal appropriated funds have been paid or will be paid, by or on behalf of the undersigned, to any person for influencing or attempting to influence an officer or employee of any Federal agency, a Member of Congress, an officer or employee of Congress, or an employee of a Member of Congress in connection with the awarding of any Federal contract, the making of any Federal grant, the making of any Federal loan, the entering into of any cooperative agreement, and the extension, continuation, renewal, amendment, or modification of any Federal contract, grant, loan, or cooperative agreement.
- (B) If any funds other than Federal appropriated funds have been paid or will be paid to any person for influencing or attempting to influence an officer or employee of any Federal agency, a Member of Congress, an officer or employee of Congress, or an employee of

a Member of Congress in connection with this Federal contract, grant, loan, or cooperative agreement, the undersigned shall complete and submit Standard Form-LLL, *Disclosure Form to Report Lobbying*, in accordance with its instructions.

This certification is a material representation of fact upon which reliance was placed when this transaction was made or entered into. Submission of this certification is a prerequisite for making or entering into this transaction imposed by *Section 1352, Title 31, U.S. Code*. Any person who fails to file the required certification shall be subject to a civil penalty of not less than \$10,000 and not more than \$100,000 for each such failure.

The prospective participant also agrees by submitting his or her bid or proposal that he or she shall require that the language of this certification be included in all lower tier subcontracts, which exceed \$100,000 and that all such subrecipients shall certify and disclose accordingly.

**CONTRACTOR'S LICENSE REQUIREMENTS:**

(7-1-95)

102-14

SP1 G88

If the successful bidder does not hold the proper license to perform any plumbing, heating, air conditioning, or electrical work in this contract, he will be required to sublet such work to a contractor properly licensed in accordance with *Article 2 of Chapter 87 of the General Statutes* (licensing of heating, plumbing, and air conditioning contractors) and *Article 4 of Chapter 87 of the General Statutes* (licensing of electrical contractors).

**U.S. DEPARTMENT OF TRANSPORTATION HOTLINE:**

(11-22-94)

108-5

SP1 G100

To report bid rigging activities call: **1-800-424-9071**

The U.S. Department of Transportation (DOT) operates the above toll-free hotline Monday through Friday, 8:00 a.m. to 5:00 p.m. eastern time. Anyone with knowledge of possible bid rigging, bidder collusion, or other fraudulent activities should use the hotline to report such activities.

The hotline is part of the DOT's continuing effort to identify and investigate highway construction contract fraud and abuse is operated under the direction of the DOT Inspector General. All information will be treated confidentially and caller anonymity will be respected.

**SUBSURFACE INFORMATION:**

(7-1-95)

450

SP1 G112 A

There is **no** subsurface information available on this project. The Contractor shall make his own investigation of subsurface conditions.

**LOCATING EXISTING UNDERGROUND UTILITIES:**

(3-20-12)

105

SP1 G115

Revise the *2012 Standard Specifications* as follows:

**Page 1-43, Article 105-8, line 28, after the first sentence,** add the following:

Identify excavation locations by means of pre-marking with white paint, flags, or stakes or provide a specific written description of the location in the locate request.

**VALUE ENGINEERING PROPOSAL:**

(05-19-15)

104

SP01 G116

Revise the *2012 Standard Specifications* as follows:

**Page 1-36, Subarticle 104-12(B) Evaluation of Proposals, lines 42-44,** replace the fourth sentence of the second paragraph with the following:

Pending execution of a formal supplemental agreement implementing an approved VEP and transferal of final plans (hard copy and electronic) sealed by an engineer licensed in the State of North Carolina incorporating an approved VEP to the Resident Engineer and the State Value Management Engineer, the Contractor shall remain obligated to perform the work in accordance with the terms of the existing contract.

**Page 1-37, Subarticle 104-12(D) Preliminary Review, lines 9-12,** replace the first sentence of the first paragraph with the following:

Should the Contractor desire a preliminary review of a possible VEP, before expending considerable time and expense in full development, a copy of the Preliminary VEP shall be submitted to the Resident Engineer and the State Value Management Engineer at ValueManagementUnit@ncdot.gov.

**Page 1-37, Subarticle 104-12(E) Final Proposal, lines 22-23,** replace the first sentence of the first paragraph with the following:

A copy of the Final VEP shall be submitted by the Contractor to the Resident Engineer and the State Value Management Engineer at ValueManagementUnit@ncdot.gov.

**Page 1-38, Subarticle 104-12(F) Modifications, lines 2-8,** replace the first paragraph with the following:

To facilitate the preparation of revisions to contract drawings, the Contractor may purchase reproducible copies of drawings for his use through the Department's Value Management Unit. The preparation of new design drawings by or for the Contractor shall be coordinated with the appropriate Design Branch through the State Value Management Engineer. The Contractor shall provide, at no charge to the Department, one set of reproducible drawings of the approved design needed to implement the VEP. Drawings (hard copy and electronic) which are sealed by an

engineer licensed in the State of North Carolina shall be submitted to the State Value Management Engineer no later than ten (10) business days after acceptance of a VEP unless otherwise permitted.

**Page 1-38, Subarticle 104-12(F) Modifications, line 17,** add the following at the end of the third paragraph:

Supplemental agreements executed for design-bid-build contracts shall reflect any realized savings in the corresponding line items. Supplemental agreements executed for design-build contracts shall add one line item deducting the full savings from the total contract price and one line item crediting the Contractor with 50% of the total VEP savings.

**Page 1-38, Subarticle 104-12(F) Modifications, lines 45-47,** replace the eighth paragraph with the following:

Unless and until a supplemental agreement is executed and issued by the Department and final plans (hard copy and electronic) sealed by an engineer licensed in the State of North Carolina incorporating an approved VEP have been provided to the Resident Engineer and the State Value Management Engineer, the Contractor shall remain obligated to perform the work in accordance with the terms of the existing contract.

**RESOURCE CONSERVATION AND ENV. SUSTAINABLE PRACTICES:**

(5-21-13) (Rev. 5-19-15)

104-13

SP1 G118

In accordance with North Carolina Executive Order 156, NCGS 130A-309.14(3), and NCGS 136-28.8, it is the objective of the Department to aid in the reduction of materials that become a part of our solid waste stream, to divert materials from landfills, to find ways to recycle and reuse materials, to consider and minimize, where economically feasible, the environmental impacts associated with agency land use and acquisition, construction, maintenance and facility management for the benefit of the Citizens of North Carolina.

To achieve the mission of reducing environmental impacts across the state, the Department is committed to supporting the efforts to initiate, develop and use products and construction methods that incorporate the use of recycled, solid waste products and environmentally sustainable practices in accordance with Article 104-13 of the *Standard Specifications*.

Report the quantities of reused or recycled materials either incorporated in the project or diverted from landfills and any practice that minimizes the environmental impact on the project annually on the Project Construction Reuse and Recycling Reporting Form. The Project Construction Reuse and Recycling Reporting Form and a location tool for local recycling facilities are available at:

<http://connect.ncdot.gov/resources/Environmental/Pages/North-Carolina-Recycling-Locations.aspx>.

Submit the Project Construction Reuse and Recycling Reporting Form by August 1 annually to [valuemanagementunit@ncdot.gov](mailto:valuemanagementunit@ncdot.gov). For questions regarding the form or reporting, please contact the State Value Management Engineer at 919-707-4810.

**DOMESTIC STEEL:**

(4-16-13)

106

SP1 G120

Revise the *2012 Standard Specifications* as follows:

**Page 1-49, Subarticle 106-1(B) Domestic Steel, lines 2-7,** replace the first paragraph with the following:

All steel and iron products that are permanently incorporated into this project shall be produced in the United States except minimal amounts of foreign steel and iron products may be used provided the combined material cost of the items involved does not exceed 0.1% of the total amount bid for the entire project or \$2,500, whichever is greater. If invoices showing the cost of the material are not provided, the amount of the bid item involving the foreign material will be used for calculations. This minimal amount of foreign produced steel and iron products permitted for use is not applicable to high strength fasteners. Domestically produced high strength fasteners are required.

**MAINTENANCE OF THE PROJECT:**

(11-20-07) (Rev. 1-17-12)

104-10

SP1 G125

Revise the *2012 Standard Specifications* as follows:

**Page 1-35, Article 104-10 Maintenance of the Project, line 25,** add the following after the first sentence of the first paragraph:

All guardrail/guiderail within the project limits shall be included in this maintenance.

**Page 1-35, Article 104-10 Maintenance of the Project, line 30,** add the following as the last sentence of the first paragraph:

The Contractor shall perform weekly inspections of guardrail and guiderail and shall report damages to the Engineer on the same day of the weekly inspection. *Where damaged guardrail or guiderail is repaired or replaced as a result of maintaining the project in accordance with this article, such repair or replacement shall be performed within 7 consecutive calendar days of such inspection report.*

**Page 1-35, Article 104-10 Maintenance of the Project, lines 42-44,** replace the last sentence of the last paragraph with the following:

The Contractor will not be directly compensated for any maintenance operations necessary, except for maintenance of guardrail/guiderail, as this work will be considered incidental to the work covered by the various contract items. The provisions of Article 104-7, Extra Work, and Article 104-8, Compensation and Record Keeping will apply to authorized maintenance of guardrail/guiderail. Performance of weekly inspections of guardrail/guiderail, and the damage reports required as described above, will be considered to be an incidental part of the work being paid for by the various contract items.



**TWELVE MONTH GUARANTEE:**

(7-15-03)

108

SPI G145

- (A) The Contractor shall guarantee materials and workmanship against latent and patent defects arising from faulty materials, faulty workmanship or negligence for a period of twelve months following the date of final acceptance of the work for maintenance and shall replace such defective materials and workmanship without cost to the Department. The Contractor will not be responsible for damage due to faulty design, normal wear and tear, for negligence on the part of the Department, and/or for use in excess of the design.
- (B) Where items of equipment or material carry a manufacturer's guarantee for any period in excess of twelve months, then the manufacturer's guarantee shall apply for that particular piece of equipment or material. The Department's first remedy shall be through the manufacturer although the Contractor is responsible for invoking the warranted repair work with the manufacturer. The Contractor's responsibility shall be limited to the term of the manufacturer's guarantee. NCDOT would be afforded the same warranty as provided by the Manufacturer.

This guarantee provision shall be invoked only for major components of work in which the Contractor would be wholly responsible for under the terms of the contract. Examples would include pavement structures, bridge components, and sign structures. This provision will not be used as a mechanism to force the Contractor to return to the project to make repairs or perform additional work that the Department would normally compensate the Contractor for. In addition, routine maintenance activities (i.e. mowing grass, debris removal, ruts in earth shoulders,) are not parts of this guarantee.

Appropriate provisions of the payment and/or performance bonds shall cover this guarantee for the project.

To ensure uniform application statewide the Division Engineer will forward details regarding the circumstances surrounding any proposed guarantee repairs to the Chief Engineer for review and approval prior to the work being performed.

**GIFTS FROM VENDORS AND CONTRACTORS:**

(12-15-09)

107-1

SPI G152

By Executive Order 24, issued by Governor Perdue, and *N.C.G.S. § 133-32*, it is unlawful for any vendor or contractor (i.e. architect, bidder, contractor, construction manager, design professional, engineer, landlord, offeror, seller, subcontractor, supplier, or vendor), to make gifts or to give favors to any State employee of the Governor's Cabinet Agencies (i.e. Administration, Commerce, Correction, Crime Control and Public Safety, Cultural Resources, Environment and Natural Resources, Health and Human Services, Juvenile Justice and Delinquency Prevention, Revenue, Transportation, and the Office of the Governor). This prohibition covers those vendors and contractors who:

- (A) Have a contract with a governmental agency; or  
(B) Have performed under such a contract within the past year; or  
(C) Anticipate bidding on such a contract in the future.

For additional information regarding the specific requirements and exemptions, vendors and contractors are encouraged to review Executive Order 24 and *N.C.G.S. § 133-32*.

Executive Order 24 also encouraged and invited other State Agencies to implement the requirements and prohibitions of the Executive Order to their agencies. Vendors and contractors should contact other State Agencies to determine if those agencies have adopted Executive Order 24.

**LIABILITY INSURANCE:**

(5-20-14)

SP1 G160

Revise the *2012 Standard Specifications* as follows:

**Page 1-60, Article 107-15 LIABILITY INSURANCE, line 16**, add the following as the second sentence of the third paragraph:

Prior to beginning services, all contractors shall provide proof of coverage issued by a workers' compensation insurance carrier, or a certificate of compliance issued by the Department of Insurance for self-insured subcontractors, irrespective of whether having regularly in service fewer than three employees.

**EROSION AND SEDIMENT CONTROL/STORMWATER CERTIFICATION:**

(1-16-07) (Rev 9-18-12)

105-16, 225-2, 16

SP1 G180

**General**

Schedule and conduct construction activities in a manner that will minimize soil erosion and the resulting sedimentation and turbidity of surface waters. Comply with the requirements herein regardless of whether or not a National Pollution discharge Elimination System (NPDES) permit for the work is required.

Establish a chain of responsibility for operations and subcontractors' operations to ensure that the *Erosion and Sediment Control/Stormwater Pollution Prevention Plan* is implemented and maintained over the life of the contract.

- (A) *Certified Supervisor* - Provide a certified Erosion and Sediment Control/Stormwater Supervisor to manage the Contractor and subcontractor operations, insure compliance with Federal, State and Local ordinances and regulations, and manage the Quality Control Program.
- (B) *Certified Foreman* - Provide a certified, trained foreman for each construction operation that increases the potential for soil erosion or the possible sedimentation and turbidity of surface waters.
- (C) *Certified Installer* - Provide a certified installer to install or direct the installation for erosion or sediment/stormwater control practices.

- (D) *Certified Designer* - Provide a certified designer for the design of the erosion and sediment control/stormwater component of reclamation plans and, if applicable, for the design of the project erosion and sediment control/stormwater plan.

### **Roles and Responsibilities**

- (A) *Certified Erosion and Sediment Control/Stormwater Supervisor* - The Certified Supervisor shall be Level II and responsible for ensuring the erosion and sediment control/stormwater plan is adequately implemented and maintained on the project and for conducting the quality control program. The Certified Supervisor shall be on the project within 24 hours notice from initial exposure of an erodible surface to the project's final acceptance. Perform the following duties:
- (1) **Manage Operations** - Coordinate and schedule the work of subcontractors so that erosion and sediment control/stormwater measures are fully executed for each operation and in a timely manner over the duration of the contract.
    - (a) Oversee the work of subcontractors so that appropriate erosion and sediment control/stormwater preventive measures are conformed to at each stage of the work.
    - (b) Prepare the required National Pollutant Discharge Elimination System (NPDES) Inspection Record and submit to the Engineer.
    - (c) Attend all weekly or monthly construction meetings to discuss the findings of the NPDES inspection and other related issues.
    - (d) Implement the erosion and sediment control/stormwater site plans requested.
    - (e) Provide any needed erosion and sediment control/stormwater practices for the Contractor's temporary work not shown on the plans, such as, but not limited to work platforms, temporary construction, pumping operations, plant and storage yards, and cofferdams.
    - (f) Acquire applicable permits and comply with requirements for borrow pits, dewatering, and any temporary work conducted by the Contractor in jurisdictional areas.
    - (g) Conduct all erosion and sediment control/stormwater work in a timely and workmanlike manner.
    - (h) Fully perform and install erosion and sediment control/stormwater work prior to any suspension of the work.
    - (i) Coordinate with Department, Federal, State and Local Regulatory agencies on resolution of erosion and sediment control/stormwater issues due to the Contractor's operations.
    - (j) Ensure that proper cleanup occurs from vehicle tracking on paved surfaces or any location where sediment leaves the Right-of-Way.
    - (k) Have available a set of erosion and sediment control/stormwater plans that are initialed and include the installation date of Best Management Practices. These practices shall include temporary and permanent groundcover and be properly updated to reflect necessary plan and field

changes for use and review by Department personnel as well as regulatory agencies.

- (2) Requirements set forth under the NPDES Permit - The Department's NPDES Stormwater permit (NCS000250) outlines certain objectives and management measures pertaining to construction activities. The permit references *NCG010000, General Permit to Discharge Stormwater* under the NPDES, and states that the Department shall incorporate the applicable requirements into its delegated Erosion and Sediment Control Program for construction activities disturbing one or more acres of land. The Department further incorporates these requirements on all contracted bridge and culvert work at jurisdictional waters, regardless of size. Some of the requirements are, but are not limited to:
  - (a) Control project site waste to prevent contamination of surface or ground waters of the state, i.e. from equipment operation/maintenance, construction materials, concrete washout, chemicals, litter, fuels, lubricants, coolants, hydraulic fluids, any other petroleum products, and sanitary waste.
  - (b) Inspect erosion and sediment control/stormwater devices and stormwater discharge outfalls at least once every 7 calendar days, twice weekly for construction related *Federal Clean Water Act, Section 303(d)* impaired streams with turbidity violations, and within 24 hours after a significant rainfall event of 0.5 inch that occurs within a 24 hour period.
  - (c) Maintain an onsite rain gauge or use the Department's Multi-Sensor Precipitation Estimate website to maintain a daily record of rainfall amounts and dates.
  - (d) Maintain erosion and sediment control/stormwater inspection records for review by Department and Regulatory personnel upon request.
  - (e) Implement approved reclamation plans on all borrow pits, waste sites and staging areas.
  - (f) Maintain a log of turbidity test results as outlined in the Department's Procedure for Monitoring Borrow Pit Discharge.
  - (g) Provide secondary containment for bulk storage of liquid materials.
  - (h) Provide training for employees concerning general erosion and sediment control/stormwater awareness, the Department's NPDES Stormwater Permit NCS000250 requirements, and the applicable requirements of the *General Permit, NCG010000*.
  - (i) Report violations of the NPDES permit to the Engineer immediately who will notify the Division of Water Quality Regional Office within 24 hours of becoming aware of the violation.
- (3) Quality Control Program - Maintain a quality control program to control erosion, prevent sedimentation and follow provisions/conditions of permits. The quality control program shall:

- (a) Follow permit requirements related to the Contractor and subcontractors' construction activities.
  - (b) Ensure that all operators and subcontractors on site have the proper erosion and sediment control/stormwater certification.
  - (c) Notify the Engineer when the required certified erosion and sediment control/stormwater personnel are not available on the job site when needed.
  - (d) Conduct the inspections required by the NPDES permit.
  - (e) Take corrective actions in the proper timeframe as required by the NPDES permit for problem areas identified during the NPDES inspections.
  - (f) Incorporate erosion control into the work in a timely manner and stabilize disturbed areas with mulch/seed or vegetative cover on a section-by-section basis.
  - (g) Use flocculants approved by state regulatory authorities where appropriate and where required for turbidity and sedimentation reduction.
  - (h) Ensure proper installation and maintenance of temporary erosion and sediment control devices.
  - (i) Remove temporary erosion or sediment control devices when they are no longer necessary as agreed upon by the Engineer.
  - (j) The Contractor's quality control and inspection procedures shall be subject to review by the Engineer. Maintain NPDES inspection records and make records available at all times for verification by the Engineer.
- (B) *Certified Foreman* - At least one Certified Foreman shall be onsite for each type of work listed herein during the respective construction activities to control erosion, prevent sedimentation and follow permit provisions:
- (1) Foreman in charge of grading activities
  - (2) Foreman in charge of bridge or culvert construction over jurisdictional areas
  - (3) Foreman in charge of utility activities
- The Contractor may request to use the same person as the Level II Supervisor and Level II Foreman. This person shall be onsite whenever construction activities as described above are taking place. This request shall be approved by the Engineer prior to work beginning.
- The Contractor may request to name a single Level II Foreman to oversee multiple construction activities on small bridge or culvert replacement projects. This request shall be approved by the Engineer prior to work beginning.
- (C) *Certified Installers* - Provide at least one onsite, Level I Certified Installer for each of the following erosion and sediment control/stormwater crew:
- (1) Seeding and Mulching
  - (2) Temporary Seeding
  - (3) Temporary Mulching

- (4) Sodding
- (5) Silt fence or other perimeter erosion/sediment control device installations
- (6) Erosion control blanket installation
- (7) Hydraulic tackifier installation
- (8) Turbidity curtain installation
- (9) Rock ditch check/sediment dam installation
- (10) Ditch liner/matting installation
- (11) Inlet protection
- (12) Riprap placement
- (13) Stormwater BMP installations (such as but not limited to level spreaders, retention/detention devices)
- (14) Pipe installations within jurisdictional areas

If a Level I *Certified Installer* is not onsite, the Contractor may substitute a Level II Foreman for a Level I Installer, provided the Level II Foreman is not tasked to another crew requiring Level II Foreman oversight.

- (D) *Certified Designer* - Include the certification number of the Level III Certified Designer on the erosion and sediment control/stormwater component of all reclamation plans and if applicable, the certification number of the Level III Certified Designer on the design of the project erosion and sediment control/stormwater plan.

### **Preconstruction Meeting**

Furnish the names of the *Certified Erosion and Sediment Control/Stormwater Supervisor*, *Certified Foremen*, *Certified Installers* and *Certified Designer* and notify the Engineer of changes in certified personnel over the life of the contract within 2 days of change.

### **Ethical Responsibility**

Any company performing work for the North Carolina Department of Transportation has the ethical responsibility to fully disclose any reprimand or dismissal of an employee resulting from improper testing or falsification of records.

### **Revocation or Suspension of Certification**

Upon recommendation of the Chief Engineer to the certification entity, certification for *Supervisor*, *Certified Foremen*, *Certified Installers* and *Certified Designer* may be revoked or suspended with the issuance of an *Immediate Corrective Action (ICA)*, *Notice of Violation (NOV)*, or *Cease and Desist Order* for erosion and sediment control/stormwater related issues.

The Chief Engineer may recommend suspension or permanent revocation of certification due to the following:

- (A) Failure to adequately perform the duties as defined within this certification provision.

- (B) Issuance of an ICA, NOV, or Cease and Desist Order.
- (C) Failure to fully perform environmental commitments as detailed within the permit conditions and specifications.
- (D) Demonstration of erroneous documentation or reporting techniques.
- (E) Cheating or copying another candidate's work on an examination.
- (F) Intentional falsification of records.
- (G) Directing a subordinate under direct or indirect supervision to perform any of the above actions.
- (H) Dismissal from a company for any of the above reasons.
- (I) Suspension or revocation of one's certification by another entity.

Suspension or revocation of a certification will be sent by certified mail to the certificant and the Corporate Head of the company that employs the certificant.

A certificant has the right to appeal any adverse action which results in suspension or permanent revocation of certification by responding, in writing, to the Chief Engineer within 10 calendar days after receiving notice of the proposed adverse action.

Chief Engineer  
1536 Mail Service Center  
Raleigh, NC 27699-1536

Failure to appeal within 10 calendar days will result in the proposed adverse action becoming effective on the date specified on the certified notice. Failure to appeal within the time specified will result in a waiver of all future appeal rights regarding the adverse action taken. The certificant will not be allowed to perform duties associated with the certification during the appeal process.

The Chief Engineer will hear the appeal and make a decision within 7 days of hearing the appeal. Decision of the Chief Engineer will be final and will be made in writing to the certificant.

If a certification is temporarily suspended, the certificant shall pass any applicable written examination and any proficiency examination, at the conclusion of the specified suspension period, prior to having the certification reinstated.

### **Measurement and Payment**

*Certified Erosion and Sediment Control/Stormwater Supervisor, Certified Foremen, Certified Installers and Certified Designer* will be incidental to the project for which no direct compensation will be made.

### **PROCEDURE FOR MONITORING BORROW PIT DISCHARGE:**

(2-20-07) (Rev. 3-19-13)

105-16, 230, 801

SP1 G181

Water discharge from borrow pit sites shall not cause surface waters to exceed 50 NTUs (nephelometric turbidity unit) in streams not designated as trout waters and 10 NTUs in streams, lakes or reservoirs designated as trout waters. For lakes and reservoirs not designated as trout

waters, the turbidity shall not exceed 25 NTUs. If the turbidity exceeds these levels due to natural background conditions, the existing turbidity level shall not be increased.

If during any operating day, the downstream water quality exceeds the standard, the Contractor shall do all of the following:

- (A) Either cease discharge or modify the discharge volume or turbidity levels to bring the downstream turbidity levels into compliance, or
- (B) Evaluate the upstream conditions to determine if the exceedance of the standard is due to natural background conditions. If the background turbidity measurements exceed the standard, operation of the pit and discharge can continue as long as the stream turbidity levels are not increased due to the discharge.
- (C) Measure and record the turbidity test results (time, date and sampler) at all defined sampling locations 30 minutes after startup and at a minimum, one additional sampling of all sampling locations during that 24-hour period in which the borrow pit is discharging.
- (D) Notify DWQ within 24 hours of any stream turbidity standard exceedances that are not brought into compliance.

During the Environmental Assessment required by Article 230-4 of the *2012 Standard Specifications*, the Contractor shall define the point at which the discharge enters into the State's surface waters and the appropriate sampling locations. Sampling locations shall include points upstream and downstream from the point at which the discharge enters these waters. Upstream sampling location shall be located so that it is not influenced by backwater conditions and represents natural background conditions. Downstream sampling location shall be located at the point where complete mixing of the discharge and receiving water has occurred.

The discharge shall be closely monitored when water from the dewatering activities is introduced into jurisdictional wetlands. Any time visible sedimentation (deposition of sediment) on the wetland surface is observed, the dewatering activity will be suspended until turbidity levels in the stilling basin can be reduced to a level where sediment deposition does not occur. Staining of wetland surfaces from suspended clay particles, occurring after evaporation or infiltration, does not constitute sedimentation. No activities shall occur in wetlands that adversely affect the functioning of a wetland. Visible sedimentation will be considered an indication of possible adverse impacts on wetland use.

The Engineer will perform independent turbidity tests on a random basis. These results will be maintained in a log within the project records. Records will include, at a minimum, turbidity test results, time, date and name of sampler. Should the Department's test results exceed those of the Contractor's test results, an immediate test shall be performed jointly with the results superseding the previous test results of both the Department and the Contractor.

The Contractor shall use the *NCDOT Turbidity Reduction Options for Borrow Pits Matrix*, available at [http://www.ncdot.gov/doh/operations/dp\\_chief\\_eng/roadside/fieldops/downloads/](http://www.ncdot.gov/doh/operations/dp_chief_eng/roadside/fieldops/downloads/)



[Files/TurbidityReductionOptionSheet.pdf](#) to plan, design, construct, and maintain BMPs to address water quality standards. Tier I Methods include stilling basins which are standard compensatory BMPs. Other Tier I methods are noncompensatory and shall be used when needed to meet the stream turbidity standards. Tier II Methods are also noncompensatory and are options that may be needed for protection of rare or unique resources or where special environmental conditions exist at the site which have led to additional requirements being placed in the DWQ's 401 Certifications and approval letters, Isolated Wetland Permits, Riparian Buffer Authorization or a DOT Reclamation Plan's Environmental Assessment for the specific site. Should the Contractor exhaust all Tier I Methods on a site exclusive of rare or unique resources or special environmental conditions, Tier II Methods may be required by regulators on a case by case basis per supplemental agreement.

The Contractor may use cation exchange capacity (CEC) values from proposed site borings to plan and develop the bid for the project. CEC values exceeding 15 milliequivalents per 100 grams of soil may indicate a high potential for turbidity and should be avoided when dewatering into surface water is proposed.

No additional compensation for monitoring borrow pit discharge will be paid.

**EMPLOYMENT:**

(11-15-11) (Rev. 1-17-12)

108, 102

SP1 G184

Revise the *2012 Standard Specifications* as follows:

**Page 1-20, Subarticle 102-15(O)**, delete and replace with the following:

(O) Failure to restrict a former Department employee as prohibited by Article 108-5.

**Page 1-65, Article 108-5 Character of Workmen, Methods, and Equipment, line 32**, delete all of line 32, the first sentence of the second paragraph and the first word of the second sentence of the second paragraph.

**STATE HIGHWAY ADMINISTRATOR TITLE CHANGE:**

(9-18-12)

SP1 G185

Revise the *2012 Standard Specifications* as follows:

Replace all references to "State Highway Administrator" with "Chief Engineer".

**SUBLETTING OF CONTRACT:**

(11-18-2014)

108-6

SPI G186

Revise the *2012 Standard Specifications* as follows:

**Page 1-66, Article 108-6 Subletting of Contract, line 37**, add the following as the second sentence of the first paragraph:

All requests to sublet work shall be submitted within 30 days of the date of availability or prior to expiration of 20% of the contract time, whichever date is later, unless otherwise approved by the Engineer.

**Page 1-67, Article 108-6 Subletting of Contract, line 7**, add the following as the second sentence of the fourth paragraph:

Purchasing materials for subcontractors is not included in the percentage of work required to be performed by the Contractor. If the Contractor sublets items of work but elects to purchase material for the subcontractor, the value of the material purchased will be included in the total dollar amount considered to have been sublet.

**PROJECT SPECIAL PROVISIONS****ROADWAY****CLEARING AND GRUBBING - METHOD II:**

(9-17-02) (Rev.8-18-15)

200

SP2 R02A

Perform clearing on this project to the limits established by Method "II" shown on Standard Drawing No. 200.02 of the *2012 Roadway Standard Drawings*. Conventional clearing methods may be used except where permit drawings or conditions have been included in the proposal which require certain areas to be cleared by hand methods.

**BURNING RESTRICTIONS:**

(7-1-95)

200, 210, 215

SP2 R05

Open burning is not permitted on any portion of the right-of-way limits established for this project. Do not burn the clearing, grubbing or demolition debris designated for disposal and generated from the project at locations within the project limits, off the project limits or at any waste or borrow sites in this county. Dispose of the clearing, grubbing and demolition debris by means other than burning, according to state or local rules and regulations.

**SHOULDER AND FILL SLOPE MATERIAL:**

(5-21-02)

235, 560

SP2 R45 A

**Description**

Perform the required shoulder and slope construction for this project in accordance with the applicable requirements of Section 560 and Section 235 of the *2012 Standard Specifications*.

**Measurement and Payment**

Where the material has been obtained from an authorized stockpile or from a borrow source and *Borrow Excavation* is not included in the contract, no direct payment will be made for this work, as the cost of this work will be part of the work being paid at the contract lump sum price for *Grading*. If *Borrow Excavation* is included in this contract and the material has been obtained from an authorized stockpile or from a borrow source, measurement and payment will be as provided in Section 230 of the *2012 Standard Specifications* for *Borrow Excavation*.

**PIPE INSTALLATION:**

(11-20-12) (Rev. 8-18-15)

300

SP3 R01

Revise the *2012 Standard Specifications* as follows:

**Page 3-1, Article 300-2, Materials**, line 15, in the materials table, replace “Flowable Fill” and “Geotextiles” with the following:

<b>Item</b>	<b>Section</b>
Flowable Fill, Excavatable	1000-6
Grout, Type 2	1003
Geotextiles, Type 4	1056

**Page 3-1, Article 300-2, Materials**, lines 23-24, replace sentence with the following:

Provide foundation conditioning geotextile and geotextile to wrap pipe joints in accordance with Section 1056 for Type 4 geotextile.

**Page 3-3, Subarticle 300-6(A), Rigid Pipe**, line 2, in the first paragraph, replace “an approved non-shrink grout.” with “grout.” and line 4, in the second paragraph, replace “filtration geotextile” with “geotextile”.

**Page 3-3, Article 300-7, Backfilling**, lines 37-38, in the first and second sentences of the fifth paragraph, replace “Excavatable flowable fill” with “Flowable fill”.

**FLOWABLE FILL:**

(9-17-02) (Rev 1-17-12)

300, 340, 450, 1000, 1530, 1540, 1550

SP3 R30

**Description**

This work consists of all work necessary to place flowable fill in accordance with these provisions, the plans, and as directed.

**Materials**

Refer to Division 10 of the *2012 Standard Specifications*.

<b>Item</b>	<b>Section</b>
Flowable Fill	1000-6

**Construction Methods**

Discharge flowable fill material directly from the truck into the space to be filled, or by other approved methods. The mix may be placed full depth or in lifts as site conditions dictate. The Contractor shall provide a method to plug the ends of the existing pipe in order to contain the flowable fill.

### Measurement and Payment

At locations where flowable fill is called for on the plans and a pay item for flowable fill is included in the contract, *Flowable Fill* will be measured in cubic yards and paid as the actual number of cubic yards that have been satisfactorily placed and accepted. Such price and payment will be full compensation for all work covered by this provision including, but not limited to, the mix design, furnishing, hauling, placing and containing the flowable fill.

Payment will be made under:

Pay Item	Pay Unit
Flowable Fill	Cubic Yard

### ASPHALT PAVEMENTS - SUPERPAVE:

(6-19-12) (Rev. 1-19-16)

605, 609, 610, 650

SP6 R01

Revise the *2012 Standard Specifications* as follows:

**Page 6-3, Article 605-7, APPLICATION RATES AND TEMPERATURES**, replace this article, including Table 605-1, with the following:

Apply tack coat uniformly across the existing surface at target application rates shown in Table 605-1.

<b>TABLE 605-1 APPLICATION RATES FOR TACK COAT</b>	
Existing Surface	Target Rate (gal/sy)
	Emulsified Asphalt
New Asphalt	0.04 ± 0.01
Oxidized or Milled Asphalt	0.06 ± 0.01
Concrete	0.08 ± 0.01

Apply tack coat at a temperature within the ranges shown in Table 605-2. Tack coat shall not be overheated during storage, transport or at application.

<b>TABLE 605-2 APPLICATION TEMPERATURE FOR TACK COAT</b>	
Asphalt Material	Temperature Range
Asphalt Binder, Grade PG 64-22	350 - 400°F
Emulsified Asphalt, Grade RS-1H	130 - 160°F
Emulsified Asphalt, Grade CRS-1	130 - 160°F
Emulsified Asphalt, Grade CRS-1H	130 - 160°F
Emulsified Asphalt, Grade HFMS-1	130 - 160°F
Emulsified Asphalt, Grade CRS-2	130 - 160°F

**Page 6-7, Article 609-3, FIELD VERIFICATION OF MIXTURE AND JOB MIX FORMULA ADJUSTMENTS**, lines 35-37, delete the second sentence of the second paragraph.

**Page 6-18, Article 610-1 DESCRIPTION**, lines 40-41, delete the last sentence of the last paragraph.

**Page 6-19, Subarticle 610-3(A), Mix Design-General**, line 5, add the following as the first paragraph:

Warm mix asphalt (WMA) is allowed for use at the Contractor's option in accordance with the NCDOT Approved Products List for WMA Technologies available at:

**<https://connect.ncdot.gov/resources/Materials/MaterialsResources/Warm%20Mix%20Asphalt%20Approved%20List.pdf>**

**Page 6-20, Subarticle 610-3(C), Job Mix Formula (JMF)**, lines 47-48, replace the last sentence of the third paragraph with the following:

The JMF mix temperature shall be within the ranges shown in Table 610-1 unless otherwise approved.

**Page 6-21, Subarticle 610-3(C) Job Mix Formula (JMF)**, replace Table 610-1 with the following:

<b>TABLE 610-1 MIXING TEMPERATURE AT THE ASPHALT PLANT</b>	
<b>Binder Grade</b>	<b>JMF Mix Temperature</b>
PG 58-28; PG 64-22	250 - 290°F
PG 70-22	275- 305°F
PG 76-22	300- 325°F

**Page 6-21, Subarticle 610-3(C) Job Mix Formula (JMF)**, lines 1-2, in the first sentence of the first paragraph, delete "and compaction". Lines 4-7, delete the second paragraph and replace with the following:

When RAS is used, the JMF mix temperature shall be established at 275°F or higher.

**Page 6-22, Article 610-4, WEATHER, TEMPERATURE AND SEASONAL LIMITATIONS FOR PRODUCING AND PLACING ASPHALT MIXTURES**, lines 15-17, replace the second sentence of the first paragraph with the following:

Do not place asphalt material when the air or surface temperatures, measured at the location of the paving operation away from artificial heat, do not meet Table 610-5.

**Page 6-23, Article 610-4, WEATHER, TEMPERATURE AND SEASONAL LIMITATIONS FOR PRODUCING AND PLACING ASPHALT MIXTURES**, replace Table 610-5 with the following:

<b>TABLE 610-5 PLACEMENT TEMPERATURES FOR ASPHALT</b>	
<b>Asphalt Concrete Mix Type</b>	<b>Minimum Surface and Air Temperature</b>
B25.0B, C	35°F
I19.0B, C, D	35°F
SF9.5A, S9.5B	40°F <sup>A</sup>
S9.5C, S12.5C	45°F <sup>A</sup>
S9.5D, S12.5D	50°F

**A.** For the final layer of surface mixes containing recycled asphalt shingles (RAS), the minimum surface and air temperature shall be 50°F.

**Page 6-23, Subarticle 610-5(A), General,** lines 33-34, replace the last sentence of the third paragraph with the following:

Produce the mixture at the asphalt plant within  $\pm 25$  °F of the JMF mix temperature. The temperature of the mixture, when discharged from the mixer, shall not exceed 350°F.

**Page 6-26, Article 610-7, HAULING OF ASPHALT MIXTURE,** lines 22-23, in the fourth sentence of the first paragraph replace “so as to overlap the top of the truck bed and” with “to”. Line 28, in the last paragraph, replace “+15 °F to -25 °F of the specified JMF temperature.” with “ $\pm 25$  °F of the specified JMF mix temperature.”

**Page 6-26, Article 610-8, SPREADING AND FINISHING, line 34,** add the following new paragraph:

As referenced in Section 9.6.3 of the *HMA/QMS Manual*, use the automatic screed controls on the paver to control the longitudinal profile. Where approved by the Engineer, the Contractor has the option to use either a fixed or mobile string line.

**Page 6-29, Article 610-13, FINAL SURFACE TESTING AND ACCEPTANCE, line 39,** add the following after the first sentence in the first paragraph:

Smoothness acceptance testing using the inertial profiler is not required on ramps and turn lanes that are less than 1000 feet and all loops.

**Page 6-30, Subarticle 610-13(A), Option 1 – Inertial Profiler, lines 15-16,** replace the fourth sentence of the fourth paragraph with the following:

The interval at which relative profile elevations are reported shall be 2”.

**Page 6-30, Subarticle 610-13(A), Option 1 – Inertial Profiler, lines 25-28,** replace the ninth paragraph with the following:

Operate the profiler at any speed as per the manufacturer’s recommendations to collect valid data.

**Page 6-30, Subarticle 610-13(A), Option 1 – Inertial Profiler, lines 30-31,** delete the third sentence of the tenth paragraph.

**Page 6-31, Subarticle 610-13(A), Option 1 – Inertial Profiler, lines 11-13,** replace the first sentence of the third paragraph with the following:

After testing, transfer the profile data from the profiler portable computer's hard drive to a write once storage media (Flash drive, USB, DVD-R or CD-R) or electronic media approved by the Engineer.

**Page 6-31, Subarticle 610-13(A), Option 1 – Inertial Profiler, lines 17-18,** replace the first sentence of the fourth paragraph with the following:

Submit a report with the documentation and electronic data of the evaluation for each section to the Engineer within 10 days after completion of the smoothness testing. The report shall be in the tabular format for each 0.10 segment or a portion thereof with a summary of the MRI values and the localized roughness areas including corresponding project station numbers or acceptable reference points. Calculate the pay adjustments for all segments in accordance with the formulas in Sections (1) and (2) shown below. The Engineer shall review and approval all pay adjustments unless corrective action is required.

**Page 6-31, Subarticle 610-13(A)(1), Acceptance for New Construction, lines 36-37,** replace the third paragraph with the following:

The price adjustment will apply to each 0.10-mile section or prorated for a portion thereof, based on the Mean Roughness Index (MRI), the average IRI values from both wheel paths.

**Page 6-32, Subarticle 610-13(A)(2), Localized Roughness, lines 12-16,** replace the first paragraph with the following:

Areas of localized roughness shall be identified through the "Smoothness Assurance Module (SAM)" provided in the ProVAL software. Use the SAM report to optimize repair strategies by analyzing the measurements from profiles collected using inertial profilers. The ride quality threshold for localized roughness shall be 165 in/mile for any sections that are 15 ft. to 100 ft. in length at the continuous short interval of 25 ft. Submit a continuous roughness report to identify each section with project station numbers or reference points outside the threshold and identify all localized roughness, with the signature of the Operator included with the submitted IRI trace and electronic files.

**Page 6-32, Subarticle 610-13(A)(2), Localized Roughness, line 21,** add the following new paragraph:

If the Engineer does not require corrective action, the pay adjustment for each area of localized roughness shall be based on the following formula:

$$PA = (165 - LR\#) 5$$



Where:

PA = Pay Adjustment (dollars)  
 LR# = The Localized Roughness number determined from SAM report for the ride quality threshold

**Page 6-41, Subarticle 650-3(B), Mix Design Criteria**, replace Table 650-1 with the following:

<b>TABLE 650-1 OGAFC GRADATION CRITERIA</b>			
<i>Sieve Size (mm)</i>	<i>Type FC-1</i>	<i>Type FC-1 Modified</i>	<i>Type FC-2 Modified</i>
19.0	-	-	100
12.5	100	100	80 - 100
9.50	75 - 100	75 - 100	55 - 80
4.75	25 - 45	25 - 45	15 - 30
2.36	5 - 15	5 - 15	5 - 15
0.075	1.0 - 3.0	1.0 - 3.0	2.0 - 4.0

**ASPHALT BINDER CONTENT OF ASPHALT PLANT MIXES:**

(11-21-00) (Rev. 7-17-12)

609

SP6 R15

The approximate asphalt binder content of the asphalt concrete plant mixtures used on this project will be as follows:

Asphalt Concrete Base Course	Type B 25.0__	4.4%
Asphalt Concrete Intermediate Course	Type I 19.0__	4.8%
Asphalt Concrete Surface Course	Type S 4.75A	6.8%
Asphalt Concrete Surface Course	Type SA-1	6.8%
Asphalt Concrete Surface Course	Type SF 9.5A	6.7%
Asphalt Concrete Surface Course	Type S 9.5__	6.0%
Asphalt Concrete Surface Course	Type S 12.5__	5.6%

The actual asphalt binder content will be established during construction by the Engineer within the limits established in the *2012 Standard Specifications*.

**ASPHALT PLANT MIXTURES:**

(7-1-95)

609

SP6 R20

Place asphalt concrete base course material in trench sections with asphalt pavement spreaders made for the purpose or with other equipment approved by the Engineer.

**PRICE ADJUSTMENT - ASPHALT BINDER FOR PLANT MIX:**

(11-21-00)

620

SP6 R25

Price adjustments for asphalt binder for plant mix will be made in accordance with Section 620 of the *2012 Standard Specifications*.

The base price index for asphalt binder for plant mix is \$ **410.00** per ton.

This base price index represents an average of F.O.B. selling prices of asphalt binder at supplier's terminals on **December 1, 2015**.

**FINAL SURFACE TESTING NOT REQUIRED:**

(5-18-04) (Rev. 5-15-12)

610

SP6 R45

Final surface testing is not required on this project.

**GUARDRAIL ANCHOR UNITS, TYPE 350 (TL-3):**

(4-20-04) (Rev. 7-21-15)

862

SP08 R065

**Description**

Furnish and install guardrail anchor units in accordance with the details in the plans, the applicable requirements of Section 862 of the *2012 Standard Specifications*, and at locations shown in the plans.

**Materials**

Furnish guardrail anchor units listed on the NCDOT Approved Products List at <https://apps.dot.state.nc.us/vendor/approvedproducts/> or approved equal.

Prior to installation the Contractor shall submit to the Engineer:

- (A) FHWA acceptance letter for each guardrail anchor unit certifying it meets the requirements of NCHRP Report 350, Test Level 3, in accordance with Article 106-2 of the *2012 Standard Specifications*.
- (B) Certified working drawings and assembling instructions from the manufacturer for each guardrail anchor unit in accordance with Article 105-2 of the *2012 Standard Specifications*.

No modifications shall be made to the guardrail anchor unit without the express written permission from the manufacturer. Perform installation in accordance with the details in the plans, and details and assembling instructions furnished by the manufacturer.

**Construction Methods**

Guardrail end delineation is required on all approach and trailing end sections for both temporary and permanent installations. Guardrail end delineation consists of yellow reflective sheeting applied to the entire end section of the guardrail in accordance with Article 1088-3 of the *2012 Standard Specifications* and is incidental to the cost of the guardrail anchor unit.

**Measurement and Payment**

Measurement and payment will be made in accordance with Article 862-6 of the *2012 Standard Specifications*.

Payment will be made under:

<b>Pay Item</b>	<b>Pay Unit</b>
Guardrail Anchor Units, Type 350	Each

**VINYL COATED GLARE SCREEN (GUARDRAIL MOUNTED):**

(7-1-95) (Rev. 7-18-06)

SP8 R80(Rev)

**Description**

The work covered by this provision consists of constructing a vinyl coated galvanized steel chain link fence/glare screen mounted on vinyl coated galvanized steel posts in accordance with the *Standard Specifications, Roadway Standard Drawings*, plans, and these provisions. Apply the vinyl coating over the galvanizing.

**Materials**

Provide steel pipe posts meeting the requirement of Subarticle 1050-3 of the *Standard Specifications* for vinyl coated steel pipe posts.

Provide vinyl coated chain link fabric that complies with the plans and Article 1050-6 of the *Standard Specifications*.

Provide vinyl coated fittings and accessories meeting the requirements of Article 1050-7 of the *Standard Specifications* except where otherwise required by the plans.

Provide vinyl coated tension wire, hog rings, post caps, and tie wire meeting the requirements of Article 1050-7 of the *Standard Specifications*.

**Construction Methods**

Erect the vinyl coated glare screen/chain link fence in accordance with the *Standard Specifications, Roadway Standard Drawings* (Std. Dwg. No. 866.05), plans, and as directed by the Engineer.

**Measurement and Payment**

*Vinyl Coated Glare Screen (Guardrail Mounted)* will be measured and paid for as the actual number of linear feet of vinyl coated glare screen/chain link fence fabric, measured in place from center of end post to center of end post that has been completed and accepted. Such price and payment will be full compensation for all work covered by this provision including but not limited to furnishing and installing all posts, fittings, hardware, fabric, tie wires, and tension

wire, and all other materials, labor, tools, equipment, and incidentals necessary to complete the work.

Payment will be made under:

<b>Pay Item</b>	<b>Pay Unit</b>
Vinyl Coated Glare Screen (Guardrail Mounted)	Linear Foot

**CONCRETE STEPS:**

(11-18-08)

SPI 8-03

**Description**

Construct reinforced concrete steps in accordance with the contract documents.

**Materials**

Refer to Division 10:

<b>Item</b>	<b>Section</b>
Portland Cement Concrete, Class B	1000
Curing Agents	1026
Steel Bar Reinforcement	1070-2

**Construction Methods**

Construct concrete in accordance with Section 825 of the *Standard Specifications*, except as otherwise provided herein. Furnish and place reinforcement, as shown on the plans, in accordance with Section 425 of the *Standard Specifications*. Give formed surfaces of the concrete a rubbed finish. Give unformed surfaces a float finish. Compact backfill to a degree comparable to the adjacent undisturbed material.

**Measurement and Payment**

*Concrete Steps* will be measured and paid for in cubic yards computed from the dimensions shown on the plans or established by the Engineer that has been incorporated into the completed and accepted steps. Work includes but is not limited to excavation and backfilling, furnishing and placing concrete, reinforcing steel, and all labor, tools, materials, equipment and incidentals necessary to complete the work.

Payment will be made under:

<b>Pay Item</b>	<b>Pay Unit</b>
Concrete Steps	Cubic Yard

**DETECTABLE WARNINGS FOR PROPOSED CURB RAMPS:**

(6-15-10) (Rev. 8-16-11)

848

SP8 R126

**Description**

Construct detectable warnings consisting of integrated raised truncated domes on proposed concrete curb ramps in accordance with the *2012 Standard Specifications*, plan details, the requirements of the *28 CFR Part 36 ADA Standards for Accessible Design* and this provision.

**Materials**

Detectable warning for proposed curb ramps shall consist of integrated raised truncated domes. The description, size and spacing shall conform to Section 848 of the *2012 Standard Specifications*.

Use material for detectable warning systems as shown herein. Material and coating specifications must be stated in the Manufacturers Type 3 Certification and all Detectable Warning systems must be on the NCDOT Approved Products List.

Install detectable warnings created from one of the following materials: precast concrete blocks or bricks, clay paving brick, gray or ductile iron castings, mild steel, stainless steel, and engineered plastics, rubber or composite tile. Only one material type for detectable warning will be permitted per project, unless otherwise approved by the Engineer.

- (A) Detectable Warnings shall consist of a base with integrated raised truncated domes, and when constructed of precast concrete they shall conform to the material requirements of Article 848-2 of the *2012 Standard Specifications*.
- (B) Detectable Warnings shall consist of a base with integrated raised truncated domes, and may be comprised of other materials including, but not limited, to clay paving brick, gray iron or ductile iron castings, mild steel, stainless steel, and engineered plastics, rubber or composite tile, which are cast into the concrete of the curb ramps. The material shall have an integral color throughout the thickness of the material. The detectable warning shall include fasteners or anchors for attachment in the concrete and shall be furnished as a system from the manufacturer.

Prior to installation, the Contractor shall submit to the Engineer assembling instructions from the manufacturer for each type of system used in accordance with Article 105-2 of the *2012 Standard Specifications*. The system shall be furnished as a kit containing all consumable materials and consumable tools, required for the application. They shall be capable of being affixed to or anchored in the concrete curb ramp, including green concrete (concrete that has set but not appreciably hardened). The system shall be solvent free and contain no volatile organic compounds (VOC). The static coefficient of friction shall be 0.8 or greater when measured on top of the truncated domes and when measured between the domes in accordance with ASTM C1028 (dry and wet). The system shall be resistant to deterioration due to exposure to sunlight, water, salt or

adverse weather conditions and impervious to degradation by motor fuels, lubricants and antifreeze.

- (C) When steel or gray iron or ductile iron casting products are provided, only products that meet the requirements of Subarticle 106-1(B) of the *2012 Standard Specifications* may be used. Submit to the Engineer a Type 6 Certification, catalog cuts and installation procedures at least 30 days prior to installation for all.

### **Construction Methods**

- (A) Prior to placing detectable warnings in proposed concrete curb ramps, adjust the existing subgrade to the proper grade and in accordance with Article 848-3 of the *2012 Standard Specifications*.
- (B) Install all detectable warning in proposed concrete curb ramps in accordance with the manufacturer's recommendations.

### **Measurement and Payment**

Detectable Warnings installed for construction of proposed curb ramps will not be paid for separately. Such payment will be included in the price bid for *Concrete Curb Ramps*.

**MATERIALS:**

(2-21-12) (Rev. 10-20-15) 1000, 1002, 1005, 1018, 1024, 1050, 1056, 1074, 1078, 1080, 1081, 1086, 1084, 1087, 1092 SP10 R01

Revise the *2012 Standard Specifications* as follows:

**Page 10-1, Article 1000-1, DESCRIPTION, lines 9-10**, replace the last sentence of the first paragraph with the following:

Type IL, IP, IS or IT blended cement may be used instead of Portland cement.

**Page 10-1, Article 1000-1, DESCRIPTION, line 14**, add the following:

If any change is made to the mix design, submit a new mix design (with the exception of an approved pozzolan source change).

If any major change is made to the mix design, also submit new test results showing the mix design conforms to the criteria. Define a major change to the mix design as:

- (1) A source change in coarse aggregate, fine aggregate or cement.
- (2) A pozzolan class or type change (e.g. Class F fly ash to Class C fly ash).
- (3) A quantitative change in coarse aggregate (applies to an increase or decrease greater than 5%), fine aggregate (applies to an increase or decrease greater than 5%), water (applies to an increase only), cement (applies to a decrease only), or pozzolan (applies to an increase or decrease greater than 5%).

Use materials which do not produce a mottled appearance through rusting or other staining of the finished concrete surface.

**Page 10-1, Article 1000-2, MATERIALS, line 16; Page 10-8, Subarticle 1000-7(A), Materials, line 8; and Page 10-18, Article 1002-2, MATERIALS, line 9**, add the following to the table of item references:

<b>Item</b>	<b>Section</b>
Type IL Blended Cement	1024-1

**Page 10-1, Subarticle 1000-3(A), Composition and Design, lines 25-27**, replace the second paragraph with the following:

Fly ash may be substituted for cement in the mix design up to 30% at a rate of 1.0 lb of fly ash to each pound of cement replaced.

**Page 10-2, Subarticle 1000-3(A), Composition and Design, lines 12-21**, delete the third paragraph through the sixth paragraph beginning with "If any change is made to the mix design, submit..." through "... (applies to a decrease only)."

Page 10-5, Table 1000-1, REQUIREMENTS FOR CONCRETE, replace with the following:

TABLE 1000-1 REQUIREMENTS FOR CONCRETE											
Class of Concrete	Min. Comp. Strength at 28 days	Maximum Water-Cement Ratio				Consistency Max. Slump		Cement Content			
		Air-Entrained Concrete		Non Air-Entrained Concrete		Vibrated	Non-Vibrated	Vibrated		Non-Vibrated	
		Rounded Aggregate	Angular Aggregate	Rounded Aggregate	Angular Aggregate			Min.	Max.	Min.	Max.
Units	psi					inch	inch	lb/cy	lb/cy	lb/cy	lb/cy
AA	4,500	0.381	0.426	-	-	3.5	-	639	715	-	-
AA Slip Form	4,500	0.381	0.426	-	-	1.5	-	639	715	-	-
Drilled Pier	4,500	-	-	0.450	0.450	-	5-7 dry 7-9 wet	-	-	640	800
A	3,000	0.488	0.532	0.550	0.594	3.5	4	564	-	602	-
B	2,500	0.488	0.567	0.559	0.630	1.5 machine-placed 2.5 hand-placed	4	508	-	545	-
Sand Light-weight	4,500	-	0.420	-	-	4	-	715	-	-	-
Latex Modified	3,000 7 day	0.400	0.400	-	-	6	-	658	-	-	-
Flowable Fill excavatable	150 max. at 56 days	as needed	as needed	as needed	as needed	-	Flow-able	-	-	40	100
Flowable Fill non-excavatable	125	as needed	as needed	as needed	as needed	-	Flow-able	-	-	100	as needed
Pavement	4,500 design, field 650 flexural, design only	0.559	0.559	-	-	1.5 slip form 3.0 hand place	-	526	-	-	-
Precast	See Table 1077-1	as needed	as needed	-	-	6	as needed	as needed	as needed	as needed	as needed
Prestress	per contract	See Table 1078-1	See Table 1078-1	-	-	8	-	564	as needed	-	-

Page 10-6, Subarticle 1000-4(I), Use of Fly Ash, lines 36-2, replace the first paragraph with the following:

Fly ash may be substituted for cement in the mix design up to 30% at a rate of 1.0 lb of fly ash to each pound of cement replaced. Use Table 1000-1 to determine the maximum allowable water-cementitious material (cement + fly ash) ratio for the classes of concrete listed.

Page 10-7, Table 1000-3, MAXIMUM WATER-CEMENTITIOUS MATERIAL RATIO, delete the table.



**Page 10-7, Article 1000-5, HIGH EARLY STRENGTH PORTLAND CEMENT CONCRETE, lines 30-31,** delete the second sentence of the third paragraph.

**Page 10-19, Article 1002-3, SHOTCRETE FOR TEMPORARY SUPPORT OF EXCAVATIONS, line 30,** add the following at the end of Section 1002:

**(H) Handling and Storing Test Panels**

Notify the Area Materials Engineer when preconstruction or production test panels are made within 24 hours of shooting the panels. Field cure and protect test panels from damage in accordance with ASTM C1140 until the Department transports panels to the Materials and Tests Regional Laboratory for coring.

Page 10-23, Table 1005-1, AGGREGATE GRADATION-COARSE AGGREGATE, replace with the following:

<b>TABLE 1005-1 AGGREGATE GRADATION - COARSE AGGREGATE</b>													
<b>Percentage of Total by Weight Passing</b>													
<b>Std. Size #</b>	<b>2"</b>	<b>1 1/2"</b>	<b>1"</b>	<b>3/4"</b>	<b>1/2"</b>	<b>3/8"</b>	<b>#4</b>	<b>#8</b>	<b>#10</b>	<b>#16</b>	<b>#40</b>	<b>#200</b>	<b>Remarks</b>
4	100	90-100	20-55	0-15	-	0-5	-	-	-	-	-	A	Asphalt Plant Mix
467M	100	95-100	-	35-70	-	0-30	0-5	-	-	-	-	A	Asphalt Plant Mix
5	-	100	90-100	20-55	0-10	0-5	-	-	-	-	-	A	AST, Sediment Control Stone
57	-	100	95-100	-	25-60	-	0-10	0-5	-	-	-	A	AST, Str. Concrete, Shoulder Drain, Sediment Control Stone
57M	-	100	95-100	-	25-45	-	0-10	0-5	-	-	-	A	AST, Concrete Pavement
6M	-	-	100	90-100	20-55	0-20	0-8	-	-	-	-	A	AST
67	-	-	100	90-100	-	20-55	0-10	0-5	-	-	-	A	AST, Str. Concrete, Asphalt Plant Mix
78M	-	-	-	100	98-100	75-100	20-45	0-15	-	-	-	A	Asphalt Plant Mix, AST, Str. Conc. Weep Hole Drains
14M	-	-	-	-	-	100	35-70	5-20	-	0-8	-	A	Asphalt Plant Mix, AST, Weep Hole Drains, Str. Concrete
9	-	-	-	-	-	100	85-100	10-40	-	0-10	-	A	AST
ABC	-	100	75-97	-	55-80	-	35-55	-	25-45	-	14-30	4-12 <sup>B</sup>	Aggregate Base Course, Aggregate Stabilization
ABC (M)	-	100	75-100	-	45-79	-	20-40	-	0-25	-	-	0-12 <sup>B</sup>	Maintenance Stabilization
Light-weight C	-	-	-	-	100	80-100	5-40	0-20	-	0-10	-	0-2.5	AST

- A. See Subarticle 1005-4(A).
- B. See Subarticle 1005-4(B).
- C. For Lightweight Aggregate used in Structural Concrete, see Subarticle 1014-2(E)(6).

**Page 10-40, Tables 1018-1 and 1018-2, PIEDMONT, WESTERN AND COASTAL AREA CRITERIA FOR ACCEPTANCE OF BORROW MATERIAL**, under second column in both tables, replace second row with the following:

Acceptable, but not to be used in the top 3 ft of embankment or backfill

**Page 10-46, Article 1024-1, PORTLAND CEMENT, line 33**, add the following as the ninth paragraph:

Use Type IL blended cement that meets AASHTO M 240, except that the limestone content is limited to between 5 and 12% by weight and the constituents shall be interground. Class F fly ash can replace a portion of Type IL blended cement and shall be replaced as outlined in Subarticle 1000-4(I) for Portland cement. For mixes that contain cement with alkali content between 0.6% and 1.0% and for mixes that contain a reactive aggregate documented by the Department, use a pozzolan in the amount shown in Table 1024-1.

**Page 10-46, Table 1024-1, POZZOLANS FOR USE IN PORTLAND CEMENT CONCRETE**, replace with the following:

<b>TABLE 1024-1 POZZOLANS FOR USE IN PORTLAND CEMENT CONCRETE</b>	
<b>Pozzolan</b>	<b>Rate</b>
Class F Fly Ash	20% - 30% by weight of required cement content with 1.0 lb Class F fly ash per lb of cement replaced
Ground Granulated Blast Furnace Slag	35%-50% by weight of required cement content with 1.0 lb slag per lb of cement replaced
Microsilica	4%-8% by weight of required cement content with 1.0 lb microsilica per lb of cement replaced

**Page 10-47, Subarticle 1024-3(B), Approved Sources, lines 16-18**, replace the second sentence of the second paragraph with the following:

Tests shall be performed by AASHTO's designated National Transportation Product Evaluation Program (NTPEP) laboratory for concrete admixture testing.

**Page 10-65, Article 1050-1, GENERAL, line 41**, replace the first sentence with the following:

All fencing material and accessories shall meet Section 106.

**Page 10-73, Article 1056-1, DESCRIPTION, lines 7-8**, delete the first sentence of the second paragraph and replace with the following:

Use geotextile fabrics that are on the NCDOT Approved Products List.

**Page 10-73, Article 1056-2, HANDLING AND STORING, line 17**, replace "mechanically stabilized earth (MSE) wall faces" with "temporary wall faces".

**Page 10-73, Article 1056-4, GEOTEXTILES, line 33,** add the following after the first sentence in the second paragraph:

Geotextiles will be identified by the product name printed directly on the geotextile. When geotextiles are not marked with a product name or marked with only a manufacturing plant identification code, geotextiles will be identified by product labels attached to the geotextile wrapping. When identification is based on labels instead of markings, unwrap geotextiles just before use in the presence of the Engineer to confirm that the product labels on both ends of the outside of the geotextile outer wrapping match the labels affixed to both ends of the inside of the geotextile roll core. Partial geotextile roles without the product name printed on the geotextile or product labels affixed to the geotextile roll core may not be used.

Page 10-74, Table 1056-1, GEOTEXTILE REQUIREMENTS, replace with the following:

TABLE 1056-1 GEOTEXTILE REQUIREMENTS						
Property	Requirement					Test Method
	Type 1	Type 2	Type 3 <sup>A</sup>	Type 4	Type 5 <sup>B</sup>	
<i>Typical Application</i>	<i>Shoulder Drains</i>	<i>Under Rip Rap</i>	<i>Temporary Silt Fence</i>	<i>Soil Stabilization</i>	<i>Temporary Walls</i>	
Elongation (MD & CD)	≥ 50%	≥ 50%	≤ 25%	< 50%	< 50%	ASTM D4632
Grab Strength (MD & CD)	Table 1 <sup>D</sup> , Class 3	Table 1 <sup>D</sup> , Class 1	100 lb <sup>C</sup>	Table 1 <sup>D</sup> , Class 3	-	ASTM D4632
Tear Strength (MD & CD)			-			ASTM D4533
Puncture Strength			-			ASTM D6241
Ultimate Tensile Strength (MD & CD)	-	-	-	-	2,400 lb/ft <sup>C</sup> (unless required otherwise in the contract)	ASTM D4595
Permittivity	Table 2 <sup>D</sup> , 15% to 50% <i>in Situ</i> Soil Passing No. 200 <sup>E</sup>		Table 7 <sup>D</sup>	Table 5 <sup>D</sup>	0.20 sec <sup>-1,C</sup>	ASTM D4491
Apparent Opening Size					0.60 mm <sup>F</sup>	ASTM D4751
UV Stability (Retained Strength)					70% <sup>C, G</sup>	ASTM D4355

- A. Minimum roll width of 36" required.
- B. Minimum roll width of 13 ft required.
- C. MARV per Article 1056-3.
- D. AASHTO M 288.
- E. US Sieve No. per AASHTO M 92.
- F. Maximum average roll value.
- G. After 500 hours of exposure.

Page 10-74, Article 1056-5, GEOCOMPOSITES, lines 7-8, replace the first sentence with the following:

Provide geocomposite drain strips with a width of at least 12" and Type 1 geotextiles attached to drainage cores that meet Table 1056-2.

**Page 10-115, Subarticle 1074-7(B), Gray Iron Castings, lines 10-11,** replace the first two sentences with the following:

Supply gray iron castings meeting all facets of AASHTO M 306 excluding proof load. Proof load testing will only be required for new casting designs during the design process, and conformance to M306 loading (40,000 lbs.) will be required only when noted on the design documents.

**Page 10-126, Table 1078-1, REQUIREMENTS FOR CONCRETE,** replace with the following:

<b>TABLE 1078-1 REQUIREMENTS FOR CONCRETE</b>		
<b>Property</b>	<b>28 Day Design Compressive Strength 6,000 psi or less</b>	<b>28 Day Design Compressive Strength greater than 6,000 psi</b>
Maximum Water/Cementitious Material Ratio	0.45	0.40
Maximum Slump without HRWR	3.5"	3.5"
Maximum Slump with HRWR	8"	8"
Air Content (upon discharge into forms)	5 + 2%	5 + 2%

**Page 10-151, Article 1080-4, INSPECTION AND SAMPLING, lines 18-22,** replace (B), (C) and (D) with the following:

- (B) At least 3 panels prepared as specified in 5.5.10 of AASHTO M 300, Bullet Hole Immersion Test.
- (C) At least 3 panels of 4"x6"x1/4" for the Elcometer Adhesion Pull Off Test, ASTM D4541.
- (D) A certified test report from an approved independent testing laboratory for the Salt Fog Resistance Test, Cyclic Weathering Resistance Test, and Bullet Hole Immersion Test as specified in AASHTO M 300.
- (E) A certified test report from an approved independent testing laboratory that the product has been tested for slip coefficient and meets AASHTO M253, Class B.

**Page 10-161, Subarticle 1081-1(A), Classifications, lines 29-33,** delete first 3 sentences of the description for Type 2 and replace with the following:

**Type 2** - A low-modulus, general-purpose adhesive used in epoxy mortar repairs. It may be used to patch spalled, cracked or broken concrete where vibration, shock or expansion and contraction are expected.

**Page 10-162, Subarticle 1081-1(A), Classifications, lines 4-7,** delete the second and third sentences of the description for Type 3A. **Lines 16-22,** delete Types 6A, 6B and 6C.

**Page 10-162, Subarticle 1081-1(B), Requirements, lines 26-30**, replace the second paragraph with the following:

For epoxy resin systems used for embedding dowel bars, threaded rods, rebar, anchor bolts and other fixtures in hardened concrete, the manufacturer shall submit test results showing that the bonding system will obtain 125% of the specified required yield strength of the fixture. Furnish certification that, for the particular bolt grade, diameter and embedment depth required, the anchor system will not fail by adhesive failure and that there is no movement of the anchor bolt. For certification and anchorage, use 3,000 psi as the minimum Portland cement concrete compressive strength used in this test. Use adhesives that meet Section 1081.

List the properties of the adhesive on the container and include density, minimum and maximum temperature application, setting time, shelf life, pot life, shear strength and compressive strength.

Page 10-163, Table 1081-1, PROPERTIES OF MIXED EPOXY RESIN SYSTEMS, replace with the following:

Property	Type 1	Type 2	Type 3	Type 3A	Type 4A	Type 4B	Type 5
Viscosity-Poises at 77°F ± 2°F	Gel	10-30	25-75	Gel	40-150	40-150	1-6
Spindle No.	-	3	4	--	4	4	2
Speed (RPM)	-	20	20	--	10	10	50
Pot Life (Minutes)	20-50	30-60	20-50	5-50	40-80	40-80	20-60
Minimum Tensile Strength at 7 days (psi)	1,500	2,000	4,000	4,000	1,500	1,500	4,000
Tensile Elongation at 7 days (%)	30 min.	30 min.	2-5	2-5	5-15	5-15	2-5
Min. Compressive Strength of 2" mortar cubes at 24 hours	3,000 (Neat)	4,000-	6,000-	6,000 (Neat)	3,000	3,000	6,000
Min. Compressive Strength of 2" mortar cubes at 7 days	5,000 (Neat)	-	-	-	-	5,000	-
Maximum Water Absorption (%)	1.5	1.0	1.0	1.5	1.0	1.0	1.0
Min. Bond Strength Slant Shear Test at 14 days (psi)	1,500	1,500	2,000	2,000	1,500	1,500	1,500

Page 10-164, Subarticle 1081-1(E), Prequalification, lines 31-33, replace the second sentence of the first paragraph with the following:

Manufacturers choosing to supply material for Department jobs must submit an application through the Value Management Unit with the following information for each type and brand name:



**Page 10-164, Subarticle 1081-1(E)(3), line 37**, replace with the following:

(3) Type of the material in accordance with Articles 1081-1 and 1081-4,

**Page 10-165, Subarticle 1081-1(E)(6), line 1**, in the first sentence of the first paragraph replace “AASHTO M 237” with “the specifications”.

**Page 10-165, Subarticle 1081-1(E), Prequalification, line 9-10**, delete the second sentence of the last paragraph.

**Page 10-165, Subarticle 1081-1(F), Acceptance, line 14**, in the first sentence of the first paragraph replace “Type 1” with “Type 3”.

**Page 10-169, Subarticle 1081-3(G), Anchor Bolt Adhesives**, delete this subarticle.

**Page 10-170, Article 1081-3, HOT BITUMEN, line 9**, add the following at the end of Section 1081:

#### **1081-4 EPOXY RESIN ADHESIVE FOR BONDING TRAFFIC MARKINGS**

##### **(A) General**

This section covers epoxy resin adhesive for bonding traffic markers to pavement surfaces.

##### **(B) Classification**

The types of epoxies and their uses are as shown below:

**Type I** – Rapid Setting, High Viscosity, Epoxy Adhesive. This type of adhesive provides rapid adherence to traffic markers to the surface of pavement.

**Type II** – Standard Setting, High Viscosity, Epoxy Adhesive. This type of adhesive is recommended for adherence of traffic markers to pavement surfaces when rapid set is not required.

**Type III** – Rapid Setting, Low Viscosity, Water Resistant, Epoxy Adhesive. This type of rapid setting adhesive, due to its low viscosity, is appropriate only for use with embedded traffic markers.

**Type IV** – Standard Set Epoxy for Blade Deflecting-Type Plowable Markers.

##### **(C) Requirements**

Epoxies shall conform to the requirements set forth in AASHTO M 237.

##### **(D) Prequalification**

Refer to Subarticle 1081-1(E).

##### **(E) Acceptance**

Refer to Subarticle 1081-1(F).

**Page 10-173, Article 1084-2, STEEL SHEET PILES, lines 37-38**, replace first paragraph with the following:

Steel sheet piles detailed for permanent applications shall be hot rolled and meet ASTM A572 or ASTM A690 unless otherwise required by the plans. Steel sheet piles shall be coated as required

by the plans. Galvanized sheet piles shall be coated in accordance with Section 1076. Metallized sheet piles shall be metallized in accordance to the Project Special Provision “Thermal Sprayed Coatings (Metallization)” with an 8 mil, 99.9% aluminum alloy coating and a 0.5 mil seal coating. Any portion of the metallized sheet piling encased in concrete shall receive a barrier coat. The barrier coat shall be an approved waterborne coating with a low-viscosity which readily absorbs into the pores of the aluminum thermal sprayed coating. The waterborne coating shall be applied at a spreading rate that results in a theoretical 1.5 mil dry film thickness. The manufacturer shall issue a letter of certification that the resin chemistry of the waterborne coating is compatible with the 99.9% aluminum thermal sprayed alloy and suitable for tidal water applications.

**Page 10-174, Subarticle 1086-1(B)(1), Epoxy, lines 18-24,** replace with the following:

The epoxy shall meet Article 1081-4.

The 2 types of epoxy adhesive which may be used are Type I, Rapid Setting, and Type II, Standard Setting. Use Type II when the pavement temperature is above 60°F or per the manufacturer’s recommendations whichever is more stringent. Use Type I when the pavement temperature is between 50°F and 60°F or per the manufacturer’s recommendations whichever is more stringent. Epoxy adhesive Type I, Cold Set, may be used to attach temporary pavement markers to the pavement surface when the pavement temperature is between 32°F and 50°F or per the manufacturer’s recommendations whichever is more stringent.

**Page 10-175, Subarticle 1086-2(E), Epoxy Adhesives, line 27,** replace “Section 1081” with “Article 1081-4”.

**Page 10-177, Subarticle 1086-3(E), Epoxy Adhesives, line 22,** replace “Section 1081” with “Article 1081-4”.

**Page 10-179, Subarticle 1087-4(A), Composition, lines 39-41,** replace the third paragraph with the following:

All intermixed and drop-on glass beads shall not contain more than 75 ppm arsenic or 200 ppm lead.

**Page 10-180, Subarticle 1087-4(B), Physical Characteristics, line 8,** replace the second paragraph with the following:

All intermixed and drop-on glass beads shall comply with NCGS § 136-30.2 and 23 USC § 109(r).

**Page 10-181, Subarticle 1087-7(A), Intermixed and Drop-on Glass Beads, line 24,** add the following after the first paragraph:

Use X-ray Fluorescence for the normal sampling procedure for intermixed and drop-on beads, without crushing, to check for any levels of arsenic and lead. If any arsenic or lead is detected, the sample shall be crushed and repeat the test using X-ray Fluorescence. If the X-ray Fluorescence test shows more than a LOD of 5 ppm, test the beads using United States Environmental Protection Agency Method 6010B, 6010C or 3052 for no more than 75 ppm arsenic or 200 ppm lead.

**SELECT MATERIAL, CLASS III, TYPE 3:**

(1-17-12)

1016, 1044

SP10 R05

Revise the *2012 Standard Specifications* as follows:

**Page 10-39, Article 1016-3, CLASS III**, add the following after line 14:

**Type 3 Select Material**

Type 3 select material is a natural or manufactured fine aggregate material meeting the following gradation requirements and as described in Sections 1005 and 1006:

Percentage of Total by Weight Passing							
3/8"	#4	#8	#16	#30	#50	#100	#200
100	95-100	65-100	35-95	15-75	5-35	0-25	0-8

**Page 10-39, Article 1016-3, CLASS III, line 15**, replace “either type” with “Type 1, Type 2 or Type 3”.

**Page 10-62, Article 1044-1, line 36**, delete the sentence and replace with the following:

Subdrain fine aggregate shall meet Class III select material, Type 1 or Type 3.

**Page 10-63, Article 1044-2, line 2**, delete the sentence and replace with the following:

Subdrain coarse aggregate shall meet Class V select material.

**SHOULDER AND SLOPE BORROW:**

(3-19-13)

1019

SP10 R10

Use soil in accordance with Section 1019 of the *2012 Standard Specifications*. Use soil consisting of loose, friable, sandy material with a PI greater than 6 and less than 25 and a pH ranging from 5.5 to 7.0.

Soil with a pH ranging from 4.0 to 5.5 will be accepted without further testing if additional limestone is provided in accordance with the application rates shown in Table 1019-1A. Soil type is identified during the soil analysis. Soils with a pH above 7.0 require acidic amendments to be added. Submit proposed acidic amendments to the Engineer for review and approval. Soils with a pH below 4.0 or that do not meet the PI requirements shall not be used.

<b>pH TEST RESULT</b>	<b>Sandy Soils Additional Rate (lbs. / Acre)</b>	<b>Silt Loam Soils Additional Rate (lbs. / Acre)</b>	<b>Clay Loam Soils Additional Rate (lbs. / Acre)</b>
4.0 - 4.4	1,000	4,000	6,000
4.5 - 4.9	500	3,000	5,000
5.0 - 5.4	NA	2,000	4,000

Note: Limestone application rates shown in this table are in addition to the standard rate of 4000 lbs. / acre required for seeding and mulching.

No direct payment will be made for providing additional lime or acidic amendments for Ph adjustment.

**GROUT PRODUCTION AND DELIVERY:**

(3-17-15)

1003

SP10 R20

Revise the *2012 Standard Specifications* as follows:

Replace Section 1003 with the following:

**SECTION 1003  
GROUT PRODUCTION AND DELIVERY**

**1003-1 DESCRIPTION**

This section addresses cement grout to be used for structures, foundations, retaining walls, concrete barriers, embankments, pavements and other applications in accordance with the contract. Produce non-metallic grout composed of Portland cement and water and at the Contractor's option or as required, aggregate and pozzolans. Include chemical admixtures as required or needed. Provide sand cement or neat cement grout as required. Define "sand cement grout" as grout with only fine aggregate and "neat cement grout" as grout without aggregate.

The types of grout with their typical uses are as shown below:

**Type 1** – A cement grout with only a 3-day strength requirement and a fluid consistency that is typically used for filling subsurface voids.

**Type 2** – A nonshrink grout with strength, height change and flow conforming to ASTM C1107 that is typically used for foundations, ground anchors and soil nails.

**Type 3** – A nonshrink grout with high early strength and freeze-thaw durability requirements that is typically used in pile blockouts, grout pockets, shear keys, dowel holes and recesses for concrete barriers and structures.

**Type 4** – A neat cement grout with low strength, a fluid consistency and high fly ash content that is typically used for slab jacking.

**Type 5** – A low slump, low mobility sand cement grout with minimal strength that is typically used for compaction grouting.

**1003-2 MATERIALS**

Refer to Division 10.

<b>Item</b>	<b>Section</b>
Chemical Admixtures	1024-3
Fine Aggregate	1014-1
Fly Ash	1024-5
Ground Granulated Blast Furnace Slag	1024-6
Portland Cement	1024-1
Silica Fume	1024-7
Water	1024-4

Do not use grout that contains soluble chlorides or more than 1% soluble sulfate. At the Contractor's option, use an approved packaged grout instead of the materials above except for water. Use packaged grouts that are on the NCDOT Approved Products List.

Use admixtures for grout that are on the NCDOT Approved Products List or other admixtures in accordance with Subarticle 1024-3(E) except do not use concrete additives or unclassified or other admixtures in Type 4 or 5 grout. Use Class F fly ash for Type 4 grout and Type II Portland cement for Type 5 grout.

Use well graded rounded aggregate with a gradation, liquid limit (LL) and plasticity index (PI) that meet Table 1003-1 for Type 5 grout. Fly ash may be substituted for a portion of the fines in the aggregate. Do not use any other pozzolans in Type 5 grout.

<b>Gradation</b>		<b>Maximum Liquid Limit</b>	<b>Maximum Plasticity Index</b>
<b>Sieve Designation per AASHTO M 92</b>	<b>Percentage Passing (% by weight)</b>		
3/8"	100	N/A	N/A
No. 4	70 – 95		
No. 8	50 – 90		
No. 16	30 – 80		
No. 30	25 – 70		
No. 50	20 – 50		
No. 100	15 – 40	25	10
No. 200	10 – 30		

**1003-3 COMPOSITION AND DESIGN**

When using an approved packaged grout, a grout mix design submittal is not required. Otherwise, submit proposed grout mix designs for each grout mix to be used in the work. Mixes for all grout shall be designed by a Certified Concrete Mix Design Technician or

an Engineer licensed by the State of North Carolina. Mix proportions shall be determined by a testing laboratory approved by the Department. Base grout mix designs on laboratory trial batches that meet Table 1003-2 and this section. With permission, the Contractor may use a quantity of chemical admixture within the range shown on the current list of approved admixtures maintained by the Materials and Tests Unit.

Submit grout mix designs in terms of saturated surface dry weights on Materials and Tests Form 312U at least 35 days before proposed use. Adjust batch proportions to compensate for surface moisture contained in the aggregates at the time of batching. Changes in the saturated surface dry mix proportions will not be permitted unless revised grout mix designs have been submitted to the Engineer and approved.

Accompany Materials and Tests Form 312U with a listing of laboratory test results of compressive strength, density and flow or slump and if applicable, aggregate gradation, durability and height change. List the compressive strength of at least three 2" cubes at the age of 3 and 28 days.

The Engineer will review the grout mix design for compliance with the contract and notify the Contractor as to its acceptability. Do not use a grout mix until written notice has been received. Acceptance of the grout mix design or use of approved packaged grouts does not relieve the Contractor of his responsibility to furnish a product that meets the contract. Upon written request from the Contractor, a grout mix design accepted and used satisfactorily on any Department project may be accepted for use on other projects.

Perform laboratory tests in accordance with the following test procedures:

<b>Property</b>	<b>Test Method</b>
Aggregate Gradation <sup>A</sup>	AASHTO T 27
Compressive Strength	AASHTO T 106
Density (Unit Weight)	AASHTO T 121, AASHTO T 133 <sup>B</sup> , ANSI/API RP <sup>C</sup> 13B-1 <sup>B</sup> (Section 4, Mud Balance)
Durability	AASHTO T 161 <sup>D</sup>
Flow	ASTM C939 (Flow Cone)
Height Change	ASTM C1090 <sup>E</sup>
Slump	AASHTO T 119

**A.** Applicable to grout with aggregate.

**B.** Applicable to Neat Cement Grout.

**C.** American National Standards Institute/American Petroleum Institute Recommended Practice.

**D.** Procedure A (Rapid Freezing and Thawing in Water) required.

**E.** Moist room storage required.

#### **1003-4 GROUT REQUIREMENTS**

Provide grout types in accordance with the contract. Use grouts with properties that meet Table 1003-2. The compressive strength of the grout will be considered the average

compressive strength test results of three 2" cubes at each age. Make cubes that meet AASHTO T 106 from the grout delivered for the work or mixed on-site. Make cubes at such frequencies as the Engineer may determine and cure them in accordance with AASHTO T 106.

**TABLE 1003-2  
GROUT REQUIREMENTS**

Type of Grout	Minimum Compressive Strength at		Height Change at 28 days	Flow <sup>A</sup> /Slump <sup>B</sup>	Minimum Durability Factor
	3 days	28 days			
1	3,000 psi	–	–	10 – 30 sec	–
2	Table 1 <sup>C</sup>			Fluid Consistency <sup>C</sup>	–
3	5,000 psi	–	0 – 0.2%	Per Accepted Grout Mix Design/ Approved Packaged Grout	80
4 <sup>D</sup>	600 psi	1,500 psi	–	10 – 26 sec	–
5	–	500 psi	–	1 – 3"	–

A. Applicable to Type 1 through 4 grouts.

B. Applicable to Type 5 grout.

C. ASTM C1107.

D. Use Type 4 grout with proportions by volume of 1 part cement and 3 parts fly ash.

### 1003-5 TEMPERATURE REQUIREMENTS

When using an approved packaged grout, follow the manufacturer's instructions for grout and air temperature at the time of placement. Otherwise, the grout temperature at the time of placement shall be not less than 50°F nor more than 90°F. Do not place grout when the air temperature measured at the location of the grouting operation in the shade away from artificial heat is below 40°F.

### 1003-6 ELAPSED TIME FOR PLACING GROUT

Agitate grout continuously before placement. Regulate the delivery so the maximum interval between the placing of batches at the work site does not exceed 20 minutes. Place grout before exceeding the times in Table 1003-3. Measure the elapsed time as the time between adding the mixing water to the grout mix and placing the grout.

<b>TABLE 1003-3 ELAPSED TIME FOR PLACING GROUT (with continuous agitation)</b>		
<b>Air or Grout Temperature, Whichever is Higher</b>	<b>Maximum Elapsed Time</b>	
	<b>No Retarding Admixture Used</b>	<b>Retarding Admixture Used</b>
90°F or above	30 minutes	1 hr. 15 minutes
80°F through 89°F	45 minutes	1 hr. 30 minutes
79°F or below	60 minutes	1 hr. 45 minutes

**1003-7 MIXING AND DELIVERY**

Use grout free of any lumps and undispersed cement. When using an approved packaged grout, mix grout in accordance with the manufacturer's instructions. Otherwise, comply with Articles 1000-8 through 1000-12 to the extent applicable for grout instead of concrete.

**GROUT REFERENCES FOR UTILITY MANHOLES:**

(8-18-15)

1525

SP15 R40

Revise the *2012 Standard Specifications* as follows:

**Page 15-13, Article 1525-2, Materials**, line 9, in the materials table, add the following:

<b>Item</b>	<b>Section</b>
Grout, Type 2	1003

**Page 15-13, Article 1525-2, Materials**, lines 20-21, replace the third paragraph after the materials table with the following:

Use Type 2 grout with properties that meet Table 1003-2 in the *Grout Production and Delivery* provision except provide grout with a plastic consistency in accordance with ASTM C1107.

**Page 15-14, Subarticle 1525-3(B), Installation of Precast Units**, line 22, in the second sentence of the first paragraph, replace “non-shrink grout.” with “grout.”



**STANDARD SPECIAL PROVISION**  
**AVAILABILITY OF FUNDS – TERMINATION OF CONTRACTS**

(5-20-08)

Z-2

*General Statute 143C-6-11. (h) Highway Appropriation* is hereby incorporated verbatim in this contract as follows:

(h) Amounts Encumbered. – Transportation project appropriations may be encumbered in the amount of allotments made to the Department of Transportation by the Director for the estimated payments for transportation project contract work to be performed in the appropriation fiscal year. The allotments shall be multiyear allotments and shall be based on estimated revenues and shall be subject to the maximum contract authority contained in *General Statute 143C-6-11(c)*. Payment for transportation project work performed pursuant to contract in any fiscal year other than the current fiscal year is subject to appropriations by the General Assembly. Transportation project contracts shall contain a schedule of estimated completion progress, and any acceleration of this progress shall be subject to the approval of the Department of Transportation provided funds are available. The State reserves the right to terminate or suspend any transportation project contract, and any transportation project contract shall be so terminated or suspended if funds will not be available for payment of the work to be performed during that fiscal year pursuant to the contract. In the event of termination of any contract, the contractor shall be given a written notice of termination at least 60 days before completion of scheduled work for which funds are available. In the event of termination, the contractor shall be paid for the work already performed in accordance with the contract specifications.

Payment will be made on any contract terminated pursuant to the special provision in accordance with Subarticle 108-13(E) of the *2012 Standard Specifications*.

**STANDARD SPECIAL PROVISION**  
**NCDOT GENERAL SEED SPECIFICATION FOR SEED QUALITY**

(5-17-11)

Z-3

Seed shall be sampled and tested by the North Carolina Department of Agriculture and Consumer Services, Seed Testing Laboratory. When said samples are collected, the vendor shall supply an independent laboratory report for each lot to be tested. Results from seed so sampled shall be final. Seed not meeting the specifications shall be rejected by the Department of Transportation and shall not be delivered to North Carolina Department of Transportation warehouses. If seed has been delivered it shall be available for pickup and replacement at the supplier's expense.

Any re-labeling required by the North Carolina Department of Agriculture and Consumer Services, Seed Testing Laboratory, that would cause the label to reflect as otherwise specified herein shall be rejected by the North Carolina Department of Transportation.

Seed shall be free from seeds of the noxious weeds Johnsongrass, Balloonvine, Jimsonweed, Witchweed, Itchgrass, Serrated Tussock, Showy Crotalaria, Smooth Crotalaria, Sicklepod, Sandbur, Wild Onion, and Wild Garlic. Seed shall not be labeled with the above weed species on the seed analysis label. Tolerances as applied by the Association of Official Seed Analysts will NOT be allowed for the above noxious weeds except for Wild Onion and Wild Garlic.

Tolerances established by the Association of Official Seed Analysts will generally be recognized. However, for the purpose of figuring pure live seed, the found pure seed and found germination percentages as reported by the North Carolina Department of Agriculture and Consumer Services, Seed Testing Laboratory will be used. Allowances, as established by the NCDOT, will be recognized for minimum pure live seed as listed on the following pages.

The specifications for restricted noxious weed seed refers to the number per pound as follows:

<b><u>Restricted Noxious Weed</u></b>	<b><u>Limitations per Lb. Of Seed</u></b>	<b><u>Restricted Noxious Weed</u></b>	<b><u>Limitations per Lb. of Seed</u></b>
Blessed Thistle	4 seeds	Cornflower (Ragged Robin)	27 seeds
Cocklebur	4 seeds	Texas Panicum	27 seeds
Spurred Anoda	4 seeds	Bracted Plantain	54 seeds
Velvetleaf	4 seeds	Buckhorn Plantain	54 seeds
Morning-glory	8 seeds	Broadleaf Dock	54 seeds
Corn Cockle	10 seeds	Curly Dock	54 seeds
Wild Radish	12 seeds	Dodder	54 seeds
Purple Nutsedge	27 seeds	Giant Foxtail	54 seeds
Yellow Nutsedge	27 seeds	Horsenettle	54 seeds
Canada Thistle	27 seeds	Quackgrass	54 seeds
Field Bindweed	27 seeds	Wild Mustard	54 seeds
Hedge Bindweed	27 seeds		

Seed of Pensacola Bahiagrass shall not contain more than 7% inert matter, Kentucky Bluegrass, Centipede and Fine or Hard Fescue shall not contain more than 5% inert matter whereas a maximum of 2% inert matter will be allowed on all other kinds of seed. In addition, all seed shall not contain more than 2% other crop seed nor more than 1% total weed seed. The germination rate as tested by the North Carolina Department of Agriculture shall not fall below 70%, which includes both dormant and hard seed. Seed shall be labeled with not more than 7%, 5% or 2% inert matter (according to above specifications), 2% other crop seed and 1% total weed seed.

Exceptions may be made for minimum pure live seed allowances when cases of seed variety shortages are verified. Pure live seed percentages will be applied in a verified shortage situation. Those purchase orders of deficient seed lots will be credited with the percentage that the seed is deficient.

**FURTHER SPECIFICATIONS FOR EACH SEED GROUP ARE GIVEN BELOW:**

Minimum 85% pure live seed; maximum 1% total weed seed; maximum 2% total other crop seed; maximum 144 restricted noxious weed seed per pound. Seed less than 83% pure live seed will not be approved.

Sericea Lespedeza  
Oats (seeds)

Minimum 80% pure live seed; maximum 1% total weed seed; maximum 2% total other crop; maximum 144 restricted noxious weed seed per pound. Seed less than 78% pure live seed will not be approved.

Tall Fescue (all approved varieties)	Bermudagrass
Kobe Lespedeza	Browntop Millet
Korean Lespedeza	German Millet – Strain R
Weeping Lovegrass	Clover – Red/White/Crimson
Carpetgrass	

Minimum 78% pure live seed; maximum 1% total weed seed; maximum 2% total other crop seed; maximum 144 restricted noxious weed seed per pound. Seed less than 76% pure live seed will not be approved.

Common or Sweet Sundangrass

Minimum 76% pure live seed; maximum 1% total weed seed; maximum 2% total other crop seed; maximum 144 restricted noxious weed seed per pound. Seed less than 74% pure live seed will not be approved.

Rye (grain; all varieties)  
Kentucky Bluegrass (all approved varieties)  
Hard Fescue (all approved varieties)  
Shrub (bicolor) Lespedeza

Minimum 70% pure live seed; maximum 1% total weed seed; maximum 2% total other crop seed; maximum 144 noxious weed seed per pound. Seed less than 70% pure live seed will not be approved.

Centipedegrass  
Crownvetch  
Pensacola Bahiagrass  
Creeping Red Fescue

Japanese Millet  
Reed Canary Grass  
Zoysia

Minimum 70% pure live seed; maximum 1% total weed seed; maximum 2% total other crop seed; maximum 5% inert matter; maximum 144 restricted noxious weed seed per pound.

Barnyard Grass  
Big Bluestem  
Little Bluestem  
Bristly Locust  
Birdsfoot Trefoil  
Indiangrass  
Orchardgrass  
Switchgrass  
Yellow Blossom Sweet Clover

**STANDARD SPECIAL PROVISION****ERRATA**

(1-17-12) (Rev. 04-21-15)

Z-4

Revise the 2012 *Standard Specifications* as follows:

**Division 2**

**Page 2-7, line 31, Article 215-2 Construction Methods**, replace “Article 107-26” with “Article 107-25”.

**Page 2-17, Article 226-3, Measurement and Payment, line 2**, delete “pipe culverts,”.

**Page 2-20, Subarticle 230-4(B), Contractor Furnished Sources, change references as follows:** **Line 1**, replace “(4) Buffer Zone” with “(c) Buffer Zone”; **Line 12**, replace “(5) Evaluation for Potential Wetlands and Endangered Species” with “(d) Evaluation for Potential Wetlands and Endangered Species”; and **Line 33**, replace “(6) Approval” with “(4) Approval”.

**Division 3**

**Page 3-1, after line 15, Article 300-2 Materials**, replace “1032-9(F)” with “1032-6(F)”.

**Division 4**

**Page 4-77, line 27, Subarticle 452-3(C) Concrete Coping**, replace “sheet pile” with “reinforcement”.

**Division 6**

**Page 6-7, line 31, Article 609-3 Field Verification of Mixture and Job Mix Formula Adjustments**, replace “30” with “45”.

**Page 6-10, line 42, Subarticle 609-6(C)(2)**, replace “Subarticle 609-6(E)” with “Subarticle 609-6(D)”.

**Page 6-11, Table 609-1 Control Limits**, replace “Max. Spec. Limit” for the Target Source of  $P_{0.075}/P_{be}$  Ratio with “1.0”.

**Page 6-40, Article 650-2 Materials**, replace “Subarticle 1012-1(F)” with “Subarticle 1012-1(E)”

**Division 7**

**Page 7-1, Article 700-3, CONCRETE HAULING EQUIPMENT**, line 33, replace “competition” with “completion”.

**Division 8**

**Page 8-23, line 10, Article 838-2 Materials**, replace “Portland Cement Concrete, Class B” with “Portland Cement Concrete, Class A”.

**Division 10**

**Page 10-166, Article 1081-3 Hot Bitumen**, replace “Table 1081-16” with “Table 1081-2”, replace “Table 1081-17” with “Table 1081-3”, and replace “Table 1081-18” with “Table 1081-4”.

**Division 12**

**Page 12-7, Table 1205-3**, add “FOR THERMOPLASTIC” to the end of the title.

**Page 12-8, Subarticle 1205-5(B), line 13**, replace “Table 1205-2” with “Table 1205-4”.

**Page 12-8, Table 1205-4 and 1205-5**, replace “THERMOPLASTIC” in the title of these tables with “POLYUREA”.

**Page 12-9, Subarticle 1205-6(B), line 21**, replace “Table 1205-4” with “Table 1205-6”.

**Page 12-11, Subarticle 1205-8(C), line 25**, replace “Table 1205-5” with “Table 1205-7”.

**Division 15**

**Page 15-4, Subarticle 1505-3(F) Backfilling, line 26**, replace “Subarticle 235-4(C)” with “Subarticle 235-3(C)”.

**Page 15-6, Subarticle 1510-3(B), after line 21**, replace the allowable leakage formula with the following:  $W=LD\sqrt{P} \div 148,000$

**Page 15-6, Subarticle 1510-3(B), line 32**, delete “may be performed concurrently or” and replace with “shall be performed”.

**Page 15-17, Subarticle 1540-3(E), line 27**, delete “Type 1”.

**Division 17**

**Page 17-26, line 42, Subarticle 1731-3(D) Termination and Splicing within Interconnect Center**, delete this subarticle.

Revise the *2012 Roadway Standard Drawings* as follows:

**1633.01 Sheet 1 of 1, English Standard Drawing for Matting Installation**, replace “1633.01” with “1631.01”.

**STANDARD SPECIAL PROVISION****PLANT AND PEST QUARANTINES****(Imported Fire Ant, Gypsy Moth, Witchweed, And Other Noxious Weeds)**

(3-18-03) (Rev. 10-15-13)

Z-04a

**Within Quarantined Area**

This project may be within a county regulated for plant and/or pests. If the project or any part of the Contractor's operations is located within a quarantined area, thoroughly clean all equipment prior to moving out of the quarantined area. Comply with federal/state regulations by obtaining a certificate or limited permit for any regulated article moving from the quarantined area.

**Originating in a Quarantined County**

Obtain a certificate or limited permit issued by the N.C. Department of Agriculture/United States Department of Agriculture. Have the certificate or limited permit accompany the article when it arrives at the project site.

**Contact**

Contact the N.C. Department of Agriculture/United States Department of Agriculture at 1-800-206-9333, 919-733-6932, or <http://www.ncagr.gov/plantind/> to determine those specific project sites located in the quarantined area or for any regulated article used on this project originating in a quarantined county.

**Regulated Articles Include**

1. Soil, sand, gravel, compost, peat, humus, muck, and decomposed manure, separately or with other articles. This includes movement of articles listed above that may be associated with cut/waste, ditch pulling, and shoulder cutting.
2. Plants with roots including grass sod.
3. Plant crowns and roots.
4. Bulbs, corms, rhizomes, and tubers of ornamental plants.
5. Hay, straw, fodder, and plant litter of any kind.
6. Clearing and grubbing debris.
7. Used agricultural cultivating and harvesting equipment.
8. Used earth-moving equipment.
9. Any other products, articles, or means of conveyance, of any character, if determined by an inspector to present a hazard of spreading imported fire ant, gypsy moth, witchweed or other noxious weeds.

**STANDARD SPECIAL PROVISION****AWARD OF CONTRACT**

(6-28-77)

Z-6

“The North Carolina Department of Transportation, in accordance with the provisions of *Title VI of the Civil Rights Act of 1964* (78 Stat. 252) and the Regulations of the Department of Transportation (*49 C.F.R., Part 21*), issued pursuant to such act, hereby notifies all bidders that it will affirmatively insure that the contract entered into pursuant to this advertisement will be awarded to the lowest responsible bidder without discrimination on the ground of race, color, or national origin”.



**STANDARD SPECIAL PROVISION****MINORITY AND FEMALE EMPLOYMENT REQUIREMENTS**

Z-7

**NOTICE OF REQUIREMENTS FOR AFFIRMATIVE ACTION TO ENSURE EQUAL EMPLOYMENT OPPORTUNITY (*EXECUTIVE NUMBER 11246*)**

1. The goals and timetables for minority and female participation, expressed in percentage terms for the Contractor's aggregate workforce in each trade on all construction work in the covered area, see as shown on the attached sheet entitled "Employment Goals for Minority and Female participation".

These goals are applicable to all the Contractor's construction work (whether or not it is Federal or federally assisted) performed in the covered area. If the Contractor performs construction work in a geographical area located outside of the covered area, it shall apply the goals established for such geographical area where the work is actually performed. With regard to this second area, the Contractor also is subject to the goals for both its federally involved and nonfederally involved construction.

The Contractor's compliance with the Executive Order and the regulations in *41 CFR Part 60-4* shall be based on its implementation of the Equal Opportunity Clause, specific affirmative action obligations required by the specifications set forth in *41 CFR 60-4.3(a)*, and its effort to meet the goals. The hours of minority and female employment and training must be substantially uniform throughout the length of the contract, and in each trade and the Contractor shall make a good faith effort to employ minorities and women evenly on each of its projects. The transfer of minority or female employees or trainees from Contractor to Contractor or from project to project or the sole purpose of meeting the Contractor's goals shall be a violation of the contract, the executive Order and the regulations in *41 CFR Part 60-4*. Compliance with the goals will be measured against the total work hours performed.

2. As used in this Notice and in the contract resulting from this solicitation, the "covered area" is the county or counties shown on the cover sheet of the proposal form and contract.

**EMPLOYMENT GOALS FOR MINORITY  
AND FEMALE PARTICIPATION**

Economic Areas

**Area 023 29.7%**

Bertie County  
Camden County  
Chowan County  
Gates County  
Hertford County  
Pasquotank County  
Perquimans County

**Area 024 31.7%**

Beaufort County  
Carteret County  
Craven County  
Dare County  
Edgecombe County  
Green County  
Halifax County  
Hyde County  
Jones County  
Lenoir County  
Martin County  
Nash County  
Northampton County  
Pamlico County  
Pitt County  
Tyrrell County  
Washington County  
Wayne County  
Wilson County

**Area 025 23.5%**

Columbus County  
Duplin County  
Onslow County  
Pender County

**Area 026 33.5%**

Bladen County  
Hoke County  
Richmond County  
Robeson County  
Sampson County  
Scotland County

**Area 027 24.7%**

Chatham County  
Franklin County  
Granville County  
Harnett County  
Johnston County  
Lee County  
Person County  
Vance County  
Warren County

**Area 028 15.5%**

Alleghany County  
Ashe County  
Caswell County  
Davie County  
Montgomery County  
Moore County  
Rockingham County  
Surry County  
Watauga County  
Wilkes County

**Area 029 15.7%**

Alexander County  
Anson County  
Burke County  
Cabarrus County  
Caldwell County  
Catawba County  
Cleveland County  
Iredell County  
Lincoln County  
Polk County  
Rowan County  
Rutherford County  
Stanly County

**Area 0480 8.5%**

Buncombe County  
Madison County

**Area 030 6.3%**

Avery County  
Cherokee County  
Clay County  
Graham County  
Haywood County  
Henderson County  
Jackson County  
McDowell County  
Macon County  
Mitchell County  
Swain County  
Transylvania County  
Yancey County

SMSA Areas

Area 5720 26.6%

Currituck County

Area 9200 20.7%

Brunswick County

New Hanover County

Area 2560 24.2%

Cumberland County

Area 6640 22.8%

Durham County

Orange County

Wake County

Area 1300 16.2%

Alamance County

Area 3120 16.4%

Davidson County

Forsyth County

Guilford County

Randolph County

Stokes County

Yadkin County

Area 1520 18.3%

Gaston County

Mecklenburg County

Union County

---

Goals for Female

Participation in Each Trade

(Statewide) 6.9%

**STANDARD SPECIAL PROVISION****REQUIRED CONTRACT PROVISIONS FEDERAL - AID CONSTRUCTION CONTRACTS**

FHWA - 1273 Electronic Version - May 1, 2012

Z-8

- I. General
- II. Nondiscrimination
- III. Nonsegregated Facilities
- IV. Davis-Bacon and Related Act Provisions
- V. Contract Work Hours and Safety Standards Act Provisions
- VI. Subletting or Assigning the Contract
- VII. Safety: Accident Prevention
- VIII. False Statements Concerning Highway Projects
- IX. Implementation of Clean Air Act and Federal Water Pollution Control Act
- X. Compliance with Governmentwide Suspension and Debarment Requirements
- XI. Certification Regarding Use of Contract Funds for Lobbying

**ATTACHMENTS**

- A. Employment and Materials Preference for Appalachian Development Highway System or Appalachian Local Access Road Contracts (included in Appalachian contracts only)

**I. GENERAL**

1. Form FHWA-1273 must be physically incorporated in each construction contract funded under Title 23 (excluding emergency contracts solely intended for debris removal). The contractor (or subcontractor) must insert this form in each subcontract and further require its inclusion in all lower tier subcontracts (excluding purchase orders, rental agreements and other agreements for supplies or services).  
The applicable requirements of Form FHWA-1273 are incorporated by reference for work done under any purchase order, rental agreement or agreement for other services. The prime contractor shall be responsible for compliance by any subcontractor, lower-tier subcontractor or service provider.  
Form FHWA-1273 must be included in all Federal-aid design-build contracts, in all subcontracts and in lower tier subcontracts (excluding subcontracts for design services, purchase orders, rental agreements and other agreements for supplies or services). The design-builder shall be responsible for compliance by any subcontractor, lower-tier subcontractor or service provider.  
Contracting agencies may reference Form FHWA-1273 in bid proposal or request for proposal documents, however, the Form FHWA-1273 must be physically incorporated (not referenced) in all contracts, subcontracts and lower-tier subcontracts (excluding purchase orders, rental agreements and other agreements for supplies or services related to a construction contract).
2. Subject to the applicability criteria noted in the following sections, these contract provisions shall apply to all work performed on the contract by the contractor's own organization and with the assistance of workers under the contractor's immediate superintendence and to all work performed on the contract by piecework, station work, or by subcontract.
3. A breach of any of the stipulations contained in these Required Contract Provisions may be sufficient grounds for withholding of progress payments, withholding of final payment, termination of the contract, suspension / debarment or any other action determined to be appropriate by the contracting agency and FHWA.
4. Selection of Labor: During the performance of this contract, the contractor shall not use convict labor for any purpose within the limits of a construction project on a Federal-aid highway unless it is labor performed by convicts who are on parole, supervised release, or probation. The term Federal-aid highway does not include roadways functionally classified as local roads or rural minor collectors.

**II. NONDISCRIMINATION**

The provisions of this section related to 23 CFR Part 230 are applicable to all Federal-aid construction contracts and to all related construction subcontracts of \$10,000 or more. The provisions of 23 CFR Part 230 are not applicable to material supply, engineering, or architectural service contracts.

In addition, the contractor and all subcontractors must comply with the following policies: Executive Order 11246, 41 CFR 60, 29 CFR 1625-1627, Title 23 USC Section 140, the Rehabilitation Act of 1973, as amended (29 USC 794), Title VI of the Civil Rights Act of 1964, as amended, and related regulations including 49 CFR Parts 21, 26 and 27; and 23 CFR Parts 200, 230, and 633.

The contractor and all subcontractors must comply with: the requirements of the Equal Opportunity Clause in 41 CFR 60-1.4(b) and, for all construction contracts exceeding \$10,000, the Standard Federal Equal Employment Opportunity Construction Contract Specifications in 41 CFR 60-4.3.

Note: The U.S. Department of Labor has exclusive authority to determine compliance with Executive Order 11246 and the policies of the Secretary of Labor including 41 CFR 60, and 29 CFR 1625-1627. The contracting agency and the FHWA have the authority and the responsibility to ensure compliance with Title 23 USC Section 140, the Rehabilitation Act of 1973, as amended (29 USC 794), and Title VI of the Civil Rights Act of 1964, as amended, and related regulations including 49 CFR Parts 21, 26 and 27; and 23 CFR Parts 200, 230, and 633.

The following provision is adopted from 23 CFR 230, Appendix A, with appropriate revisions to conform to the U.S. Department of Labor (US DOL) and FHWA requirements.

1. **Equal Employment Opportunity:** Equal employment opportunity (EEO) requirements not to discriminate and to take affirmative action to assure equal opportunity as set forth under laws, executive orders, rules, regulations (28 CFR 35, 29 CFR 1630, 29 CFR 1625-1627, 41 CFR 60 and 49 CFR 27) and orders of the Secretary of Labor as modified by the provisions prescribed herein, and imposed pursuant to 23 U.S.C. 140 shall constitute the EEO and specific affirmative action standards for the contractor's project activities under this contract. The provisions of the Americans with Disabilities Act of 1990 (42 U.S.C. 12101 et seq.) set forth under 28 CFR 35 and 29 CFR 1630 are

incorporated by reference in this contract. In the execution of this contract, the contractor agrees to comply with the following minimum specific requirement activities of EEO:

- a. The contractor will work with the contracting agency and the Federal Government to ensure that it has made every good faith effort to provide equal opportunity with respect to all of its terms and conditions of employment and in their review of activities under the contract.
  - b. The contractor will accept as its operating policy the following statement:  
"It is the policy of this Company to assure that applicants are employed, and that employees are treated during employment, without regard to their race, religion, sex, color, national origin, age or disability. Such action shall include: employment, upgrading, demotion, or transfer; recruitment or recruitment advertising; layoff or termination; rates of pay or other forms of compensation; and selection for training, including apprenticeship, pre-apprenticeship, and/or on-the-job training."
2. **EEO Officer:** The contractor will designate and make known to the contracting officers an EEO Officer who will have the responsibility for and must be capable of effectively administering and promoting an active EEO program and who must be assigned adequate authority and responsibility to do so.
  3. **Dissemination of Policy:** All members of the contractor's staff who are authorized to hire, supervise, promote, and discharge employees, or who recommend such action, or who are substantially involved in such action, will be made fully cognizant of, and will implement, the contractor's EEO policy and contractual responsibilities to provide EEO in each grade and classification of employment. To ensure that the above agreement will be met, the following actions will be taken as a minimum:
    - a. Periodic meetings of supervisory and personnel office employees will be conducted before the start of work and then not less often than once every six months, at which time the contractor's EEO policy and its implementation will be reviewed and explained. The meetings will be conducted by the EEO Officer.
    - b. All new supervisory or personnel office employees will be given a thorough indoctrination by the EEO Officer, covering all major aspects of the contractor's EEO obligations within thirty days following their reporting for duty with the contractor.
    - c. All personnel who are engaged in direct recruitment for the project will be instructed by the EEO Officer in the contractor's procedures for locating and hiring minorities and women.
    - d. Notices and posters setting forth the contractor's EEO policy will be placed in areas readily accessible to employees, applicants for employment and potential employees.
    - e. The contractor's EEO policy and the procedures to implement such policy will be brought to the attention of employees by means of meetings, employee handbooks, or other appropriate means.
  4. **Recruitment:** When advertising for employees, the contractor will include in all advertisements for employees the notation: "An Equal Opportunity Employer." All such advertisements will be placed in publications having a large circulation among minorities and women in the area from which the project work force would normally be derived.
    - a. The contractor will, unless precluded by a valid bargaining agreement, conduct systematic and direct recruitment through public and private employee referral sources likely to yield qualified minorities and women. To meet this requirement, the contractor will identify sources of potential minority group employees, and establish with such identified sources procedures whereby minority and women applicants may be referred to the contractor for employment consideration.
    - b. In the event the contractor has a valid bargaining agreement providing for exclusive hiring hall referrals, the contractor is expected to observe the provisions of that agreement to the extent that the system meets the contractor's compliance with EEO contract provisions. Where implementation of such an agreement has the effect of discriminating against minorities or women, or obligates the contractor to do the same, such implementation violates Federal nondiscrimination provisions.
    - c. The contractor will encourage its present employees to refer minorities and women as applicants for employment. Information and procedures with regard to referring such applicants will be discussed with employees.
  5. **Personnel Actions:** Wages, working conditions, and employee benefits shall be established and administered, and personnel actions of every type, including hiring, upgrading, promotion, transfer, demotion, layoff, and termination, shall be taken without regard to race, color, religion, sex, national origin, age or disability. The following procedures shall be followed:
    - a. The contractor will conduct periodic inspections of project sites to insure that working conditions and employee facilities do not indicate discriminatory treatment of project site personnel.
    - b. The contractor will periodically evaluate the spread of wages paid within each classification to determine any evidence of discriminatory wage practices.
    - c. The contractor will periodically review selected personnel actions in depth to determine whether there is evidence of discrimination. Where evidence is found, the contractor will promptly take corrective action. If the review indicates that the discrimination may extend beyond the actions reviewed, such corrective action shall include all affected persons.
    - d. The contractor will promptly investigate all complaints of alleged discrimination made to the contractor in connection with its obligations under this contract, will attempt to resolve such complaints, and will take appropriate corrective action within a reasonable time. If the investigation indicates that the discrimination may affect persons other than the complainant, such corrective action shall include such other persons. Upon completion of each investigation, the contractor will inform every complainant of all of their avenues of appeal.
  6. **Training and Promotion:**
    - a. The contractor will assist in locating, qualifying, and increasing the skills of minorities and women who are applicants for employment or current employees. Such efforts should be aimed at developing full journey level status employees in the type of trade or job classification involved.
    - b. Consistent with the contractor's work force requirements and as permissible under Federal and State regulations, the contractor shall make full use of training programs, i.e., apprenticeship, and on-the-job training programs for the geographical area of contract performance. In the event a special provision for training is provided under this contract, this subparagraph will be superseded as indicated in the special provision. The contracting agency may reserve training positions for persons who receive welfare assistance in accordance with 23 U.S.C. 140(a).
    - c. The contractor will advise employees and applicants for employment of available training programs and entrance requirements for each.
    - d. The contractor will periodically review the training and promotion potential of employees who are minorities and women and will encourage eligible employees to apply for such training and promotion.

7. **Unions:** If the contractor relies in whole or in part upon unions as a source of employees, the contractor will use good faith efforts to obtain the cooperation of such unions to increase opportunities for minorities and women. Actions by the contractor, either directly or through a contractor's association acting as agent, will include the procedures set forth below:
  - a. The contractor will use good faith efforts to develop, in cooperation with the unions, joint training programs aimed toward qualifying more minorities and women for membership in the unions and increasing the skills of minorities and women so that they may qualify for higher paying employment.
  - b. The contractor will use good faith efforts to incorporate an EEO clause into each union agreement to the end that such union will be contractually bound to refer applicants without regard to their race, color, religion, sex, national origin, age or disability.
  - c. The contractor is to obtain information as to the referral practices and policies of the labor union except that to the extent such information is within the exclusive possession of the labor union and such labor union refuses to furnish such information to the contractor, the contractor shall so certify to the contracting agency and shall set forth what efforts have been made to obtain such information.
  - d. In the event the union is unable to provide the contractor with a reasonable flow of referrals within the time limit set forth in the collective bargaining agreement, the contractor will, through independent recruitment efforts, fill the employment vacancies without regard to race, color, religion, sex, national origin, age or disability; making full efforts to obtain qualified and/or qualifiable minorities and women. The failure of a union to provide sufficient referrals (even though it is obligated to provide exclusive referrals under the terms of a collective bargaining agreement) does not relieve the contractor from the requirements of this paragraph. In the event the union referral practice prevents the contractor from meeting the obligations pursuant to Executive Order 11246, as amended, and these special provisions, such contractor shall immediately notify the contracting agency.
8. **Reasonable Accommodation for Applicants / Employees with Disabilities:** The contractor must be familiar with the requirements for and comply with the Americans with Disabilities Act and all rules and regulations established there under. Employers must provide reasonable accommodation in all employment activities unless to do so would cause an undue hardship.
9. **Selection of Subcontractors, Procurement of Materials and Leasing of Equipment:** The contractor shall not discriminate on the grounds of race, color, religion, sex, national origin, age or disability in the selection and retention of subcontractors, including procurement of materials and leases of equipment. The contractor shall take all necessary and reasonable steps to ensure nondiscrimination in the administration of this contract.
  - a. The contractor shall notify all potential subcontractors and suppliers and lessors of their EEO obligations under this contract.
  - b. The contractor will use good faith efforts to ensure subcontractor compliance with their EEO obligations.
10. **Assurance Required by 49 CFR 26.13(b):**
  - a. The requirements of 49 CFR Part 26 and the State DOT's U.S. DOT-approved DBE program are incorporated by reference.
  - b. The contractor or subcontractor shall not discriminate on the basis of race, color, national origin, or sex in the performance of this contract. The contractor shall carry out applicable requirements of 49 CFR Part 26 in the award and administration of DOT-assisted contracts. Failure by the contractor to carry out these requirements is a material breach of this contract, which may result in the termination of this contract or such other remedy as the contracting agency deems appropriate.
11. **Records and Reports:** The contractor shall keep such records as necessary to document compliance with the EEO requirements. Such records shall be retained for a period of three years following the date of the final payment to the contractor for all contract work and shall be available at reasonable times and places for inspection by authorized representatives of the contracting agency and the FHWA.
  - a. The records kept by the contractor shall document the following:
    - (1) The number and work hours of minority and non-minority group members and women employed in each work classification on the project;
    - (2) The progress and efforts being made in cooperation with unions, when applicable, to increase employment opportunities for minorities and women; and
    - (3) The progress and efforts being made in locating, hiring, training, qualifying, and upgrading minorities and women;
  - b. The contractors and subcontractors will submit an annual report to the contracting agency each July for the duration of the project, indicating the number of minority, women, and non-minority group employees currently engaged in each work classification required by the contract work. This information is to be reported on Form FHWA-1391. The staffing data should represent the project work force on board in all or any part of the last payroll period preceding the end of July. If on-the-job training is being required by special provision, the contractor will be required to collect and report training data. The employment data should reflect the work force on board during all or any part of the last payroll period preceding the end of July.

### III. NONSEGREGATED FACILITIES

This provision is applicable to all Federal-aid construction contracts and to all related construction subcontracts of \$10,000 or more.

The contractor must ensure that facilities provided for employees are provided in such a manner that segregation on the basis of race, color, religion, sex, or national origin cannot result. The contractor may neither require such segregated use by written or oral policies nor tolerate such use by employee custom. The contractor's obligation extends further to ensure that its employees are not assigned to perform their services at any location, under the contractor's control, where the facilities are segregated. The term "facilities" includes waiting rooms, work areas, restaurants and other eating areas, time clocks, restrooms, washrooms, locker rooms, and other storage or dressing areas, parking lots, drinking fountains, recreation or entertainment areas, transportation, and housing provided for employees. The contractor shall provide separate or single-user restrooms and necessary dressing or sleeping areas to assure privacy between sexes.

### IV. DAVIS-BACON AND RELATED ACT PROVISIONS

This section is applicable to all Federal-aid construction projects exceeding \$2,000 and to all related subcontracts and lower-tier subcontracts (regardless of subcontract size). The requirements apply to all projects located within the right-of-way of a roadway that is functionally classified as Federal-aid highway. This excludes roadways functionally classified as local roads or rural minor collectors, which are exempt. Contracting agencies may elect to apply these requirements to other projects.

The following provisions are from the U.S. Department of Labor regulations in 29 CFR 5.5 "Contract provisions and related matters" with minor revisions to conform to the FHWA-1273 format and FHWA program requirements.

#### 1. Minimum wages

- a. All laborers and mechanics employed or working upon the site of the work, will be paid unconditionally and not less often than once a week, and without subsequent deduction or rebate on any account (except such payroll deductions as are permitted by regulations issued by the

Secretary of Labor under the Copeland Act (29 CFR part 3)), the full amount of wages and bona fide fringe benefits (or cash equivalents thereof) due at time of payment computed at rates not less than those contained in the wage determination of the Secretary of Labor which is attached hereto and made a part hereof, regardless of any contractual relationship which may be alleged to exist between the contractor and such laborers and mechanics.

Contributions made or costs reasonably anticipated for bona fide fringe benefits under section 1(b)(2) of the Davis-Bacon Act on behalf of laborers or mechanics are considered wages paid to such laborers or mechanics, subject to the provisions of paragraph 1.d. of this section; also, regular contributions made or costs incurred for more than a weekly period (but not less often than quarterly) under plans, funds, or programs which cover the particular weekly period, are deemed to be constructively made or incurred during such weekly period. Such laborers and mechanics shall be paid the appropriate wage rate and fringe benefits on the wage determination for the classification of work actually performed, without regard to skill, except as provided in 29 CFR 5.5(a)(4). Laborers or mechanics performing work in more than one classification may be compensated at the rate specified for each classification for the time actually worked therein: Provided, That the employer's payroll records accurately set forth the time spent in each classification in which work is performed. The wage determination (including any additional classification and wage rates conformed under paragraph 1.b. of this section) and the Davis-Bacon poster (WH-1321) shall be posted at all times by the contractor and its subcontractors at the site of the work in a prominent and accessible place where it can be easily seen by the workers.

- b. (1) The contracting officer shall require that any class of laborers or mechanics, including helpers, which is not listed in the wage determination and which is to be employed under the contract shall be classified in conformance with the wage determination. The contracting officer shall approve an additional classification and wage rate and fringe benefits therefore only when the following criteria have been met:
    - (i) The work to be performed by the classification requested is not performed by a classification in the wage determination; and
    - (ii) The classification is utilized in the area by the construction industry; and
    - (iii) The proposed wage rate, including any bona fide fringe benefits, bears a reasonable relationship to the wage rates contained in the wage determination.
  - (2) If the contractor and the laborers and mechanics to be employed in the classification (if known), or their representatives, and the contracting officer agree on the classification and wage rate (including the amount designated for fringe benefits where appropriate), a report of the action taken shall be sent by the contracting officer to the Administrator of the Wage and Hour Division, Employment Standards Administration, U.S. Department of Labor, Washington, DC 20210. The Administrator, or an authorized representative, will approve, modify, or disapprove every additional classification action within 30 days of receipt and so advise the contracting officer or will notify the contracting officer within the 30-day period that additional time is necessary.
  - (3) In the event the contractor, the laborers or mechanics to be employed in the classification or their representatives, and the contracting officer do not agree on the proposed classification and wage rate (including the amount designated for fringe benefits, where appropriate), the contracting officer shall refer the questions, including the views of all interested parties and the recommendation of the contracting officer, to the Wage and Hour Administrator for determination. The Wage and Hour Administrator, or an authorized representative, will issue a determination within 30 days of receipt and so advise the contracting officer or will notify the contracting officer within the 30-day period that additional time is necessary.
  - (4) The wage rate (including fringe benefits where appropriate) determined pursuant to paragraphs 1.b.(2) or 1.b.(3) of this section, shall be paid to all workers performing work in the classification under this contract from the first day on which work is performed in the classification.
  - c. Whenever the minimum wage rate prescribed in the contract for a class of laborers or mechanics includes a fringe benefit which is not expressed as an hourly rate, the contractor shall either pay the benefit as stated in the wage determination or shall pay another bona fide fringe benefit or an hourly cash equivalent thereof.
  - d. If the contractor does not make payments to a trustee or other third person, the contractor may consider as part of the wages of any laborer or mechanic the amount of any costs reasonably anticipated in providing bona fide fringe benefits under a plan or program, Provided, That the Secretary of Labor has found, upon the written request of the contractor, that the applicable standards of the Davis-Bacon Act have been met. The Secretary of Labor may require the contractor to set aside in a separate account assets for the meeting of obligations under the plan or program.
2. **Withholding.** The contracting agency shall upon its own action or upon written request of an authorized representative of the Department of Labor, withhold or cause to be withheld from the contractor under this contract, or any other Federal contract with the same prime contractor, or any other federally-assisted contract subject to Davis-Bacon prevailing wage requirements, which is held by the same prime contractor, so much of the accrued payments or advances as may be considered necessary to pay laborers and mechanics, including apprentices, trainees, and helpers, employed by the contractor or any subcontractor the full amount of wages required by the contract. In the event of failure to pay any laborer or mechanic, including any apprentice, trainee, or helper, employed or working on the site of the work, all or part of the wages required by the contract, the contracting agency may, after written notice to the contractor, take such action as may be necessary to cause the suspension of any further payment, advance, or guarantee of funds until such violations have ceased.
3. **Payrolls and basic records**
- a. Payrolls and basic records relating thereto shall be maintained by the contractor during the course of the work and preserved for a period of three years thereafter for all laborers and mechanics working at the site of the work. Such records shall contain the name, address, and social security number of each such worker, his or her correct classification, hourly rates of wages paid (including rates of contributions or costs anticipated for bona fide fringe benefits or cash equivalents thereof of the types described in section 1(b)(2)(B) of the Davis-Bacon Act), daily and weekly number of hours worked, deductions made and actual wages paid. Whenever the Secretary of Labor has found under 29 CFR 5.5(a)(1)(iv) that the wages of any laborer or mechanic include the amount of any costs reasonably anticipated in providing benefits under a plan or program described in section 1(b)(2)(B) of the Davis-Bacon Act, the contractor shall maintain records which show that the commitment to provide such benefits is enforceable, that the plan or program is financially responsible, and that the plan or program has been communicated in writing to the laborers or mechanics affected, and records which show the costs anticipated or the actual cost incurred in providing such benefits. Contractors employing apprentices or trainees under approved programs shall maintain written evidence of the registration of apprenticeship programs and certification of trainee programs, the registration of the apprentices and trainees, and the ratios and wage rates prescribed in the applicable programs.
  - b. (1) The contractor shall submit weekly for each week in which any contract work is performed a copy of all payrolls to the contracting agency. The payrolls submitted shall set out accurately and completely all of the information required to be maintained under 29 CFR 5.5(a)(3)(i), except that full social security numbers and home addresses shall not be included on weekly transmittals. Instead the

payrolls shall only need to include an individually identifying number for each employee ( e.g. , the last four digits of the employee's social security number). The required weekly payroll information may be submitted in any form desired. Optional Form WH-347 is available for this purpose from the Wage and Hour Division Web site at <http://www.dol.gov/esa/whd/forms/wh347instr.htm> or its successor site. The prime contractor is responsible for the submission of copies of payrolls by all subcontractors. Contractors and subcontractors shall maintain the full social security number and current address of each covered worker, and shall provide them upon request to the contracting agency for transmission to the State DOT, the FHWA or the Wage and Hour Division of the Department of Labor for purposes of an investigation or audit of compliance with prevailing wage requirements. It is not a violation of this section for a prime contractor to require a subcontractor to provide addresses and social security numbers to the prime contractor for its own records, without weekly submission to the contracting agency.

- (2) Each payroll submitted shall be accompanied by a "Statement of Compliance," signed by the contractor or subcontractor or his or her agent who pays or supervises the payment of the persons employed under the contract and shall certify the following:
- (i) That the payroll for the payroll period contains the information required to be provided under §5.5 (a)(3)(ii) of Regulations, 29 CFR part 5, the appropriate information is being maintained under §5.5 (a)(3)(i) of Regulations, 29 CFR part 5, and that such information is correct and complete;
  - (ii) That each laborer or mechanic (including each helper, apprentice, and trainee) employed on the contract during the payroll period has been paid the full weekly wages earned, without rebate, either directly or indirectly, and that no deductions have been made either directly or indirectly from the full wages earned, other than permissible deductions as set forth in Regulations, 29 CFR part 3;
  - (iii) That each laborer or mechanic has been paid not less than the applicable wage rates and fringe benefits or cash equivalents for the classification of work performed, as specified in the applicable wage determination incorporated into the contract.
- (3) The weekly submission of a properly executed certification set forth on the reverse side of Optional Form WH-347 shall satisfy the requirement for submission of the "Statement of Compliance" required by paragraph 3.b.(2) of this section.
- (4) The falsification of any of the above certifications may subject the contractor or subcontractor to civil or criminal prosecution under section 1001 of title 18 and section 231 of title 31 of the United States Code.
- c. The contractor or subcontractor shall make the records required under paragraph 3.a. of this section available for inspection, copying, or transcription by authorized representatives of the contracting agency, the State DOT, the FHWA, or the Department of Labor, and shall permit such representatives to interview employees during working hours on the job. If the contractor or subcontractor fails to submit the required records or to make them available, the FHWA may, after written notice to the contractor, the contracting agency or the State DOT, take such action as may be necessary to cause the suspension of any further payment, advance, or guarantee of funds. Furthermore, failure to submit the required records upon request or to make such records available may be grounds for debarment action pursuant to 29 CFR 5.12.
- 4. Apprentices and trainees**
- a. Apprentices (programs of the USDOL). Apprentices will be permitted to work at less than the predetermined rate for the work they performed when they are employed pursuant to and individually registered in a bona fide apprenticeship program registered with the U.S. Department of Labor, Employment and Training Administration, Office of Apprenticeship Training, Employer and Labor Services, or with a State Apprenticeship Agency recognized by the Office, or if a person is employed in his or her first 90 days of probationary employment as an apprentice in such an apprenticeship program, who is not individually registered in the program, but who has been certified by the Office of Apprenticeship Training, Employer and Labor Services or a State Apprenticeship Agency (where appropriate) to be eligible for probationary employment as an apprentice.
- The allowable ratio of apprentices to journeymen on the job site in any craft classification shall not be greater than the ratio permitted to the contractor as to the entire work force under the registered program. Any worker listed on a payroll at an apprentice wage rate, who is not registered or otherwise employed as stated above, shall be paid not less than the applicable wage rate on the wage determination for the classification of work actually performed. In addition, any apprentice performing work on the job site in excess of the ratio permitted under the registered program shall be paid not less than the applicable wage rate on the wage determination for the work actually performed. Where a contractor is performing construction on a project in a locality other than that in which its program is registered, the ratios and wage rates (expressed in percentages of the journeyman's hourly rate) specified in the contractor's or subcontractor's registered program shall be observed.
- Every apprentice must be paid at not less than the rate specified in the registered program for the apprentice's level of progress, expressed as a percentage of the journeymen hourly rate specified in the applicable wage determination. Apprentices shall be paid fringe benefits in accordance with the provisions of the apprenticeship program. If the apprenticeship program does not specify fringe benefits, apprentices must be paid the full amount of fringe benefits listed on the wage determination for the applicable classification. If the Administrator determines that a different practice prevails for the applicable apprentice classification, fringes shall be paid in accordance with that determination.
- In the event the Office of Apprenticeship Training, Employer and Labor Services, or a State Apprenticeship Agency recognized by the Office, withdraws approval of an apprenticeship program, the contractor will no longer be permitted to utilize apprentices at less than the applicable predetermined rate for the work performed until an acceptable program is approved.
- b. Trainees (programs of the USDOL). Except as provided in 29 CFR 5.16, trainees will not be permitted to work at less than the predetermined rate for the work performed unless they are employed pursuant to and individually registered in a program which has received prior approval, evidenced by formal certification by the U.S. Department of Labor, Employment and Training Administration.
- The ratio of trainees to journeymen on the job site shall not be greater than permitted under the plan approved by the Employment and Training Administration.
- Every trainee must be paid at not less than the rate specified in the approved program for the trainee's level of progress, expressed as a percentage of the journeyman hourly rate specified in the applicable wage determination. Trainees shall be paid fringe benefits in accordance with the provisions of the trainee program. If the trainee program does not mention fringe benefits, trainees shall be paid the full amount of fringe benefits listed on the wage determination unless the Administrator of the Wage and Hour Division determines that there is an apprenticeship program associated with the corresponding journeyman wage rate on the wage determination which provides for less than full fringe benefits for apprentices. Any employee listed on the payroll at a trainee rate who is not registered and participating in a training plan approved by the Employment and Training Administration shall be paid not less than the applicable wage rate on the wage determination for the classification of work actually performed. In addition, any trainee performing work on the job site in excess of the ratio permitted under the registered program shall be paid not less than the applicable wage rate on the wage determination for the work actually performed.



- In the event the Employment and Training Administration withdraws approval of a training program, the contractor will no longer be permitted to utilize trainees at less than the applicable predetermined rate for the work performed until an acceptable program is approved.
- c. Equal employment opportunity. The utilization of apprentices, trainees and journeymen under this part shall be in conformity with the equal employment opportunity requirements of Executive Order 11246, as amended, and 29 CFR part 30.
  - d. Apprentices and Trainees (programs of the U.S. DOT). Apprentices and trainees working under apprenticeship and skill training programs which have been certified by the Secretary of Transportation as promoting EEO in connection with Federal-aid highway construction programs are not subject to the requirements of paragraph 4 of this Section IV. The straight time hourly wage rates for apprentices and trainees under such programs will be established by the particular programs. The ratio of apprentices and trainees to journeymen shall not be greater than permitted by the terms of the particular program.
5. **Compliance with Copeland Act requirements.** The contractor shall comply with the requirements of 29 CFR part 3, which are incorporated by reference in this contract.
  6. **Subcontracts.** The contractor or subcontractor shall insert Form FHWA-1273 in any subcontracts and also require the subcontractors to include Form FHWA-1273 in any lower tier subcontracts. The prime contractor shall be responsible for the compliance by any subcontractor or lower tier subcontractor with all the contract clauses in 29 CFR 5.5.
  7. **Contract termination:** debarment. A breach of the contract clauses in 29 CFR 5.5 may be grounds for termination of the contract, and for debarment as a contractor and a subcontractor as provided in 29 CFR 5.12.
  8. **Compliance with Davis-Bacon and Related Act requirements.** All rulings and interpretations of the Davis-Bacon and Related Acts contained in 29 CFR parts 1, 3, and 5 are herein incorporated by reference in this contract.
  9. **Disputes concerning labor standards.** Disputes arising out of the labor standards provisions of this contract shall not be subject to the general disputes clause of this contract. Such disputes shall be resolved in accordance with the procedures of the Department of Labor set forth in 29 CFR parts 5, 6, and 7. Disputes within the meaning of this clause include disputes between the contractor (or any of its subcontractors) and the contracting agency, the U.S. Department of Labor, or the employees or their representatives.
  10. **Certification of eligibility.**
    - a. By entering into this contract, the contractor certifies that neither it (nor he or she) nor any person or firm who has an interest in the contractor's firm is a person or firm ineligible to be awarded Government contracts by virtue of section 3(a) of the Davis-Bacon Act or 29 CFR 5.12(a)(1).
    - b. No part of this contract shall be subcontracted to any person or firm ineligible for award of a Government contract by virtue of section 3(a) of the Davis-Bacon Act or 29 CFR 5.12(a)(1).
    - c. The penalty for making false statements is prescribed in the U.S. Criminal Code, 18 U.S.C. 1001.

#### V. CONTRACT WORK HOURS AND SAFETY STANDARDS ACT

The following clauses apply to any Federal-aid construction contract in an amount in excess of \$100,000 and subject to the overtime provisions of the Contract Work Hours and Safety Standards Act. These clauses shall be inserted in addition to the clauses required by 29 CFR 5.5(a) or 29 CFR 4.6. As used in this paragraph, the terms laborers and mechanics include watchmen and guards.

1. **Overtime requirements.** No contractor or subcontractor contracting for any part of the contract work which may require or involve the employment of laborers or mechanics shall require or permit any such laborer or mechanic in any workweek in which he or she is employed on such work to work in excess of forty hours in such workweek unless such laborer or mechanic receives compensation at a rate not less than one and one-half times the basic rate of pay for all hours worked in excess of forty hours in such workweek.
2. **Violation; liability for unpaid wages; liquidated damages.** In the event of any violation of the clause set forth in paragraph (1.) of this section, the contractor and any subcontractor responsible therefor shall be liable for the unpaid wages. In addition, such contractor and subcontractor shall be liable to the United States (in the case of work done under contract for the District of Columbia or a territory, to such District or to such territory), for liquidated damages. Such liquidated damages shall be computed with respect to each individual laborer or mechanic, including watchmen and guards, employed in violation of the clause set forth in paragraph (1.) of this section, in the sum of \$10 for each calendar day on which such individual was required or permitted to work in excess of the standard workweek of forty hours without payment of the overtime wages required by the clause set forth in paragraph (1.) of this section.
3. **Withholding for unpaid wages and liquidated damages.** The FHWA or the contacting agency shall upon its own action or upon written request of an authorized representative of the Department of Labor withhold or cause to be withheld, from any moneys payable on account of work performed by the contractor or subcontractor under any such contract or any other Federal contract with the same prime contractor, or any other federally-assisted contract subject to the Contract Work Hours and Safety Standards Act, which is held by the same prime contractor, such sums as may be determined to be necessary to satisfy any liabilities of such contractor or subcontractor for unpaid wages and liquidated damages as provided in the clause set forth in paragraph (2.) of this section.
4. **Subcontracts.** The contractor or subcontractor shall insert in any subcontracts the clauses set forth in paragraph (1.) through (4.) of this section and also a clause requiring the subcontractors to include these clauses in any lower tier subcontracts. The prime contractor shall be responsible for compliance by any subcontractor or lower tier subcontractor with the clauses set forth in paragraphs (1.) through (4.) of this section.

#### VI. SUBLETTING OR ASSIGNING THE CONTRACT

This provision is applicable to all Federal-aid construction contracts on the National Highway System.

1. The contractor shall perform with its own organization contract work amounting to not less than 30 percent (or a greater percentage if specified elsewhere in the contract) of the total original contract price, excluding any specialty items designated by the contracting agency. Specialty items may be performed by subcontract and the amount of any such specialty items performed may be deducted from the total original contract price before computing the amount of work required to be performed by the contractor's own organization (23 CFR 635.116).
  - a. The term "perform work with its own organization" refers to workers employed or leased by the prime contractor, and equipment owned or rented by the prime contractor, with or without operators. Such term does not include employees or equipment of a subcontractor or lower tier subcontractor, agents of the prime contractor, or any other assignees. The term may include payments for the costs of hiring leased employees from an employee leasing firm meeting all relevant Federal and State regulatory requirements. Leased employees may only be included in this term if the prime contractor meets all of the following conditions:
    - (1) the prime contractor maintains control over the supervision of the day-to-day activities of the leased employees;

- (2) the prime contractor remains responsible for the quality of the work of the leased employees;
  - (3) the prime contractor retains all power to accept or exclude individual employees from work on the project; and
  - (4) the prime contractor remains ultimately responsible for the payment of predetermined minimum wages, the submission of payrolls, statements of compliance and all other Federal regulatory requirements.
- b. "Specialty Items" shall be construed to be limited to work that requires highly specialized knowledge, abilities, or equipment not ordinarily available in the type of contracting organizations qualified and expected to bid or propose on the contract as a whole and in general are to be limited to minor components of the overall contract.
2. The contract amount upon which the requirements set forth in paragraph (1) of Section VI is computed includes the cost of material and manufactured products which are to be purchased or produced by the contractor under the contract provisions.
  3. The contractor shall furnish (a) a competent superintendent or supervisor who is employed by the firm, has full authority to direct performance of the work in accordance with the contract requirements, and is in charge of all construction operations (regardless of who performs the work) and (b) such other of its own organizational resources (supervision, management, and engineering services) as the contracting officer determines is necessary to assure the performance of the contract.
  4. No portion of the contract shall be sublet, assigned or otherwise disposed of except with the written consent of the contracting officer, or authorized representative, and such consent when given shall not be construed to relieve the contractor of any responsibility for the fulfillment of the contract. Written consent will be given only after the contracting agency has assured that each subcontract is evidenced in writing and that it contains all pertinent provisions and requirements of the prime contract.
  5. The 30% self-performance requirement of paragraph (1) is not applicable to design-build contracts; however, contracting agencies may establish their own self-performance requirements.

#### **VII. SAFETY: ACCIDENT PREVENTION**

This provision is applicable to all Federal-aid construction contracts and to all related subcontracts.

1. In the performance of this contract the contractor shall comply with all applicable Federal, State, and local laws governing safety, health, and sanitation (23 CFR 635). The contractor shall provide all safeguards, safety devices and protective equipment and take any other needed actions as it determines, or as the contracting officer may determine, to be reasonably necessary to protect the life and health of employees on the job and the safety of the public and to protect property in connection with the performance of the work covered by the contract.
2. It is a condition of this contract, and shall be made a condition of each subcontract, which the contractor enters into pursuant to this contract, that the contractor and any subcontractor shall not permit any employee, in performance of the contract, to work in surroundings or under conditions which are unsanitary, hazardous or dangerous to his/her health or safety, as determined under construction safety and health standards (29 CFR 1926) promulgated by the Secretary of Labor, in accordance with Section 107 of the Contract Work Hours and Safety Standards Act (40 U.S.C. 3704).
3. Pursuant to 29 CFR 1926.3, it is a condition of this contract that the Secretary of Labor or authorized representative thereof, shall have right of entry to any site of contract performance to inspect or investigate the matter of compliance with the construction safety and health standards and to carry out the duties of the Secretary under Section 107 of the Contract Work Hours and Safety Standards Act (40 U.S.C.3704).

#### **VIII. FALSE STATEMENTS CONCERNING HIGHWAY PROJECTS**

This provision is applicable to all Federal-aid construction contracts and to all related subcontracts.

In order to assure high quality and durable construction in conformity with approved plans and specifications and a high degree of reliability on statements and representations made by engineers, contractors, suppliers, and workers on Federal-aid highway projects, it is essential that all persons concerned with the project perform their functions as carefully, thoroughly, and honestly as possible. Willful falsification, distortion, or misrepresentation with respect to any facts related to the project is a violation of Federal law. To prevent any misunderstanding regarding the seriousness of these and similar acts, Form FHWA-1022 shall be posted on each Federal-aid highway project (23 CFR 635) in one or more places where it is readily available to all persons concerned with the project:

18 U.S.C. 1020 reads as follows:

"Whoever, being an officer, agent, or employee of the United States, or of any State or Territory, or whoever, whether a person, association, firm, or corporation, knowingly makes any false statement, false representation, or false report as to the character, quality, quantity, or cost of the material used or to be used, or the quantity or quality of the work performed or to be performed, or the cost thereof in connection with the submission of plans, maps, specifications, contracts, or costs of construction on any highway or related project submitted for approval to the Secretary of Transportation; or

Whoever knowingly makes any false statement, false representation, false report or false claim with respect to the character, quality, quantity, or cost of any work performed or to be performed, or materials furnished or to be furnished, in connection with the construction of any highway or related project approved by the Secretary of Transportation; or

Whoever knowingly makes any false statement or false representation as to material fact in any statement, certificate, or report submitted pursuant to provisions of the Federal-aid Roads Act approved July 1, 1916, (39 Stat. 355), as amended and supplemented;

Shall be fined under this title or imprisoned not more than 5 years or both."

#### **IX. IMPLEMENTATION OF CLEAN AIR ACT AND FEDERAL WATER POLLUTION CONTROL ACT**

This provision is applicable to all Federal-aid construction contracts and to all related subcontracts.

By submission of this bid/proposal or the execution of this contract, or subcontract, as appropriate, the bidder, proposer, Federal-aid construction contractor, or subcontractor, as appropriate, will be deemed to have stipulated as follows:

1. That any person who is or will be utilized in the performance of this contract is not prohibited from receiving an award due to a violation of Section 508 of the Clean Water Act or Section 306 of the Clean Air Act.
2. That the contractor agrees to include or cause to be included the requirements of paragraph (1) of this Section X in every subcontract, and further agrees to take such action as the contracting agency may direct as a means of enforcing such requirements.

**X. CERTIFICATION REGARDING DEBARMENT, SUSPENSION, INELIGIBILITY AND VOLUNTARY EXCLUSION**

This provision is applicable to all Federal-aid construction contracts, design-build contracts, subcontracts, lower-tier subcontracts, purchase orders, lease agreements, consultant contracts or any other covered transaction requiring FHWA approval or that is estimated to cost \$25,000 or more – as defined in 2 CFR Parts 180 and 1200.

**1. Instructions for Certification – First Tier Participants:**

- a. By signing and submitting this proposal, the prospective first tier participant is providing the certification set out below.
- b. The inability of a person to provide the certification set out below will not necessarily result in denial of participation in this covered transaction. The prospective first tier participant shall submit an explanation of why it cannot provide the certification set out below. The certification or explanation will be considered in connection with the department or agency's determination whether to enter into this transaction. However, failure of the prospective first tier participant to furnish a certification or an explanation shall disqualify such a person from participation in this transaction.
- c. The certification in this clause is a material representation of fact upon which reliance was placed when the contracting agency determined to enter into this transaction. If it is later determined that the prospective participant knowingly rendered an erroneous certification, in addition to other remedies available to the Federal Government, the contracting agency may terminate this transaction for cause of default.
- d. The prospective first tier participant shall provide immediate written notice to the contracting agency to whom this proposal is submitted if any time the prospective first tier participant learns that its certification was erroneous when submitted or has become erroneous by reason of changed circumstances.
- e. The terms "covered transaction," "debarred," "suspended," "ineligible," "participant," "person," "principal," and "voluntarily excluded," as used in this clause, are defined in 2 CFR Parts 180 and 1200. "First Tier Covered Transactions" refers to any covered transaction between a grantee or subgrantee of Federal funds and a participant (such as the prime or general contract). "Lower Tier Covered Transactions" refers to any covered transaction under a First Tier Covered Transaction (such as subcontracts). "First Tier Participant" refers to the participant who has entered into a covered transaction with a grantee or subgrantee of Federal funds (such as the prime or general contractor). "Lower Tier Participant" refers any participant who has entered into a covered transaction with a First Tier Participant or other Lower Tier Participants (such as subcontractors and suppliers).
- f. The prospective first tier participant agrees by submitting this proposal that, should the proposed covered transaction be entered into, it shall not knowingly enter into any lower tier covered transaction with a person who is debarred, suspended, declared ineligible, or voluntarily excluded from participation in this covered transaction, unless authorized by the department or agency entering into this transaction.
- g. The prospective first tier participant further agrees by submitting this proposal that it will include the clause titled "Certification Regarding Debarment, Suspension, Ineligibility and Voluntary Exclusion-Lower Tier Covered Transactions," provided by the department or contracting agency, entering into this covered transaction, without modification, in all lower tier covered transactions and in all solicitations for lower tier covered transactions exceeding the \$25,000 threshold.
- h. A participant in a covered transaction may rely upon a certification of a prospective participant in a lower tier covered transaction that is not debarred, suspended, ineligible, or voluntarily excluded from the covered transaction, unless it knows that the certification is erroneous. A participant is responsible for ensuring that its principals are not suspended, debarred, or otherwise ineligible to participate in covered transactions. To verify the eligibility of its principals, as well as the eligibility of any lower tier prospective participants, each participant may, but is not required to, check the Excluded Parties List System website (<https://www.epls.gov/>), which is compiled by the General Services Administration.
- i. Nothing contained in the foregoing shall be construed to require the establishment of a system of records in order to render in good faith the certification required by this clause. The knowledge and information of the prospective participant is not required to exceed that which is normally possessed by a prudent person in the ordinary course of business dealings.
- j. Except for transactions authorized under paragraph (f) of these instructions, if a participant in a covered transaction knowingly enters into a lower tier covered transaction with a person who is suspended, debarred, ineligible, or voluntarily excluded from participation in this transaction, in addition to other remedies available to the Federal Government, the department or agency may terminate this transaction for cause or default.

\* \* \* \* \*

**2. Certification Regarding Debarment, Suspension, Ineligibility and Voluntary Exclusion – First Tier Participants:**

- a. The prospective first tier participant certifies to the best of its knowledge and belief, that it and its principals:
  - (1) Are not presently debarred, suspended, proposed for debarment, declared ineligible, or voluntarily excluded from participating in covered transactions by any Federal department or agency;
  - (2) Have not within a three-year period preceding this proposal been convicted of or had a civil judgment rendered against them for commission of fraud or a criminal offense in connection with obtaining, attempting to obtain, or performing a public (Federal, State or local) transaction or contract under a public transaction; violation of Federal or State antitrust statutes or commission of embezzlement, theft, forgery, bribery, falsification or destruction of records, making false statements, or receiving stolen property;
  - (3) Are not presently indicted for or otherwise criminally or civilly charged by a governmental entity (Federal, State or local) with commission of any of the offenses enumerated in paragraph (a)(2) of this certification; and
  - (4) Have not within a three-year period preceding this application/proposal had one or more public transactions (Federal, State or local) terminated for cause or default.
- b. Where the prospective participant is unable to certify to any of the statements in this certification, such prospective participant shall attach an explanation to this proposal.

**2. Instructions for Certification - Lower Tier Participants:**

(Applicable to all subcontracts, purchase orders and other lower tier transactions requiring prior FHWA approval or estimated to cost \$25,000 or more - 2 CFR Parts 180 and 1200)

- a. By signing and submitting this proposal, the prospective lower tier is providing the certification set out below.
- b. The certification in this clause is a material representation of fact upon which reliance was placed when this transaction was entered into. If it is later determined that the prospective lower tier participant knowingly rendered an erroneous certification, in addition to other remedies available to the Federal Government, the department, or agency with which this transaction originated may pursue available remedies, including suspension and/or debarment.

- c. The prospective lower tier participant shall provide immediate written notice to the person to which this proposal is submitted if at any time the prospective lower tier participant learns that its certification was erroneous by reason of changed circumstances.
- d. The terms "covered transaction," "debarred," "suspended," "ineligible," "participant," "person," "principal," and "voluntarily excluded," as used in this clause, are defined in 2 CFR Parts 180 and 1200. You may contact the person to which this proposal is submitted for assistance in obtaining a copy of those regulations. "First Tier Covered Transactions" refers to any covered transaction between a grantee or subgrantee of Federal funds and a participant (such as the prime or general contract). "Lower Tier Covered Transactions" refers to any covered transaction under a First Tier Covered Transaction (such as subcontracts). "First Tier Participant" refers to the participant who has entered into a covered transaction with a grantee or subgrantee of Federal funds (such as the prime or general contractor). "Lower Tier Participant" refers any participant who has entered into a covered transaction with a First Tier Participant or other Lower Tier Participants (such as subcontractors and suppliers).
- e. The prospective lower tier participant agrees by submitting this proposal that, should the proposed covered transaction be entered into, it shall not knowingly enter into any lower tier covered transaction with a person who is debarred, suspended, declared ineligible, or voluntarily excluded from participation in this covered transaction, unless authorized by the department or agency with which this transaction originated.
- f. The prospective lower tier participant further agrees by submitting this proposal that it will include this clause titled "Certification Regarding Debarment, Suspension, Ineligibility and Voluntary Exclusion--Lower Tier Covered Transaction," without modification, in all lower tier covered transactions and in all solicitations for lower tier covered transactions exceeding the \$25,000 threshold.
- g. A participant in a covered transaction may rely upon a certification of a prospective participant in a lower tier covered transaction that is not debarred, suspended, ineligible, or voluntarily excluded from the covered transaction, unless it knows that the certification is erroneous. A participant is responsible for ensuring that its principals are not suspended, debarred, or otherwise ineligible to participate in covered transactions. To verify the eligibility of its principals, as well as the eligibility of any lower tier prospective participants, each participant may, but is not required to, check the Excluded Parties List System website (<https://www.epls.gov/>), which is compiled by the General Services Administration.
- h. Nothing contained in the foregoing shall be construed to require establishment of a system of records in order to render in good faith the certification required by this clause. The knowledge and information of participant is not required to exceed that which is normally possessed by a prudent person in the ordinary course of business dealings.
- i. Except for transactions authorized under paragraph e of these instructions, if a participant in a covered transaction knowingly enters into a lower tier covered transaction with a person who is suspended, debarred, ineligible, or voluntarily excluded from participation in this transaction, in addition to other remedies available to the Federal Government, the department or agency with which this transaction originated may pursue available remedies, including suspension and/or debarment.

\* \* \* \* \*

**Certification Regarding Debarment, Suspension, Ineligibility and Voluntary Exclusion--Lower Tier Participants:**

1. The prospective lower tier participant certifies, by submission of this proposal, that neither it nor its principals is presently debarred, suspended, proposed for debarment, declared ineligible, or voluntarily excluded from participating in covered transactions by any Federal department or agency.
2. Where the prospective lower tier participant is unable to certify to any of the statements in this certification, such prospective participant shall attach an explanation to this proposal.

\* \* \* \* \*

**XI. CERTIFICATION REGARDING USE OF CONTRACT FUNDS FOR LOBBYING**

This provision is applicable to all Federal-aid construction contracts and to all related subcontracts which exceed \$100,000 (49 CFR 20).

1. The prospective participant certifies, by signing and submitting this bid or proposal, to the best of his or her knowledge and belief, that:
  - a. No Federal appropriated funds have been paid or will be paid, by or on behalf of the undersigned, to any person for influencing or attempting to influence an officer or employee of any Federal agency, a Member of Congress, an officer or employee of Congress, or an employee of a Member of Congress in connection with the awarding of any Federal contract, the making of any Federal grant, the making of any Federal loan, the entering into of any cooperative agreement, and the extension, continuation, renewal, amendment, or modification of any Federal contract, grant, loan, or cooperative agreement.
  - b. If any funds other than Federal appropriated funds have been paid or will be paid to any person for influencing or attempting to influence an officer or employee of any Federal agency, a Member of Congress, an officer or employee of Congress, or an employee of a Member of Congress in connection with this Federal contract, grant, loan, or cooperative agreement, the undersigned shall complete and submit Standard Form-LLL, "Disclosure Form to Report Lobbying," in accordance with its instructions.
2. This certification is a material representation of fact upon which reliance was placed when this transaction was made or entered into. Submission of this certification is a prerequisite for making or entering into this transaction imposed by 31 U.S.C. 1352. Any person who fails to file the required certification shall be subject to a civil penalty of not less than \$10,000 and not more than \$100,000 for each such failure.
3. The prospective participant also agrees by submitting its bid or proposal that the participant shall require that the language of this certification be included in all lower tier subcontracts, which exceed \$100,000 and that all such recipients shall certify and disclose accordingly.

**STANDARD SPECIAL PROVISION****ON-THE-JOB TRAINING**

(10-16-07) (Rev. 4-21-15)

Z-10

**Description**

The North Carolina Department of Transportation will administer a custom version of the Federal On-the-Job Training (OJT) Program, commonly referred to as the Alternate OJT Program. All contractors (existing and newcomers) will be automatically placed in the Alternate Program. Standard OJT requirements typically associated with individual projects will no longer be applied at the project level. Instead, these requirements will be applicable on an annual basis for each contractor administered by the OJT Program Manager.

On the Job Training shall meet the requirements of 23 CFR 230.107 (b), 23 USC – Section 140, this provision and the On-the-Job Training Program Manual.

The Alternate OJT Program will allow a contractor to train employees on Federal, State and privately funded projects located in North Carolina. However, priority shall be given to training employees on NCDOT Federal-Aid funded projects.

**Minorities and Women**

Developing, training and upgrading of minorities and women toward journeyman level status is a primary objective of this special training provision. Accordingly, the Contractor shall make every effort to enroll minority and women as trainees to the extent that such persons are available within a reasonable area of recruitment. This training commitment is not intended, and shall not be used, to discriminate against any applicant for training, whether a member of a minority group or not.

**Assigning Training Goals**

The Department, through the OJT Program Manager, will assign training goals for a calendar year based on the contractors' past three years' activity and the contractors' anticipated upcoming year's activity with the Department. At the beginning of each year, all contractors eligible will be contacted by the Department to determine the number of trainees that will be assigned for the upcoming calendar year. At that time the Contractor shall enter into an agreement with the Department to provide a self-imposed on-the-job training program for the calendar year. This agreement will include a specific number of annual training goals agreed to by both parties. The number of training assignments may range from 1 to 15 per contractor per calendar year. The Contractor shall sign an agreement to fulfill their annual goal for the year.\

**Training Classifications**

The Contractor shall provide on-the-job training aimed at developing full journeyman level workers in the construction craft/operator positions. Preference shall be given to providing training in the following skilled work classifications:

Equipment Operators	Office Engineers
Truck Drivers	Estimators
Carpenters	Iron / Reinforcing Steel Workers
Concrete Finishers	Mechanics
Pipe Layers	Welders

The Department has established common training classifications and their respective training requirements that may be used by the contractors. However, the classifications established are not all-inclusive. Where the training is oriented toward construction applications, training will be allowed in lower-level management positions such as office engineers and estimators. Contractors shall submit new classifications for specific job functions that their employees are performing. The Department will review and recommend for acceptance to FHWA the new classifications proposed by contractors, if applicable. New classifications shall meet the following requirements:

Proposed training classifications are reasonable and realistic based on the job skill classification needs, and

The number of training hours specified in the training classification is consistent with common practices and provides enough time for the trainee to obtain journeyman level status.

The Contractor may allow trainees to be trained by a subcontractor provided that the Contractor retains primary responsibility for meeting the training and this provision is made applicable to the subcontract. However, only the Contractor will receive credit towards the annual goal for the trainee.

Where feasible, 25 percent of apprentices or trainees in each occupation shall be in their first year of apprenticeship or training. The number of trainees shall be distributed among the work classifications on the basis of the contractor's needs and the availability of journeymen in the various classifications within a reasonable area of recruitment.

No employee shall be employed as a trainee in any classification in which they have successfully completed a training course leading to journeyman level status or in which they have been employed as a journeyman.

**Records and Reports**

The Contractor shall maintain enrollment, monthly and completion reports documenting company compliance under these contract documents. These documents and any other information as requested shall be submitted to the OJT Program Manager.

Upon completion and graduation of the program, the Contractor shall provide each trainee with a certification Certificate showing the type and length of training satisfactorily completed.

**Trainee Interviews**

All trainees enrolled in the program will receive an initial and Trainee/Post graduate interview conducted by the OJT program staff.

**Trainee Wages**

Contractors shall compensate trainees on a graduating pay scale based upon a percentage of the prevailing minimum journeyman wages (Davis-Bacon Act). Minimum pay shall be as follows:

60 percent	of the journeyman wage for the first half of the training period
75 percent	of the journeyman wage for the third quarter of the training period
90 percent	of the journeyman wage for the last quarter of the training period

In no instance shall a trainee be paid less than the local minimum wage. The Contractor shall adhere to the minimum hourly wage rate that will satisfy both the NC Department of Labor (NCDOL) and the Department.

**Achieving or Failing to Meet Training Goals**

The Contractor will be credited for each trainee employed by him on the contract work who is currently enrolled or becomes enrolled in an approved program and who receives training for at least 50 percent of the specific program requirement. Trainees will be allowed to be transferred between projects if required by the Contractor's scheduled workload to meet training goals.

If a contractor fails to attain their training assignments for the calendar year, they may be taken off the NCDOT's Bidders List.

**Measurement and Payment**

No compensation will be made for providing required training in accordance with these contract documents.

**STANDARD SPECIAL PROVISION**

**NAME CHANGE FOR NCDENR**

(1-19-16)

Z-11

**Description**

Wherever in the 2012 Standard Specifications, Project Special Provisions, Standard Special Provisions, Permits or Plans that reference is made to “NCDENR” or “North Carolina Department of Environment and Natural Resources”, replace with “NCDEQ” or “North Carolina Department of Environmental Quality” respectively, as the case may be.



**STANDARD SPECIAL PROVISION**  
**MINIMUM WAGES**  
**GENERAL DECISION NC150101 01/23/2015 NC101**

Z-101

Date: January 23, 2015

General Decision Number: NC150101 01/23/2015 NC101

Superseded General Decision Numbers: NC20140101

State: North Carolina

Construction Type: HIGHWAY

**COUNTIES:**

Alamance	Forsyth	Randolph
Anson	Gaston	Rockingham
Cabarrus	Guilford	Stokes
Chatham	Mecklenburg	Union
Davie	Orange	Yadkin
Durham	Person	

HIGHWAY CONSTRUCTION PROJECTS (excluding tunnels, building structures in rest area projects & railroad construction; bascule, suspension & spandrel arch bridges designed for commercial navigation, bridges involving marine construction; and other major bridges).

Note: Executive Order (EO) 13658 establishes an hourly minimum wage of \$10.10 for 2015 that applies to all contracts subject to the Davis-Bacon Act for which the solicitation is issued on or after January 1, 2015. If this contract is covered by the EO, the contractor must pay all workers in any classification listed on this wage determination at least \$10.10 (or the applicable wage rate listed on this wage determination, if it is higher) for all hours spent performing on the contract. The EO minimum wage rate will be adjusted annually. Additional information on contractor requirements and worker protections under the EO is available at [www.dol.gov/whd/govcontracts](http://www.dol.gov/whd/govcontracts).

Modification Number

0

1

Publication Date

01/02/2015

01/23/2015

SUNC2014-003 11/14/2014

	Rates	Fringes
BLASTER	18.64	
CARPENTER	13.68	.05
CEMENT MASON/CONCRETE FINISHER	13.93	
ELECTRICIAN		
Electrician	18.79	2.72
Telecommunications Technician	15.19	1.25
IRONWORKER	13.30	
LABORER		
Asphalt Raker and Spreader	12.78	

	Rates	Fringes
Asphalt Screed/Jackman	14.50	
Carpenter Tender	12.51	.27
Cement Mason/Concrete Finisher Tender	11.04	
Common or General	10.40	.01
Guardrail/Fence Installer	13.22	
Pipelayer	12.43	
Traffic Signal/Lighting Installer	15.65	.24
<b>PAINTER</b>		
Bridge	23.77	
<b>POWER EQUIPMENT OPERATORS</b>		
Asphalt Broom Tractor	10.00	
Bulldozer Fine	16.13	
Bulldozer Rough	14.36	
Concrete Grinder/Groover	17.92	
Crane Boom Trucks	18.19	
Crane Other	19.83	
Crane Rough/All-Terrain	19.10	
Drill Operator Rock	14.28	
Drill Operator Structure	20.89	
Excavator Fine	16.95	
Excavator Rough	13.63	
Grader/Blade Fine	19.84	
Grader/Blade Rough	15.47	
Loader 2 Cubic Yards or Less	13.31	
Loader Greater Than 2 Cubic Yards	16.19	
Material Transfer Vehicle (Shuttle Buggy)	15.44	
Mechanic	17.51	
Milling Machine	15.22	
Off-Road Hauler/Water Tanker	11.83	
Oiler/Greaser	14.16	
Pavement Marking Equipment	12.05	
Paver Asphalt	15.97	
Paver Concrete	18.20	
Roller Asphalt Breakdown	12.79	
Roller Asphalt Finish	13.76	
Roller Other	12.08	
Scraper Finish	12.65	
Scraper Rough	11.50	
Slip Form Machine	19.60	
Tack Truck/Distributor Operator	14.82	
<b>TRUCK DRIVER</b>		
GVWR of 26,000 Lbs or Less	11.45	
GVWR of 26,000 Lbs or Greater	13.57	.03

Welders – Receive rate prescribed for craft performing operation to which welding is incidental.

Unlisted classifications needed for work not included within the scope of the classifications listed may be added after award only as provided in the labor standards contract clauses (29 CFR 5.5(a)(1)(ii)).

The body of each wage determination lists the classification and wage rates that have been found to be prevailing for the cited type(s) of construction in the area covered by the wage determination. The classifications are listed in alphabetical order of "identifiers" that indicate whether the particular rate is a union rate (current union negotiated rate for local), a survey rate (weighted average rate) or a union average rate (weighted union average rate).

#### Union Rate Identifiers

A four letter classification abbreviation identifier enclosed in dotted lines beginning with characters other than "SU" or "UAVG" denotes that the union classification and rate were prevailing for that classification in the survey. Example: PLUM0198-005 07/01/2014. PLUM is an abbreviation identifier of the union which prevailed in the survey for this classification, which in this example would be Plumbers. 0198 indicates the local union number or district council number where applicable, i.e., Plumbers Local 0198. The next number, 005 in the example, is an internal number used in processing the wage determination. 07/01/2014 is the effective date of the most current negotiated rate, which in this example is July 1, 2014.

Union prevailing wage rates are updated to reflect all rate changes in the collective bargaining agreement (CBA) governing this classification and rate.

#### Survey Rate Identifiers

Classifications listed under the "SU" identifier indicate that no one rate prevailed for this classification in the survey and the published rate is derived by computing a weighted average rate based on all the rates reported in the survey for that classification. As this weighted average rate includes all rates reported in the survey, it may include both union and non-union rates. Example: SULA2012-007 5/13/2014. SU indicates the rates are survey rates based on a weighted average calculation of rates and are not majority rates. LA indicates the State of Louisiana. 2012 is the year of survey on which these classifications and rates are based. The next number, 007 in the example, is an internal number used in producing the wage determination. 5/13/2014 indicates the survey completion date for the classifications and rates under that identifier.

Survey wage rates are not updated and remain in effect until a new survey is conducted.

#### Union Average Rate Identifiers

Classification(s) listed under the UAVG identifier indicate that no single majority rate prevailed for those classifications; however, 100% of the data reported for the classifications was union data. EXAMPLE: UAVG-OH-0010 08/29/2014. UAVG indicates that the rate is a weighted union average rate. OH indicates the state. The next number, 0010 in the example, is an internal number used in producing the wage determination. 08/29/2014 indicates the survey completion date for the classifications and rates under that identifier.

A UAVG rate will be updated once a year, usually in January of each year, to reflect a weighted average of the current negotiated/CBA rate of the union locals from which the rate is based.

## WAGE DETERMINATION APPEALS PROCESS

1.) Has there been an initial decision in the matter? This can be:

- \* an existing published wage determination
- \* a survey underlying a wage determination
- \* a Wage and Hour Division letter setting forth a position on a wage determination matter
- \* a conformance (additional classification and rate) ruling

On survey related matters, initial contact, including requests for summaries of surveys, should be with the Wage and Hour Regional Office for the area in which the survey was conducted because those Regional Offices have responsibility for the Davis-Bacon survey program. If the response from this initial contact is not satisfactory, then the process described in 2.) and 3.) should be followed.

With regard to any other matter not yet ripe for the formal process described here, initial contact should be with the Branch of Construction Wage Determinations. Write to:

Branch of Construction Wage Determinations  
Wage and Hour Division  
U. S. Department of Labor  
200 Constitution Avenue, N.W.  
Washington, D.C. 20210

2.) If the answer to the question in 1.) is yes, then an interested party (those affected by the action) can request review and reconsideration from the Wage and Hour Administrator (See 29 CFR Part 1.8 and 29 CFR Part 7). Write to:

Wage and Hour Administrator  
U.S. Department of Labor  
200 Constitution Avenue, N.W.  
Washington, D.C. 20210

The request should be accompanied by a full statement of the interested party's position and by any information (wage payment data, project description, area practice material, etc.) that the requestor considers relevant to the issue.

3.) If the decision of the Administrator is not favorable, an interested party may appeal directly to the Administrative Review Board (formerly the Wage Appeals Board). Write to:

Administrative Review Board  
U.S. Department of Labor  
200 Constitution Avenue, N.W.  
Washington, D.C. 20210

4.) All decisions by the Administrative Review Board are final.

END OF GENERAL DECISION

Project: B-5243

UC-1

County: Union

PROJECT SPECIAL PROVISIONS  
Utility Construction

**B. Chad Houser, PE, PLS** | Project Manager  
**TGS Engineers**  
 804-C N. Lafayette St. | Shelby, NC 28150 | 704-476-0003 ex 311  
[chouser@tgsengineers.com](mailto:chouser@tgsengineers.com)

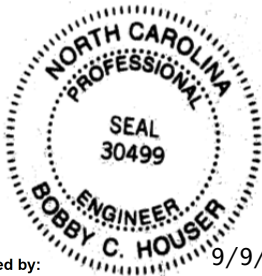

DocuSigned by:  
*Bobby Chad Houser* (Seal)  
 9/9/2015  
 0BFA26F63564434...

**Revise the 2012 Standard Specifications as follows:**

**Page 10-58, Sub-article 1036-1 General**

add the following sentence:

All materials in contact with potable water shall be in conformance with Section 1417 of the Safe Drinking Water Act.

**Page 15-1, Sub-article 1500-2 Cooperation with the Utility Owner, paragraph 2:**

add the following sentences:

Utility owner is Union County. The contact person is Mr. Michael Caldwell, Project Manager and he can be reached by phone at (704)296-4293.

**Page 15-2, Sub-article 1500-9 Placing Pipelines into Service**

add the following sentence:

Obtain approval from the NCDENR-Public Water Supply Section prior to placing a new water line into service. Use backflow prevention assemblies for temporary connections to isolate new water lines from existing water line.

**Page 15-6, Sub-article 1510-3 (B), Testing and Sterilization**

change the allowable leakage formula to:

$$W = LD\sqrt{P} \div 148,000$$

**Page 15-6, Sub-article 1510-3 (B), Testing and Sterilization, sixth paragraph:**

Replace the paragraph with the following:

Sterilize water lines in accordance with Section 1003 of The Rules Governing Public Water supply and AWWA C651 Section 4.4.3, the Continuous Feed Method. Provide a chlorine solution with between 50 parts per million and 100 parts per million in the initial feed. If the chlorine level drops below 10 parts per million during a 24 hour period, then

Project: B-5243

**UC-2**

County: Union

**PROJECT SPECIAL PROVISIONS****Utility Construction**

flush, refill with fresh chlorine solution, and repeat for 24 hours. Provide certified bacteriological and contaminant test results from a state-approved or state-certified laboratory. Operate all valves and controls to assure thorough sterilization.

**Page 15-6, Sub-article 1510-3 (B), Testing and Sterilization, seventh paragraph:** delete the words “may be performed concurrently or consecutively.” and replace with “shall be performed consecutively.”

**Page 15-7, sub-article 1515-2 Materials,**

replace paragraph beginning “Double check valves...” with the following:

Double Check valves (DCV) and Reduced Pressure Zone principal (RPZ) backflow prevention assemblies shall be listed on the University of Southern California Foundation for Cross-Connection Control and Hydraulic Research list of approved backflow devices.

**Page 15-11, Sub-article 1520-3(A)(2) Testing, line 5,**

replace the second paragraph with the following:

Test all 24" and smaller gravity sewer lines for leakage using infiltration, exfiltration, or air test. Perform visual inspection on gravity sewer lines larger than 24". Perform line and grade testing and deflection testing on all gravity sewer lines.

**Project Information:**

All proposed utility construction shall meet the applicable requirements of the NC Department of Transportation's "Standard Specifications for Roads and Structures" dated January 2012.

Provide access for Department personnel and the owner's representatives to all phases of construction. Notify Department personnel and the utility owner two weeks prior to commencement of any work and one week prior to service interruption. Keep utility owner's representatives informed of work progress and provide opportunity for inspection of construction and testing. Any work on these lines must be coordinated through the Engineer and the utility owner before beginning.

Project: B-5243

**UC-3**

County: Union

**PROJECT SPECIAL PROVISIONS**

**Utility Construction**

**Rigid Restrained Joint Ductile Iron Pipe**

Ductile Iron Restrained Joint Pipe installed under this Contract shall be installed at locations shown on the utility plans and/or directed by the Engineer.

This item includes furnishing all materials, equipment, and labor required to install rigid joint ductile iron pipe (including fittings), as specified and as shown on the Plans. The Contractor shall be responsible for installing the restrained joints in accordance with manufacturer's recommendations regarding assembly, deflection, and installation. Ductile iron pipe installation shall meet the requirements of AWWA Specification C 151 and ANSI Standard #A21-51. Ductile iron pipe shall be mechanical joint or push-on joint type. All joints for ductile iron pipe shall conform to the applicable dimensions and weights shown in the tables in AWWA C151 and to ANSI A 21.11 (AWWA C111) or latest revision.

**Payment**

No direct payment will be made for utility construction work required by the preceding provision, which are general requirements applying to utility construction, and all of the requirements stated will be considered incidental work, paid at the contract unit prices of the various utility items include in this contract.



**General:**

The following utility companies have facilities that will be in conflict with the construction of this project:

- A. Duke Energy – Power (Distribution)
- B. Time Warner - Communications
- C. MCNC - Communications
- D. Broadplex - Communications
- E. Piedmont Natural Gas
- F. Windstream - Communications

The conflicting facilities of these concerns will be adjusted prior to the date of availability, unless otherwise noted and are therefore listed in these special provisions for the benefit of the Contractor. All utility work listed herein will be done by the utility owners. All utilities are shown on the plans from the best available information.

The Contractor’s attention is directed to Article 105.8 of the Standard Specifications.

**Utilities Requiring Adjustment:**

Utility relocations are shown on the Utility by Others Plans.

A) Duke Energy – Power (Distribution)

Contact Information: Don Lefler  
2818 South Main Street  
Concord, NC 28027  
704-788-4949  
Don.lefler@duke-energy.com

- 1) See Utilities by Others Plans.
- 2) Duke Energy will complete all relocation work including temporary line and new locations by February 01, 2016. This is all relocation work including the temporary lines at the new bridge locations.
- 3) Duke has accepted being located within a DUE area with new running lines.

B) Time Warner Cable

Contact Information: Craig Morgan  
813 N. Charlotte Hwy



Monroe, NC 28110  
704-378-3020  
Craig.morgan@twcable.com

1. See Utilities by Others Plans.
2. Time Warner will relocate aerially to new proposed Duke Distribution poles.
3. Time Warner is proposing 1 bore under Indian Trail Road South @ station 19+00.
4. Time Warner will need 2 weeks to complete work once Duke Distribution is complete.
5. Time Warner will be completed prior to February 19, 2016.

**C) MCNC - Communications**

Contact Information: Paul Shaw  
3021 East Cornwallis Road  
Research Triangle Park, NC 27709  
919-248-1467  
pshaw@mailbox.mcnc.org

1. See Utilities by Others Plans.
2. All MCNC relocations will be joint with Broadplex.
3. Joint bore with Broadplex from station 10+80L to station 19+22 Left.
4. MCNC and Broadplex will be completed with all relocation work prior to February 19, 2016

**D) Broadplex - Communications**

Contact Information: Jeff Mathews  
100 East Meeting Street  
Morganton, NC 28655  
828-228-2034  
Jeff.mathews@broadplex.net

1. See Utilities by Others Plans.
2. Broadplex will complete all relocation work for MCNC also.
3. Broadplex will complete a bore on the Left side of SR 1008 from station 10+80 to station 19+22.
4. Broadplex and MCNC will be completed by February 19, 2016.

**E) Piedmont Natural Gas - Gas**

Contact Information: Kathy Faircloth  
5601 Cannon Drive  
Monroe, NC 28110

704-282-8468  
Kathy.faircloth@piedmontng.com

1. See Utilities by Others Plans.
2. Piedmont will be completing a bore from station 19+00 Left to station 24+50 Left to avoid drainage and bridge replacement.
3. Piedmont will need 6 weeks to schedule work and 2 weeks to complete new bore.
4. Work will begin October 2015 and will be completed by February 2016
5. All work will be completed by February 19, 2016.

F) Windstream – Communications

Contact Information: Mike Foster  
131 West Matthews Street  
Matthews, NC 28106-0426  
704-575-3770  
[Mike.foster@windstream.com](mailto:Mike.foster@windstream.com)

1. See Utilities by Others Plans.
2. Windstream will be relocating to new Duke Distribution pole line.
3. Windstream has transferred ownership of pole on Old Monroe Road to Duke.
4. Windstream will need 2 weeks to complete work once Duke has completed work.
5. Windstream will be completed by February 19, 2016.

**Project Special Provisions  
Erosion Control**

**STABILIZATION REQUIREMENTS:**

Stabilization for this project shall comply with the time frame guidelines as specified by the NCG-010000 general construction permit effective August 3, 2011 issued by the North Carolina Department of Environment and Natural Resources Division of Water Quality. Temporary or permanent ground cover stabilization shall occur within 7 calendar days from the last land-disturbing activity, with the following exceptions in which temporary or permanent ground cover shall be provided in 14 calendar days from the last land-disturbing activity:

- Slopes between 2:1 and 3:1, with a slope length of 10 ft. or less
- Slopes 3:1 or flatter, with a slope of length of 50 ft. or less
- Slopes 4:1 or flatter

The stabilization timeframe for High Quality Water (HQW) Zones shall be 7 calendar days with no exceptions for slope grades or lengths. High Quality Water Zones (HQW) Zones are defined by North Carolina Administrative Code 15A NCAC 04A.0105 (25). Temporary and permanent ground cover stabilization shall be achieved in accordance with the provisions in this contract and as directed.

**SEEDING AND MULCHING:**

**(West)**

The kinds of seed and fertilizer, and the rates of application of seed, fertilizer, and limestone, shall be as stated below. During periods of overlapping dates, the kind of seed to be used shall be determined. All rates are in pounds per acre.

**Shoulder and Median Areas**

**August 1 - June 1**

20#	Kentucky Bluegrass
75#	Hard Fescue
25#	Rye Grain
500#	Fertilizer
4000#	Limestone

**May 1 - September 1**

20#	Kentucky Bluegrass
75#	Hard Fescue
10#	German or Browntop Millet
500#	Fertilizer
4000#	Limestone

**Areas Beyond the Mowing Pattern, Waste and Borrow Areas:**

**August 1 - June 1**

100#	Tall Fescue
15#	Kentucky Bluegrass
30#	Hard Fescue
25#	Rye Grain
500#	Fertilizer
4000#	Limestone

**May 1 - September 1**

100#	Tall Fescue
15#	Kentucky Bluegrass
30#	Hard Fescue
10#	German or Browntop Millet
500#	Fertilizer
4000#	Limestone

## Approved Tall Fescue Cultivars

06 Dust	Escalade	Justice	Scorpion
2 <sup>nd</sup> Millennium	Essential	Kalahari	Serengeti
3 <sup>rd</sup> Millennium	Evergreen 2	Kentucky 31*	Shelby
Apache III	Falcon IV	Kitty Hawk 2000	Sheridan
Avenger	Falcon NG	Legitimate	Signia
Barlexas	Falcon V	Lexington	Silver Hawk
Barlexas II	Faith	LSD	Sliverstar
Bar Fa	Fat Cat	Magellan	Shenandoah Elite
Barrera	Festnova	Matador	Sidewinder
Barrington	Fidelity	Millennium SRP	Skyline
Barrobusto	Finelawn Elite	Monet	Solara
Barvado	Finelawn Xpress	Mustang 4	Southern Choice II
Biltmore	Finesse II	Ninja 2	Speedway
Bingo	Firebird	Ol' Glory	Spyder LS
Bizem	Firecracker LS	Olympic Gold	Sunset Gold
Blackwatch	Firenza	Padre	Taccoa
Blade Runner II	Five Point	Patagonia	Tanzania
Bonsai	Focus	Pedigree	Trio
Braveheart	Forte	Picasso	Tahoe II
Bravo	Garrison	Piedmont	Talladega
Bullseye	Gazelle II	Plantation	Tarheel
Cannavaro	Gold Medallion	Proseeds 5301	Terrano
Catalyst	Grande 3	Prospect	Titan ltd
Cayenne	Greenbrooks	Pure Gold	Titanium LS
Cessane Rz	Greenkeeper	Quest	Tracer
Chipper	Gremlin	Raptor II	Traverse SRP
Cochise IV	Greystone	Rebel Exeda	Tulsa Time
Constitution	Guardian 21	Rebel Sentry	Turbo
Corgi	Guardian 41	Rebel IV	Turbo RZ
Corona	Hemi	Regiment II	Tuxedo RZ
Coyote	Honky Tonk	Regenerate	Ultimate
Darlington	Hot Rod	Rendition	Venture
Davinci	Hunter	Rhambler 2 SRP	Umbrella
Desire	Inferno	Rembrandt	Van Gogh
Dominion	Innovator	Reunion	Watchdog
Dynamic	Integrity	Riverside	Wolfpack II
Dynasty	Jaguar 3	RNP	Xtremegreen
Endeavor	Jamboree	Rocket	

**\*Note: Kentucky 31 will no longer be an approved NCDOT Tall Fescue Cultivar after December 31, 2015.**

## Approved Kentucky Bluegrass Cultivars:

4-Season	Blue Velvet	Gladstone	Quantum Leap
Alexa II	Blueberry	Granite	Rambo
America	Boomerang	Hampton	Rhapsody
Apollo	Brilliant	Harmonie	Rhythm
Arcadia	Cabernet	Impact	Rita
Aries	Champagne	Jefferson	Royce
Armada	Champlain	Juliet	Rubicon
Arrow	Chicago II	Jump Start	Rugby II
Arrowhead	Corsair	Keeneland	Shiraz
Aura	Courtyard	Langara	Showcase
Avid	Delight	Liberator	Skye
Award	Diva	Madison	Solar Eclipse
Awesome	Dynamo	Mercury	Sonoma
Bandera	Eagleton	Midnight	Sorbonne
Barduke	Emblem	Midnight II	Starburst
Barnique	Empire	Moon Shadow	Sudden Impact
Baroness	Envicta	Moonlight SLT	Total Eclipse
Barrister	Everest	Mystere	Touche
Barvette HGT	Everglade	Nu Destiny	Tsunami
Bedazzled	Excursion	NuChicago	Unique
Belissimo	Freedom II	NuGlade	Valor
Bewitched	Freedom III	Odyssey	Voyager II
Beyond	Front Page	Perfection	Washington
Blacksburg II	Futurity	Pinot	Zinfandel
Blackstone	Gaelic	Princeton 105	
Blue Note	Ginney II	Prosperity	

## Approved Hard Fescue Cultivars:

Aurora II	Eureka II	Oxford	Scaldis II
Aurora Gold	Firefly	Reliant II	Spartan II
Berkshire	Granite	Reliant IV	Stonehenge
Bighorn GT	Heron	Rescue 911	
Chariot	Nordic	Rhino	

On cut and fill slopes 2:1 or steeper add 20# Sericea Lespedeza January 1 - December 31.

Fertilizer shall be 10-20-20 analysis. A different analysis of fertilizer may be used provided the 1-2-2 ratio is maintained and the rate of application adjusted to provide the same amount of plant food as a 10-20-20 analysis and as directed.

**Native Grass Seeding And Mulching**

**(West)**

Native Grass Seeding and Mulching shall be performed on the disturbed areas of wetlands and riparian areas, and adjacent to Stream Relocation and/or trout stream construction within a 50 foot zone on both sides of the stream or depression, measured from top of stream bank or center of depression. The stream bank of the stream relocation shall be seeded by a method that does not alter the typical cross section of the stream bank. Native Grass Seeding and Mulching shall also be performed in the permanent soil reinforcement mat section of preformed scour holes, and in other areas as directed.

The kinds of seed and fertilizer, and the rates of application of seed, fertilizer, and limestone, shall be as stated below. During periods of overlapping dates, the kind of seed to be used shall be determined. All rates are in pounds per acre.

**August 1 - June 1**

- 18# Creeping Red Fescue
- 8# Big Bluestem
- 6# Indiangrass
- 4# Switchgrass
- 35# Rye Grain
- 500# Fertilizer
- 4000# Limestone

**May 1 – September 1**

- 18# Creeping Red Fescue
- 8# Big Bluestem
- 6# Indiangrass
- 4# Switchgrass
- 25# German or Browntop Millet
- 500# Fertilizer
- 4000# Limestone

Approved Creeping Red Fescue Cultivars:

- Aberdeen
- Boreal
- Epic
- Cindy Lou

Fertilizer shall be 10-20-20 analysis. A different analysis of fertilizer may be used provided the 1-2-2 ratio is maintained and the rate of application adjusted to provide the same amount of plant food as a 10-20-20 analysis and as directed.

Native Grass Seeding and Mulching shall be performed in accordance with Section 1660 of the *Standard Specifications* and vegetative cover sufficient to restrain erosion shall be installed immediately following grade establishment.

**Measurement and Payment**

Native Grass *Seeding and Mulching* will be measured and paid for in accordance with Article 1660-8 of the *Standard Specifications*.

**TEMPORARY SEEDING:**

Fertilizer shall be the same analysis as specified for *Seeding and Mulching* and applied at the rate of 400 pounds and seeded at the rate of 50 pounds per acre. German Millet, or Browntop Millet shall be used in summer months and rye grain during the remainder of the year. The Engineer will determine the exact dates for using each kind of seed.

**FERTILIZER TOPDRESSING:**

Fertilizer used for topdressing shall be 16-8-8 grade and shall be applied at the rate of 500 pounds per acre. A different analysis of fertilizer may be used provided the 2-1-1 ratio is maintained and the rate of application adjusted to provide the same amount of plant food as 16-8-8 analysis and as directed.

**SUPPLEMENTAL SEEDING:**

The kinds of seed and proportions shall be the same as specified for *Seeding and Mulching*, and the rate of application may vary from 25# to 75# per acre. The actual rate per acre will be determined prior to the time of topdressing and the Contractor will be notified in writing of the rate per acre, total quantity needed, and areas on which to apply the supplemental seed. Minimum tillage equipment, consisting of a sod seeder shall be used for incorporating seed into the soil as to prevent disturbance of existing vegetation. A clodbuster (ball and chain) may be used where degree of slope prevents the use of a sod seeder.

**MOWING:**

The minimum mowing height on this project shall be six inches.

**LAWN TYPE APPEARANCE:**

All areas adjacent to lawns must be hand finished as directed to give a lawn type appearance. Remove all trash, debris, and stones  $\frac{3}{4}$ " and larger in diameter or other obstructions that could interfere with providing a smooth lawn type appearance. These areas shall be reseeded to match their original vegetative conditions, unless directed otherwise by the Field Operations Engineer.

**RESPONSE FOR EROSION CONTROL:****Description**

Furnish the labor, materials, tools and equipment necessary to move personnel, equipment, and supplies to the project necessary for the pursuit of any or all of the following work as shown herein, by an approved subcontractor.

<b>Section</b>	<b>Erosion Control Item</b>	<b>Unit</b>
1605	Temporary Silt Fence	LF
1606	Special Sediment Control Fence	LF/TON
1615	Temporary Mulching	ACR
1620	Seed - Temporary Seeding	LB
1620	Fertilizer - Temporary Seeding	TN
1631	Matting for Erosion Control	SY

SP	Coir Fiber Mat	SY
1640	Coir Fiber Baffles	LF
SP	Permanent Soil Reinforcement Mat	SY
1660	Seeding and Mulching	ACR
1661	Seed - Repair Seeding	LB
1661	Fertilizer - Repair Seeding	TON
1662	Seed - Supplemental Seeding	LB
1665	Fertilizer Topdressing	TON
SP	Safety/Highly Visible Fencing	LF
SP	Response for Erosion Control	EA

### Construction Methods

Provide an approved subcontractor who performs an erosion control action as described in the NPDES Inspection Form SPPP30. Each erosion control action may include one or more of the above work items.

### Measurement and Payment

*Response for Erosion Control* will be measured and paid for by counting the actual number of times the subcontractor moves onto the project, including borrow and waste sites, and satisfactorily completes an erosion control action described in Form 1675. The provisions of Article 104-5 of the *Standard Specifications* will not apply to this item of work.

Payment will be made under:

#### Pay Item

Response for Erosion Control

#### Pay Unit

Each

### **MINIMIZE REMOVAL OF VEGETATION:**

The Contractor shall minimize removal of vegetation within project limits to the maximum extent practicable. Vegetation along stream banks and adjacent to other jurisdictional resources outside the construction limits shall only be removed upon approval of Engineer. No additional payment will be made for this minimization work.

### **STOCKPILE AREAS:**

The Contractor shall install and maintain erosion control devices sufficient to contain sediment around any erodible material stockpile areas as directed.



**ACCESS AND HAUL ROADS:**

At the end of each working day, the Contractor shall install or re-establish temporary diversions or earth berms across access/haul roads to direct runoff into sediment devices. Silt fence sections that are temporarily removed shall be reinstalled across access/haul roads at the end of each working day.

**WASTE AND BORROW SOURCES:**

Payment for temporary erosion control measures, except those made necessary by the Contractor's own negligence or for his own convenience, will be paid for at the appropriate contract unit price for the devices or measures utilized in borrow sources and waste areas.

No additional payment will be made for erosion control devices or permanent seeding and mulching in any commercial borrow or waste pit. All erosion and sediment control practices that may be required on a commercial borrow or waste site will be done at the Contractor's expense.

All offsite Staging Areas, Borrow and Waste sites shall be in accordance with "Borrow and Waste Site Reclamation Procedures for Contracted Projects" located at:

[http://www.ncdot.gov/doh/operations/dp\\_chief\\_eng/roadside/fieldops/downloads/Files/ContractedReclamationProcedures.pdf](http://www.ncdot.gov/doh/operations/dp_chief_eng/roadside/fieldops/downloads/Files/ContractedReclamationProcedures.pdf)

All forms and documents referenced in the "Borrow and Waste Site Reclamation Procedures for Contracted Projects" shall be included with the reclamation plans for offsite staging areas, and borrow and waste sites.

**TEMPORARY DIVERSION:**

This work consists of installation, maintenance, and cleanout of *Temporary Diversions* in accordance with Section 1630 of the *Standard Specifications*. The quantity of excavation for installation and cleanout will be measured and paid for as *Silt Excavation* in accordance with Article 1630-3 of the *Standard Specifications*.

**SAFETY FENCE AND JURISDICTIONAL FLAGGING:****Description**

*Safety Fence* shall consist of furnishing materials, installing and maintaining polyethylene or polypropylene fence along the outside riparian buffer, wetland, or water boundary, or other boundaries located within the construction corridor to mark the areas that have been approved to infringe within the buffer, wetland, endangered vegetation, culturally sensitive areas or water. The fence shall be installed prior to any land disturbing activities.

Interior boundaries for jurisdictional areas noted above shall be delineated by stakes and highly visible flagging.

Jurisdictional boundaries at staging areas, waste sites, or borrow pits, whether considered outside or interior boundaries shall be delineated by stakes and highly visible flagging.

### **Materials**

#### (A) Safety Fencing

Polyethylene or polypropylene fence shall be a highly visible preconstructed safety fence approved by the Engineer. The fence material shall have an ultraviolet coating.

Either wood posts or steel posts may be used. Wood posts shall be hardwood with a wedge or pencil tip at one end, and shall be at least 5 ft. in length with a minimum nominal 2" x 2" cross section. Steel posts shall be at least 5 ft. in length, and have a minimum weight of 0.85 lb/ft of length.

#### (B) Boundary Flagging

Wooden stakes shall be 4 feet in length with a minimum nominal 3/4" x 1-3/4" cross section. The flagging shall be at least 1" in width. The flagging material shall be vinyl and shall be orange in color and highly visible.

### **Construction Methods**

No additional clearing and grubbing is anticipated for the installation of this fence. The fence shall be erected to conform to the general contour of the ground.

#### (A) Safety Fencing

Posts shall be set at a maximum spacing of 10 ft., maintained in a vertical position and hand set or set with a post driver. Posts shall be installed a minimum of 2 ft. into the ground. If hand set, all backfill material shall be thoroughly tamped. Wood posts may be sharpened to a dull point if power driven. Posts damaged by power driving shall be removed and replaced prior to final acceptance. The tops of all wood posts shall be cut at a 30-degree angle. The wood posts may, at the option of the Contractor, be cut at this angle either before or after the posts are erected.

The fence geotextile shall be attached to the wood posts with one 2" galvanized wire staple across each cable or to the steel posts with wire or other acceptable means.

Place construction stakes to establish the location of the safety fence in accordance with Article 105-9 or Article 801-1 of the *Standard Specifications*. No direct pay will be made for the staking of the safety fence. All stakeouts for safety fence shall be considered incidental to the work being paid for as "Construction Surveying", except that where there is no pay item for construction surveying, all safety fence stakeout will be performed by state forces.

The Contractor shall be required to maintain the safety fence in a satisfactory condition for the duration of the project as determined by the Engineer.

## (B) Boundary Flagging

Boundary flagging delineation of interior boundaries shall consist of wooden stakes on 25 feet maximum intervals with highly visible orange flagging attached. Stakes shall be installed a minimum of 6" into the ground. Interior boundaries may be staked on a tangent that runs parallel to buffer but must not encroach on the buffer at any location. Interior boundaries of hand clearing shall be identified with a different colored flagging to distinguish it from mechanized clearing.

Boundary flagging delineation of interior boundaries will be placed in accordance with Article 105-9 or Article 801-1 of the *Standard Specifications*. No direct pay will be made for delineation of the interior boundaries. This delineation will be considered incidental to the work being paid for as *Construction Surveying*, except that where there is no pay item or construction surveying the cost of boundary flagging delineation shall be included in the unit prices bid for the various items in the contract. Installation for delineation of all jurisdictional boundaries at staging areas, waste sites, or borrow pits shall consist of wooden stakes on 25 feet maximum intervals with highly visible orange flagging attached. Stakes shall be installed a minimum of 6" into the ground. Additional flagging may be placed on overhanging vegetation to enhance visibility but does not substitute for installation of stakes.

Installation of boundary flagging for delineation of all jurisdictional boundaries at staging areas, waste sites, or borrow pits shall be performed in accordance with Subarticle 230-4(B)(5) or Subarticle 802-2(F) of the *Standard Specifications*. No direct pay will be made for this delineation, as the cost of same shall be included in the unit prices bid for the various items in the contract.

The Contractor shall be required to maintain alternative stakes and highly visible flagging in a satisfactory condition for the duration of the project as determined by the Engineer.

**Measurement and Payment**

*Safety Fence* will be measured and paid as the actual number of linear feet of polyethylene or polypropylene fence installed in place and accepted. Such payment will be full compensation including but not limited to furnishing and installing fence geotextile with necessary posts and post bracing, staples, tie wires, tools, equipment and incidentals necessary to complete this work.

Payment will be made under:

<b>Pay Item</b>	<b>Pay Unit</b>
Safety Fence	Linear Foot

**PERMANENT SOIL REINFORCEMENT MAT:****Description**

This work consists of furnishing and placing *Permanent Soil Reinforcement Mat*, of the type specified, over previously prepared areas as directed.

**Materials**

The product shall be a permanent erosion control reinforcement mat and shall be constructed of synthetic or a combination of coconut and synthetic fibers evenly distributed throughout the mat between a bottom UV stabilized netting and a heavy duty UV stabilized top net. The matting shall be stitched together with UV stabilized polypropylene thread to form a permanent three-dimensional structure. The mat shall have the following minimum physical properties:

<b>Property</b>	<b>Test Method</b>	<b>Value</b>	<b>Unit</b>
Light Penetration	ASTM D6567	9	%
Thickness	ASTM D6525	0.40	in
Mass Per Unit Area	ASTM D6566	0.55	lb/sy
Tensile Strength	ASTM D6818	385	lb/ft
Elongation (Maximum)	ASTM D6818	49	%
Resiliency	ASTM D1777	>70	%
UV Stability *	ASTM D4355	≥80	%
Porosity (Permanent Net)	ECTC Guidelines	≥85	%
Maximum Permissible Shear Stress (Vegetated)	Performance Bench Test	≥8.0	lb/ft <sup>2</sup>
Maximum Allowable Velocity (Vegetated)	Performance Bench Test	≥16.0	ft/s

\*ASTM D1682 Tensile Strength and % strength retention of material after 1000 hours of exposure.

Submit a certification (Type 1, 2, or 3) from the manufacturer showing:

- (A) the chemical and physical properties of the mat used, and
- (B) conformance of the mat with this specification.

**Construction Methods**

Matting shall be installed in accordance with Subarticle 1631-3(B) of the *Standard Specifications*.

All areas to be protected with the mat shall be brought to final grade and seeded in accordance with Section 1660 of the *Standard Specifications*. The surface of the soil shall be smooth, firm, stable and free of rocks, clods, roots or other obstructions that would prevent the mat from lying

in direct contact with the soil surface. Areas where the mat is to be placed will not need to be mulched.

### Measurement and Payment

*Permanent Soil Reinforcement Mat* will be measured and paid for as the actual number of square yards measured along the surface of the ground over which Permanent Soil Reinforcement Mat is installed and accepted. Overlaps will not be included in the measurement, and will be considered as incidental to the work. Such payment shall be full compensation for furnishing and installing the mat, including overlaps, and for all required maintenance.

Payment will be made under:

<b>Pay Item</b>	<b>Pay Unit</b>
Permanent Soil Reinforcement Mat	Square Yard

### **SKIMMER BASIN WITH BAFFLES:**

#### **Description**

Provide a skimmer basin to remove sediment from construction site runoff at locations shown in the erosion control plans. See the Skimmer Basin with Baffles Detail sheet provided in the erosion control plans. Work includes constructing sediment basin, installation of temporary slope drain pipe and coir fiber baffles, furnishing, installation and cleanout of skimmer, providing and placing stone pad on bottom of basin underneath skimmer device, providing and placing a geotextile spillway liner, providing coir fiber mat stabilization for the skimmer outlet, disposing of excess materials, removing temporary slope drain, coir fiber baffles, geotextile liner and skimmer device, backfilling basin area with suitable material and providing proper drainage when basin area is abandoned.

#### **Materials**

<b>Item</b>	<b>Section</b>
Stone for Erosion Control, Class B	1042
Geotextile for Soil Stabilization, Type 4	1056
Fertilizer for Temporary Seeding	1060-2
Seed for Temporary Seeding	1060-4
Seeding and Mulching	1060-4
Matting for Erosion Control	1060-8
Staples	1060-8
Coir Fiber Mat	1060-14
Temporary Slope Drain	1622-2
Coir Fiber Baffle	1640

Provide appropriately sized and approved skimmer device.

Provide Schedule 40 PVC pipe with a length of 6 ft. to attach to the skimmer and the coupling connection to serve as the arm pipe. For skimmer sizes of 2.5 in. and smaller, the arm pipe diameter shall be 1.5 inches. For skimmer sizes of 3 in. and larger, refer to manufacturer recommendation.

Provide 4" diameter Schedule 40 PVC pipe to attach to coupling connection of skimmer to serve as the barrel pipe through the earthen dam.

Anchors: Staples, stakes, or reinforcement bars shall be used as anchors.

#### Wooden Stakes:

Provide hardwood stakes 12"- 24" long with a 2" x 2" nominal square cross section. One end of the stake must be sharpened or beveled to facilitate driving through the coir fiber mat and down into the underlying soil. The other end of the stake needs to have a 1"- 2" long head at the top with a 1"- 2" notch following to catch and secure the coir fiber mat.

#### Steel Reinforcement Bars:

Provide uncoated #10 steel reinforcement bars 24" nominal length. The bars shall have a 4" diameter bend at one end with a 4" straight section at the tip to catch and secure the coir fiber mat.

#### Staples:

Provide staples made of 0.125" diameter new steel wire formed into a *u* shape not less than 12" in length with a throat of 1" in width.

### Construction Methods

Excavate basin according to the erosion control plans with basin surface free of obstructions, debris, and pockets of low-density material. Install temporary slope drain pipe and construct the primary spillway according to the Skimmer Basin with Baffles Detail sheet in the erosion control plans. Temporary slope drain pipe at inlet of basin may be replaced by geotextile as directed. Construct the coir fiber baffles according to *Roadway Standard Drawings* No. 1640.01 and Section 1640 of the *Standard Specifications*.

Install skimmer device according to manufacturer recommendations. Install 4" Schedule 40 PVC pipe into dam on the lower side of basin 1 ft. from the bottom of the basin and according to the detail, and extend the pipe so the basin will drain. Attach a 6 ft. arm pipe to the coupling connection and skimmer according to manufacturer recommendations. The coupling shall be rigid and non-buoyant and not exceed a diameter of 4" and 12" in length. Attach the rope included with the skimmer to the tee between the vent socket and the tube inlet, and the other end to a wooden stake or metal post. Clean out skimmer device when it becomes clogged with sediment and/or debris and is unable to float at the top of water in skimmer basin. Take appropriate measures to avoid ice accumulation in the skimmer device. Construct a stone pad of

Class B stone directly underneath the skimmer device at bottom of basin. The pad shall be a minimum of 12" in height, and shall have a minimum cross sectional area of 4 ft. by 4 ft.

Line primary spillway with geotextile unrolled in the direction of flow and lay smoothly but loosely on soil surface without creases. Bury edges of geotextile in a trench at least 5" deep and tamp firmly. If geotextile for the primary spillway is not one continuous piece of material, make horizontal overlaps a minimum of 18" with upstream geotextile overlapping the downstream geotextile. Secure geotextile with eleven gauge wire staples shaped into a *u* shape with a length of not less than 12" and a throat not less than 1" in width. Place staples along outer edges and throughout the geotextile a maximum of 3 ft. horizontally and vertically. Geotextile shall be placed to the bottom and across the entire width of the basin according to the Skimmer Basin with Baffles detail. Place sealant inside basin around barrel pipe on top of geotextile with a minimum width of 6 in.

At the skimmer outlet, provide a smooth soil surface free from stones, clods, or debris that will prevent contact of the coir fiber matting with the soil. Unroll the matting and apply without stretching such that it will lie smoothly but loosely on the soil surface. Wooden stakes, reinforcement bars, or staples may be used as anchors in accordance with the details in the plans and as directed. Place anchors across the matting at the ends approximately 1 ft. apart. Place anchors along the outer edges and down the center of the matting 3 ft. apart.

All bare side slope sections of the skimmer basin shall be seeded with a temporary or permanent seed mix as directed and in accordance with Articles 1620-3, 1620-4, 1620-5, 1660-4, 1660-5 and 1660-7 of the *Standard Specifications*. Straw or excelsior matting shall be installed on all bare side slope sections immediately upon the completion of seeding and in accordance with Article 1631-3 of the *Standard Specifications*.

### **Measurement and Payment**

*Silt Excavation* will be measured and paid for in accordance with Article 1630-4 of the *Standard Specifications*, as calculated from the typical section throughout the length of the basin as shown on the final approved plans.

*Geotextile for Soil Stabilization* will be measured and paid for in accordance with Article 270-4 of the *Standard Specifications*.

*Coir Fiber Baffles* will be measured and paid for in accordance with Article 1640-4 of the *Standard Specifications*.

\_\_\_" *Skimmer* will be measured in units of each. \_\_\_" *Skimmer* will be measured and paid for as the maximum number of each size skimmer acceptably installed and in use at any one time during the life of the project. Barrel and arm pipe, cleanout, relocation and reinstallation of \_\_\_" *Skimmer* is considered incidental to the measurement of the quantity of \_\_\_" *Skimmer* and no separate payment will be made. No separate payment shall be made if \_\_\_" *Skimmer*, barrel and/or arm pipe(s) are damaged by ice accumulation.

*Coir Fiber Mat* will be measured and paid for as the actual number of square yards measured along the surface of the ground over which coir fiber mat is installed and accepted.

*Temporary Slope Drain* will be measured and paid for in accordance with Article 1622-4 of the *Standard Specifications*.

*Stone for Erosion Control, Class \_\_\_* will be measured and paid for in accordance with Article 1610-4 of the *Standard Specifications*.

*Seeding and Mulching* will be measured and paid for in accordance with Article 1660-8 of the *Standard Specifications*.

*Seed for Temporary Seeding* will be measured and paid for in accordance with Article 1620-6 of the *Standard Specifications*.

*Fertilizer for Temporary Seeding* will be measured and paid for in accordance with Article 1620-6 of the *Standard Specifications*.

*Matting for Erosion Control* will be measured and paid for in accordance with Article 1631-4 of the *Standard Specifications*.

No measurement will be made for other items or for over excavation or stockpiling.

Payment will be made under:

<b>Pay Item</b>	<b>Pay Unit</b>
___" Skimmer	Each
Coir Fiber Mat	Square Yard

**WATTLES WITH POLYACRYLAMIDE (PAM):**

**Description**

Wattles are tubular products consisting of excelsior fibers encased in synthetic netting. Wattles are used on slopes or channels to intercept runoff and act as a velocity break. Wattles are to be placed at locations shown on the plans or as directed. Installation shall follow the detail provided in the plans and as directed. Work includes furnishing materials, installation of wattles, matting installation, PAM application, and removing wattles.

**Materials**

Wattle shall meet the following specifications:

- 100% Curled Wood (Excelsior) Fibers
- Minimum Diameter      12 in.
- Minimum Density        2.5 lb/ft<sup>3</sup> +/- 10%



Net Material	Synthetic
Net Openings	1 in. x 1 in.
Net Configuration	Totally Encased
Minimum Weight	20 lb. +/- 10% per 10 ft. length

Anchors: Stakes shall be used as anchors.

#### Wooden Stakes:

Provide hardwood stakes a minimum of 2-ft. long with a 2 in. x 2 in. nominal square cross section. One end of the stake must be sharpened or beveled to facilitate driving down into the underlying soil.

Matting shall meet the requirements of Article 1060-8 of the *Standard Specifications*, or shall meet specifications provided elsewhere in this contract.

Provide staples made of 0.125" diameter new steel wire formed into a *u* shape not less than 12" in length with a throat of 1" in width.

Polyacrylamide (PAM) shall be applied in powder form and shall be anionic or neutrally charged. Soil samples shall be obtained in areas where the wattles will be placed, and from offsite material used to construct the roadway, and analyzed for the appropriate PAM flocculant to be utilized with each wattle. The PAM product used shall be listed on the North Carolina Department of Environment and Natural Resources (NCDENR) Division of Water Quality (DWQ) web site as an approved PAM product for use in North Carolina.

### Construction Methods

Wattles shall be secured to the soil by wire staples approximately every 1 linear foot and at the end of each section of wattle. A minimum of 4 stakes shall be installed on the downstream side of the wattle with a maximum spacing of 2 linear feet along the wattle, and according to the detail. Install a minimum of 2 stakes on the upstream side of the wattle according to the detail provided in the plans. Stakes shall be driven into the ground a minimum of 10 in. with no more than 2 in. projecting from the top of the wattle. Drive stakes at an angle according to the detail provided in the plans.

Only install wattle(s) to a height in ditch so flow will not wash around wattle and scour ditch slopes and according to the detail provided in the plans and as directed. Overlap adjoining sections of wattles a minimum of 6 in.

Installation of matting shall be in accordance with the detail provided in the plans, and in accordance with Article 1631-3 of the *Standard Specifications*, or in accordance with specifications provided elsewhere in this contract.

Apply PAM over the lower center portion of the wattle where the water is going to flow over at a rate of 2 ounces per wattle, and 1 ounce of PAM on matting on each side of the wattle. PAM

applications shall be done during construction activities after every rainfall event that is equal to or exceeds 0.50 in.

The Contractor shall maintain the wattles until the project is accepted or until the wattles are removed, and shall remove and dispose of silt accumulations at the wattles when so directed in accordance with the requirements of Section 1630 of the *Standard Specifications*.

### Measurement and Payment

*Wattles* will be measured and paid for by the actual number of linear feet of wattles which are installed and accepted. Such price and payment will be full compensation for all work covered by this section, including, but not limited to, furnishing all materials, labor, equipment and incidentals necessary to install the *Wattles*.

Matting will be measured and paid for in accordance with Article 1631-4 of the *Standard Specifications*, or in accordance with specifications provided elsewhere in this contract.

*Polyacrylamide(PAM)* will be measured and paid for by the actual weight in pounds of PAM applied to the wattles. Such price and payment will be full compensation for all work covered by this section, including, but not limited to, furnishing all materials, labor, equipment and incidentals necessary to apply the *Polyacrylamide(PAM)*.

Payment will be made under:

<b>Pay Item</b>	<b>Pay Unit</b>
Polyacrylamide(PAM)	Pound
Wattle	Linear Foot

### **TEMPORARY ROCK SILT CHECK TYPE A WITH EXCELSIOR MATTING AND POLYACRYLAMIDE (PAM):**

#### **Description**

Temporary Rock Silt Checks Type A with Excelsior Matting and Polyacrylamide (PAM) are devices utilized in temporary and permanent ditches to reduce runoff velocity and incorporate PAM into the construction runoff to increase settling of sediment particles and reduce turbidity of runoff. Temporary Rock Silt Checks Type A with Excelsior Matting and PAM are to be placed at locations shown on the plans or as directed. Installation shall follow the detail provided in the plans and as directed. Work includes furnishing materials, installation of Temporary Rock Silt Checks Type A, matting installation, PAM application, and removing Temporary Rock Silt Checks Type A with Excelsior Matting and PAM.

#### **Materials**

Structural stone shall be class B stone that meets the requirements of Section 1042 of the *Standard Specifications* for Stone for Erosion Control, Class B.

Sediment control stone shall be #5 or #57 stone, which meets the requirements of Section 1005 of the *Standard Specifications* for these stone sizes.

Matting shall meet the requirements of Excelsior Matting in Subarticle 1060-8(B) of the *Standard Specifications*, or shall meet specifications provided elsewhere in this contract.

Polyacrylamide (PAM) shall be applied in powder form and shall be anionic or neutrally charged. Soil samples shall be obtained in areas where the Temporary Rock Silt Checks Type A with Excelsior Matting and PAM will be placed, and from offsite material used to construct the roadway, and analyzed for the appropriate PAM flocculant to be utilized with each Temporary Rock Silt Check Type A. The PAM product used shall be listed on the North Carolina Department of Environment and Natural Resources (NCDENR) Division of Water Quality (DWQ) web site as an approved PAM product for use in North Carolina.

### **Construction Methods**

Temporary Rock Silt Checks Type A shall be installed in accordance with Subarticle 1633-3(A) of the *Standard Specifications*, Roadway Standard Drawing No. 1633.01 and the detail provided in the plans.

Installation of matting shall be in accordance with the detail provided in the plans, and anchored by placing Class B stone on top of the matting at the upper and lower ends.

Apply PAM at a rate of 4 ounces over the center portion of the Temporary Rock Silt Checks Type A and matting where the water is going to flow over. PAM applications shall be done during construction activities and after every rainfall event that is equal to or exceeds 0.50 in.

The Contractor shall maintain the Temporary Rock Silt Checks Type A with Excelsior Matting and PAM until the project is accepted or until the Temporary Rock Silt Checks Type A with Excelsior Matting and PAM are removed, and shall remove and dispose of silt accumulations at the Temporary Rock Silt Checks Type A with Excelsior Matting and PAM when so directed in accordance with the requirements of Section 1630 of the *Standard Specifications*.

### **Measurement and Payment**

*Temporary Rock Silt Checks Type A* will be measured and paid for in accordance with Article 1633-5 of the *Standard Specifications*, or in accordance with specifications provided elsewhere in this contract.

Matting will be measured and paid for in accordance with Article 1631-4 of the *Standard Specifications*, or in accordance with specifications provided elsewhere in this contract.

*Polyacrylamide(PAM)* will be measured and paid for by the actual weight in pounds of PAM applied to the Temporary Rock Silt Checks Type A. Such price and payment will be full compensation for all work covered by this section, including, but not limited to, furnishing all materials, labor, equipment and incidentals necessary to apply the *Polyacrylamide(PAM)*.

Payment will be made under:

<b>Pay Item</b>	<b>Pay Unit</b>
Polyacrylamide(PAM)	Pound

### **CULVERT DIVERSION CHANNEL:**

#### **Description**

This work consists of providing a *Culvert Diversion Channel* to detour the existing stream around the culvert construction site at locations shown on the plans. Work includes constructing the diversion channel, disposing of excess materials, providing and placing geotextile liner, maintaining the diversion area in an acceptable condition, removing geotextile liner, backfilling diversion channel area with suitable material, and providing proper drainage when diversion channel area is abandoned.

#### **Materials**

Refer to Division 10

<b>Item</b>	<b>Section</b>
Geotextile for Soil Stabilization, Type 4	1056

#### **Construction Methods**

Grade channel according to the plans with channel surface free of obstructions, debris, and pockets of low-density material. Utilize suitable material and provide disposal area for unsuitable material.

Line channel with geotextile unrolled in the direction of flow and lay smoothly but loosely on soil surface without creases. Bury top of slope geotextile edge in a trench at least 5" deep and tamp securely. Make vertical overlaps a minimum of 18" with upstream geotextile overlapping the downstream geotextile.

Secure geotextile with eleven gauge wire staples shaped into a *u* shape with a length of not less than 6" and a throat not less than 1" in width. Place staples along outer edges and throughout the geotextile a maximum of 3 ft. horizontally and vertically.

#### **Measurement and Payment**

*Culvert Diversion Channel* will be measured and paid for as the actual number of cubic yards excavated, as calculated from the typical section throughout the length of the diversion channel as shown on the final approved plans.

*Geotextile for Soil Stabilization* will be measured and paid for in accordance with Article 270-4 of the *Standard Specifications*.

Such price and payment shall be considered full compensation for all work covered by this section including all materials, construction, maintenance, and removal of *Culvert Diversion Channel*.

Payment will be made under:

<b>Pay Item</b>	<b>Pay Unit</b>
Culvert Diversion Channel	Cubic Yard

### **IMPERVIOUS DIKE:**

#### **Description**

This work consists of furnishing, installing, maintaining, and removing an *Impervious Dike* for the purpose of diverting normal stream flow around the construction site. The Contractor shall construct an impervious dike in such a manner approved by the Engineer. The impervious dike shall not permit seepage of water into the construction site or contribute to siltation of the stream. The impervious dike shall be constructed of an acceptable material in the locations noted on the plans or as directed.

#### **Materials**

Acceptable materials shall include but not be limited to sheet piles, sandbags, and/or the placement of an acceptable size stone lined with polypropylene or other impervious geotextile.

Earth material shall not be used to construct an impervious dike when it is in direct contact with the stream unless vegetation can be established before contact with the stream takes place.

#### **Measurement and Payment**

*Impervious Dike* will be measured and paid as the actual number of linear feet of impervious dike(s) constructed, measured in place from end to end of each separate installation that has been completed and accepted. Such price and payment will be full compensation for all work including but not limited to furnishing materials, construction, maintenance, and removal of the impervious dike.

Payment will be made under:

<b>Pay Item</b>	<b>Pay Unit</b>
Impervious Dike	Linear Foot

**COIR FIBER MAT:****Description**

Furnish material, install and maintain coir fiber mat in locations shown on the plans or in locations as directed. Work includes providing all materials, excavating and backfilling, and placing and securing coir fiber mat with stakes, steel reinforcement bars or staples as directed.

**Materials**

<b>Item</b>	<b>Section</b>
Coir Fiber Mat	1060-14

Anchors: Stakes, reinforcement bars, or staples shall be used as anchors.

**Wooden Stakes:**

Provide hardwood stakes 12"- 24" long with a 2" x 2" nominal square cross section. One end of the stake must be sharpened or beveled to facilitate driving through the coir fiber mat and down into the underlying soil. The other end of the stake needs to have a 1"- 2" long head at the top with a 1"- 2" notch following to catch and secure the coir fiber mat.

**Steel Reinforcement Bars:**

Provide uncoated #10 steel reinforcement bars 24" nominal length. The bars shall have a 4" diameter bend at one end with a 4" straight section at the tip to catch and secure the coir fiber mat.

**Staples:**

Provide staples made of 0.125" diameter new steel wire formed into a *u* shape not less than 12" in length with a throat of 1" in width.

**Construction Methods**

Place the coir fiber mat immediately upon final grading. Provide a smooth soil surface free from stones, clods, or debris that will prevent the contact of the mat with the soil. Unroll the mat and apply without stretching such that it will lie smoothly but loosely on the soil surface.

For stream relocation applications, take care to preserve the required line, grade, and cross section of the area covered. Bury the top slope end of each piece of mat in a narrow trench at least 6 in. deep and tamp firmly. Where one roll of matting ends and a second roll begins, overlap the end of the upper roll over the buried end of the second roll so there is a 6 in. overlap. Construct check trenches at least 12 in. deep every 50 ft. longitudinally along the edges of the mat or as directed. Fold over and bury mat to the full depth of the trench, close and tamp firmly. Overlap mat at least 6 in. where 2 or more widths of mat are installed side by side.

Place anchors across the mat at the ends approximately 1 ft. apart. Place anchors along the outer edges and down the center of the mat 3 ft. apart.

Adjustments in the trenching or anchoring requirements to fit individual site conditions may be required.

### **Measurement and Payment**

*Coir Fiber Mat* will be measured and paid for as the actual number of square yards measured along the surface of the ground over which coir fiber mat is installed and accepted.

No measurement will be made for anchor items.

Payment will be made under:

<b>Pay Item</b>	<b>Pay Unit</b>
Coir Fiber Mat	Square Yard

### **CONCRETE WASHOUT STRUCTURE:**

(12-01-15)

#### **Description**

Concrete washout structures are enclosures above or below grade to contain concrete waste water and associated concrete mix from washing out ready-mix trucks, drums, pumps, or other equipment. Concrete washouts must collect and retain all the concrete washout water and solids, so that this material does not migrate to surface waters or into the ground water. These enclosures are not intended for concrete waste not associated with wash out operations.

The concrete washout structure may include constructed devices above or below ground and or commercially available devices designed specifically to capture concrete waste water.

#### **Materials**

<b>Item</b>	<b>Section</b>
Temporary Silt Fence	1605

*Safety Fence* shall meet the specifications as provided elsewhere in this contract.

Geomembrane basin liner shall meet the following minimum physical properties for low permeability; it shall consist of a polypropylene or polyethylene 10 mil thick geomembrane. If the minimum setback dimensions can be achieved the liner is not required. (5 feet above groundwater, 50 feet from top of bank of perennial stream, other surface water body, or wetland.)

### **Construction Methods**

Build an enclosed earthen berm or excavate to form an enclosure in accordance with the details and as directed.

Install temporary silt fence around the perimeter of the enclosure in accordance with the details and as directed if structure is not located in an area where existing erosion and sedimentation control devices are capable to containing any loss of sediment.

Post a sign with the words “Concrete Washout” in close proximity of the concrete washout area, so it is clearly visible to site personnel.

The construction details for the above grade and below grade concrete washout structures can be found on the following web page link:

[http://www.ncdot.gov/doh/operations/dp\\_chief\\_eng/roadside/soil\\_water/details/](http://www.ncdot.gov/doh/operations/dp_chief_eng/roadside/soil_water/details/)

[Alternate details for accommodating concrete washout may be submitted for review and approval.](#)

[The alternate details shall include the method used to retain and dispose of the concrete waste water within the project limits and in accordance with the minimum setback requirements.](#) (5 feet above groundwater, 50 feet from top of bank of perennial stream, other surface water body, or wetland.)

### **Maintenance and Removal**

Maintain the concrete washout structure(s) to provide adequate holding capacity plus a minimum freeboard of 12 inches. Remove and dispose of hardened concrete and return the structure to a functional condition after reaching 75% capacity.

Inspect concrete washout structures for damage and maintain for effectiveness.

Remove the concrete washout structures and sign upon project completion. Grade the earth material to match the existing contours and permanently seed and mulch area.

### **Measurement and Payment**

*Concrete Washout Structure* will be paid for per each enclosure installed in accordance with the details. If alternate details are approved then those details will also be paid for per each approved and installed device.

*Temporary Silt Fence* will be measured and paid for in accordance with Article 1605-5 of the *Standard Specifications*.

No measurement will be made for other items or for over excavation or stockpiling.



Payment will be made under:

**Pay Item**

Concrete Washout Structure

**Pay Unit**

Each

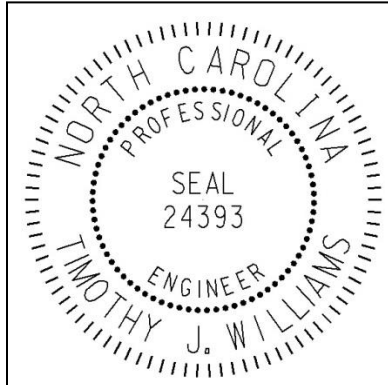

**Signals and Intelligent Transportation Systems  
Project Special Provisions  
(Version 12.4)**

Prepared By: M. Mahbooba  
2-Oct-15

DocuSigned by:

10/2/2015

*J. J. Williams*

97AD792F85934CA

**Contents**

**I. 2012 STANDARD SPECIFICATIONS FOR ROADS & STRUCTURES.....2**

1.1. POLYMER CONCRETE (PC) JUNCTION BOXES (1091-5(B)).....2

1.2. SUBMITTAL REQUIREMENTS (1098-1(B)) .....2

1.3. JUNCTION BOXES (1098-5).....2

1.4. CONTROLLERS WITH CABINETS – MATERIAL (1751-2) .....2

1.5. PEDESTALS (1743) .....2

**2. SIGNAL HEADS.....3**

2.1. MATERIALS .....3

A. *General:*.....3

B. *Vehicle Signal Heads:*.....5

C. *Signal Cable:* .....8

**3. CONTROLLERS WITH CABINETS .....8**

3.1. MATERIALS – TYPE 2070L CONTROLLERS .....8

3.2. MATERIALS – GENERAL CABINETS .....9

3.3. MATERIALS – TYPE 170E CABINETS .....10

A. *Type 170 E Cabinets General:*.....10

B. *Type 170 E Cabinet Electrical Requirements:*.....10

C. *Type 170 E Cabinet Physical Requirements:*.....18

D. *Model 2018 Enhanced Conflict Monitor:* .....20

E. *Preemption and Sign Control Box* .....30

3.4. MATERIALS – TYPE 170 DETECTOR SENSOR UNITS .....33

3.5. MATERIALS – TYPE 2070E CONTROLLERS .....33

**4. GPS UNIT .....33**

4.1. DESCRIPTION .....33

4.2. MATERIALS .....33

4.3. CONSTRUCTION METHODS .....33

4.4. MEASUREMENT AND PAYMENT .....34

**5. RELOCATE SCHOOL FLASHER .....34**

5.1. DESCRIPTION .....34

5.2. MATERIALS .....34

5.3. CONSTRUCTION METHODS .....34

5.4. MEASUREMENT AND PAYMENT .....34

**1. 2012 STANDARD SPECIFICATIONS FOR ROADS & STRUCTURES**

*The 2012 Standard Specifications are revised as follows:*

**1.1. Polymer Concrete (PC) Junction Boxes (1091-5(B))**

Page 10-202, revise paragraph starting on line 9 to read “Provide polymer concrete (PC) boxes which have bolted covers and open bottoms. Provide vertical extensions of 6" to 12" as required by project special provisions.”

Page 10-202, revise sentence beginning on line 14 to read “Other thermoplastic materials may be used for components which are not normally exposed to sunlight.”

**1.2. Submittal Requirements (1098-1(B))**

Page 10-208, replace paragraph on line 34 with the following:

Submit for approval catalog cuts and/or shop drawings for materials proposed for use on the project. Allow 40 days for review of each submittal. Do not fabricate or order material until receipt of Engineer’s approval.

Submit 4 copies of each catalog cut and/or drawing and show for each component the material description, brand name, stock-number, size, rating, manufacturing specification and the intended use (identified by labeling all components with the corresponding contract line item number). Present the submittals neatly arranged in the same order as the contract bid items. Electronic submittals of catalog cuts and drawings may be accepted in lieu of hard copies.

One hard copy and an electronic (PDF) copy of reviewed submittals will be returned to the Engineer from the ITS and Signals Unit.

**1.3. Junction Boxes (1098-5)**

Page 10-212, sub-Section 1098-5(C) Oversized Junction Boxes

Revise sentence to read, “Provide oversized junction boxes and covers with minimum inside dimensions of 28"(l) x 15"(w) x 22"(h).”

**1.4. Controllers with Cabinets – Material (1751-2)**

Page 17-37, Section 1751-2 Material

Add the following paragraph:

When the plans or specifications require a Type 2070L controller, contractor may provide a Type 2070E controller. Unless otherwise allowed by the Engineer, provide controllers of only one type.

**1.5. Pedestals (1743)**

Page 17-34, Add the following new sub-Section:

**1743-4 - Screw-In Helical Foundation Anchor Assembly****Description:**

Furnish and install screw-in helical foundation as an alternative to the standard reinforced concrete foundation specified in Article 1743 “Pedestals” of the Standard Specifications, for supporting Type I and Type II Pedestals. Do not use for Type III Pedestals.

**Materials for Type I – Pedestrian Pushbutton Post:**

Fabricate pipe assembly consisting of a 4” diameter x 56” long pipe, single helical blade and square fixed attachment plate. Furnish pipe in accordance with ASTM A-53 ERW Grade B and include a 2” x 3” cable opening in the pipe at 18” below the attachment plate. Furnish steel attachment plate and

helical blade in accordance with ASTM A-36. Include (4) slotted mounting holes in the attachment plate to fit bolt circles ranging from 7-3/4" to 14-3/4" diameter. Furnish additional 3/4" keyholes at slotted holes to permit anchor bolt installation and replacement from top surface. Include combination bolt-head retainer and dirt scrapers at the attachment plate underside to allow for a level or flush-mount plate installation with respect to the finished grade. Galvanize pipe assembly components in accordance with AASHTO M 111 or an approved equivalent.

Furnish (4) 3/4"-10NC x 3" square head anchor bolts to meet the requirements of ASTM 325. Provide (4) 3/4" plain flat galvanized washers, (4) 3/16" thick galvanized plate washers and (4) 3/4" galvanized hex nuts. Galvanize in accordance with AASHTO M 111 or an approved equivalent.

#### **Construction Methods for Type I – Pedestrian Pushbutton Post:**

Advance or mechanically screw foundation into soil up until top of attachment plate is level with finished grade. Slide the anchor bolt heads through the keyhole openings and under the attachment plate with threads pointing up. Bolt the pedestal base to the foundation attachment plate. For further construction methods, see manufacturer's installation drawings.

#### **Materials for Type II – Normal-Duty Pedestal:**

Fabricate pipe assembly consisting of a 6" diameter x 60" long, single helical blade, 1-1/4" diameter stinger rod and square fixed attachment plate. Furnish pipe in accordance with ASTM A-53 ERW Grade B using schedule 40 wall thickness and include a 2" x 3" cable opening in the pipe at 18" below the attachment plate. Furnish steel attachment plate, helical blade and stinger rod in accordance with ASTM A-36. Include (4) slotted mounting holes in the attachment plate to fit bolt circles ranging from 10" to 15" diameter. Furnish additional 1-1/4" keyholes at slotted holes to permit anchor bolt installation and replacement from top surface. Include combination bolt-head retainer and dirt scrapers at the attachment plate underside to allow for a level or flush-mount plate installation with respect to the finished grade. Galvanize pipe assembly components in accordance with AASHTO M 111 or an approved equivalent.

Furnish (4) 1"-8NC x 4" galvanized Grade 5 square head anchor bolts. Provide (4) 1" plain flat galvanized washers and (4) 1" galvanized hex nuts. Galvanize in accordance with AASHTO M 111 or an approved equivalent.

#### **Construction Methods for Type II – Normal-Duty Pedestal:**

Advance or mechanically screw foundation into soil up until top of attachment plate is level with finished grade. Slide the anchor bolt heads through the keyhole openings and under the attachment plate with threads pointing up. Bolt the pedestal base to the foundation attachment plate.

For further construction methods, see manufacturer's installation drawings.

Page 17-34, revise Measurement and Payment to sub-Section 1743-5.

Revise the last paragraph to read:

No measurement will be made for pedestal foundations, pedestal screw-in helical foundations, grounding systems and any peripheral pedestal mounting hardware as these are incidental to furnishing and installing pedestals.

## **2. SIGNAL HEADS**

### **2.1. MATERIALS**

#### **A. General:**

Fabricate vehicle signal head housings and end caps from die-cast aluminum. Fabricate 12-inch and 16-inch pedestrian signal head housings and end caps from die-cast aluminum. Fabricate 9-inch

pedestrian signal head housings, end caps, and visors from virgin polycarbonate material. Provide visor mounting screws, door latches, and hinge pins fabricated from stainless steel. Provide interior screws, fasteners, and metal parts fabricated from stainless steel or corrosion resistant material.

Fabricate tunnel and traditional visors from sheet aluminum.

Paint all surfaces inside and outside of signal housings and doors. Paint outside surfaces of tunnel and traditional visors, messenger cable mounting assemblies, pole and pedestal mounting assemblies, and pedestrian pushbutton housings. Have electrostatically-applied, fused-polyester paint in highway yellow (Federal Standard 595C, Color Chip Number 13538) a minimum of 2.5 to 3.5 mils thick. Do not apply paint to the latching hardware or rigid vehicle signal head mounting brackets for mast-arm attachments.

Have the interior surfaces of tunnel and traditional visors painted an alkyd urea black synthetic baking enamel with a minimum gloss reflectance and meeting the requirements of MIL-E-10169, "Enamel Heat Resisting, Instrument Black."

Where required, provide polycarbonate signal heads and visors that comply with the provisions pertaining to the aluminum signal heads listed on the QPL with the following exceptions:

Fabricate signal head housings, end caps, and visors from virgin polycarbonate material. Provide UV stabilized polycarbonate plastic with a minimum thickness of  $0.1 \pm 0.01$  inches that is highway yellow (Federal Standard 595C, Color Chip 13538). Ensure the color is incorporated into the plastic material before molding the signal head housings and end caps. Ensure the plastic formulation provides the following physical properties in the assembly (tests may be performed on separately molded specimens):

Test	Required	Method
Specific Gravity	1.17 minimum	ASTM D 792
Flammability	Self-extinguishing	ASTM D 635
Tensile Strength, yield, PSI	8500 minimum	ASTM D 638
Izod impact strength, ft-lb/in [notched, 1/8 inch]	12 minimum	ASTM D 256

For pole mounting, provide side of pole mounting assemblies with framework and all other hardware necessary to make complete, watertight connections of the signal heads to the poles and pedestals. Fabricate the mounting assemblies and frames from aluminum with all necessary hardware, screws, washers, etc. to be stainless steel. Provide mounting fittings that match the positive locking device on the signal head with the serrations integrally cast into the brackets. Provide upper and lower pole plates that have a 1 ¼-inch vertical conduit entrance hubs with the hubs capped on the lower plate and 1 ½-inch horizontal hubs. Ensure that the assemblies provide rigid attachments to poles and pedestals so as to allow no twisting or swaying of the signal heads. Ensure that all raceways are free of sharp edges and protrusions, and can accommodate a minimum of ten Number 14 AWG conductors.

For pedestal mounting, provide a post-top slipfitter mounting assembly that matches the positive locking device on the signal head with serrations integrally cast into the slipfitter. Provide stainless steel hardware, screws, washers, etc. Provide a minimum of six 3/8 X 3/4-inch long square head bolts for attachment to pedestal. Provide a center post for multi-way slipfitters.

For light emitting diode (LED) traffic signal modules, provide the following requirements for inclusion on the Department's Qualified Products List for traffic signal equipment.

1. Sample submittal,
2. Third-party independent laboratory testing results for each submitted module with evidence of testing and conformance with all of the Design Qualification Testing specified in section 6.4 of each of the following Institute of Transportation Engineers (ITE) specifications:
  - Vehicle Traffic Control Signal Heads – Light Emitting Diode (LED) Circular Signal Supplement
  - Vehicle Traffic Control Signal Heads – Light Emitting Diode (LED) Vehicle Arrow Traffic Signal Supplement
  - Pedestrian Traffic Control Signal Indications –Light Emitting Diode (LED) Signal Modules.

(Note: The Department currently recognizes two approved independent testing laboratories. They are Intertek ETL Semko and Light Metrics, Incorporated with Garwood Laboratories. Independent laboratory tests from other laboratories may be considered as part of the QPL submittal at the discretion of the Department,

3. Evidence of conformance with the requirements of these specifications,
4. A manufacturer’s warranty statement in accordance with the required warranty, and
5. Submittal of manufacturer’s design and production documentation for the model, including but not limited to, electrical schematics, electronic component values, proprietary part numbers, bill of materials, and production electrical and photometric test parameters.
6. Evidence of approval of the product to bear the Intertek ETL Verified product label for LED traffic signal modules.

In addition to meeting the performance requirements for the minimum period of 60 months, provide a written warranty against defects in materials and workmanship for the modules for a period of 60 months after installation of the modules. During the warranty period, the manufacturer must provide new replacement modules within 45 days of receipt of modules that have failed at no cost to the State. Repaired or refurbished modules may not be used to fulfill the manufacturer’s warranty obligations. Provide manufacturer’s warranty documentation to the Department during evaluation of product for inclusion on Qualified Products List (QPL).

#### **B. Vehicle Signal Heads:**

Comply with the ITE standard “Vehicle Traffic Control Signal Heads”. Provide housings with provisions for attaching backplates.

Provide visors that are 8 inches in length for 8-inch vehicle signal head sections. Provide visors that are 10 inches in length for 12-inch vehicle signal heads.

Provide a termination block with one empty terminal for field wiring for each indication plus one empty terminal for the neutral conductor. Have all signal sections wired to the termination block. Provide barriers between the terminals that have terminal screws with a minimum Number 8 thread size and that will accommodate and secure spade lugs sized for a Number 10 terminal screw.

Mount termination blocks in the yellow signal head sections on all in-line vehicle signal heads. Mount the termination block in the red section on five-section vehicle signal heads.

Furnish vehicle signal head interconnecting brackets. Provide one-piece aluminum brackets less than 4.5 inches in height and with no threaded pipe connections. Provide hand holes on the bottom of the brackets to aid in installing wires to the signal heads. Lower brackets that carry no wires and are used only for connecting the bottom signal sections together may be flat in construction.

For messenger cable mounting, provide messenger cable hangers, wire outlet bodies, balance adjusters, bottom caps, wire entrance fitting brackets, and all other hardware necessary to make complete, watertight connections of the vehicle signal heads to the messenger cable. Fabricate mounting assemblies from malleable iron or steel and provide serrated rings made of aluminum. Provide messenger cable hangers and balance adjusters that are galvanized before being painted. Fabricate balance adjuster eyebolt and eyebolt nut from stainless steel or galvanized malleable iron. Provide messenger cable hangers with U-bolt clamps. Fabricate washers, screws, bolts, clevis pins, cotter pins, nuts, and U-bolt clamps from stainless steel.

For mast-arm mounting, provide rigid vehicle signal head mounting brackets and all other hardware necessary to make complete, watertight connections of the vehicle signal heads to the mast arms and to provide a means for vertically adjusting the vehicle signal heads to proper alignment. Fabricate the mounting assemblies from aluminum, and provide serrated rings made of aluminum. Provide stainless steel cable attachment assemblies to secure the brackets to the mast arms. Ensure all fastening hardware and fasteners are fabricated from stainless steel.

Provide LED vehicular traffic signal modules (hereafter referred to as modules) that consist of an assembly that uses LEDs as the light source in lieu of an incandescent lamp for use in traffic signal sections. Use LEDs that are aluminum indium gallium phosphorus (AlInGaP) technology for red and yellow indications and indium gallium nitride (InGaN) for green indications. Install the ultra bright type LEDs that are rated for 100,000 hours of continuous operation from -40°F to +165°F. Design modules to have a minimum useful life of 60 months and to meet all parameters of this specification during this period of useful life.

For the modules, provide spade terminals crimped to the lead wires and sized for a #10 screw connection to the existing terminal block in a standard signal head. Do not provide other types of crimped terminals with a spade adapter.

Ensure the power supply is integral to the module assembly. On the back of the module, permanently mark the date of manufacture (month & year) or some other method of identifying date of manufacture.

Tint the red, yellow and green lenses to correspond with the wavelength (chromaticity) of the LED. Transparent tinting films are unacceptable. Provide a lens that is integral to the unit with a smooth outer surface.

### **1. LED Circular Signal Modules:**

Provide modules in the following configurations: 12-inch circular sections, and 8-inch circular sections. All makes and models of LED modules purchased for use on the State Highway System shall appear on the current NCDOT Traffic Signal Qualified Products List (QPL).

Provide the manufacturer's model number and the product number (assigned by the Department) for each module that appears on the 2012 or most recent Qualified Products List. In addition, provide manufacturer's certification in accordance with Article 106-3 of the *Standard Specifications*, that each module meets or exceeds the ITE "Vehicle Traffic Control Signal Heads – Light Emitting

Diode (LED) Circular Signal Supplement” dated June 27, 2005 (hereafter referred to as VTCSH Circular Supplement) and other requirements stated in this specification.

Provide modules that meet the following requirements when tested under the procedures outlined in the VTCSH Circular Supplement:

Module Type	Max. Wattage at 165° F	Nominal Wattage at 77° F
12-inch red circular	17	11
8-inch red circular	13	8
12-inch green circular	15	15
8-inch green circular	12	12

For yellow circular signal modules, provide modules tested under the procedures outlined in the VTCSH Circular Supplement to insure power required at 77° F is 22 Watts or less for the 12-inch circular module and 13 Watts or less for the 8-inch circular module.

Note: Use a wattmeter having an accuracy of  $\pm 1\%$  to measure the nominal wattage and maximum wattage of a circular traffic signal module. Power may also be derived from voltage, current and power factor measurements.

## 2. LED Arrow Signal Modules

Provide 12-inch omnidirectional arrow signal modules. All makes and models of LED modules purchased for use on the State Highway System shall appear on the current NCDOT Traffic Signal Qualified Products List (QPL).

Provide the manufacturer’s model number and the product number (assigned by the Department) for each module that appears on the 2012 or most recent Qualified Products List. In addition, provide manufacturer’s certification in accordance with Article 106-3 of the *Standard Specifications*, that each module meets or exceeds the requirements for 12-inch omnidirectional modules specified in the ITE “Vehicle Traffic Control Signal Heads – Light Emitting Diode (LED) Vehicle Arrow Traffic Signal Supplement” dated July 1, 2007 (hereafter referred to as VTCSH Arrow Supplement) and other requirements stated in this specification.

Provide modules that meet the following requirements when tested under the procedures outlined in the VTCSH Arrow Supplement:

Module Type	Max. Wattage at 165° F	Nominal Wattage at 77° F
12-inch red arrow	12	9
12-inch green arrow	11	11

For yellow arrow signal modules, provide modules tested under the procedures outlined in the VTCSH Arrow Supplement to insure power required at 77° F is 12 Watts or less.

Note: Use a wattmeter having an accuracy of  $\pm 1\%$  to measure the nominal wattage and maximum wattage of an arrow traffic signal module. Power may also be derived from voltage, current and power factor measurements.

## 3. LED U-Turn Arrow Signal Modules:

Provide modules in the following configurations: 12-inch left u-turn arrow signal modules and 12-inch right u-turn arrow signal modules.



Modules are not required to be listed on the ITS and Signals Qualified Products List. Provide manufacturer's certification in accordance with Article 106-3 of the *Standard Specifications*, that each module meets or exceeds the ITE "Vehicle Traffic Control Signal Heads – Light Emitting Diode (LED) Circular Signal Supplement" dated June 27, 2005 (hereafter referred to as VTCSH Circular Supplement) and other requirements stated in this specification.

Provide modules that have minimum maintained luminous intensity values that are not less than 16% of the values calculated using the method described in section 4.1 of the VTCSH Circular Supplement.

Provide modules that meet the following requirements when tested under the procedures outlined in the VTCSH Circular Supplement:

Module Type	Max. Wattage at 165° F	Nominal Wattage at 77° F
12-inch red u-turn arrow	17	11
12-inch green u-turn arrow	15	15

For yellow u-turn arrow signal modules, provide modules tested under the procedures outlined in the VTCSH Circular Supplement to ensure power required at 77° F is 22 Watts or less.

Note: Use a wattmeter having an accuracy of  $\pm 1\%$  to measure the nominal wattage and maximum wattage of a circular traffic signal module. Power may also be derived from voltage, current and power factor measurements.

### C. Signal Cable:

Furnish 16-4 and 16-7 signal cable that complies with IMSA specification 20-1 except provide the following conductor insulation colors:

- For 16-4 cable: white, yellow, red, and green
- For 16-7 cable: white, yellow, red, green, yellow with black stripe tracer, red with black stripe tracer, and green with black stripe tracer. Apply continuous stripe tracer on conductor insulation with a longitudinal or spiral pattern.

Provide a ripcord to allow the cable jacket to be opened without using a cutter. IMSA specification 19-1 will not be acceptable. Provide a cable jacket labeled with the IMSA specification number and provide conductors constructed of stranded copper.

## 3. CONTROLLERS WITH CABINETS

### 3.1. MATERIALS – TYPE 2070L CONTROLLERS

Conform to CALTRANS *Transportation Electrical Equipment Specifications (TEES)* (dated August 16, 2002, plus Errata 1 dated October 27, 2003 and Errata 2 dated June 08, 2004) except as required herein.

Furnish Model 2070L controllers. Ensure that removal of the CPU module from the controller will place the intersection into flash.

The Department will provide software at the beginning of the burning-in period. Contractor shall give 5 working days notice before needing software. Program software provided by the Department.

Provide model 2070L controllers with the latest version of OS9 operating software and device drivers, composed of the unit chassis and at a minimum the following modules and assemblies:

- MODEL 2070 1B, CPU Module, Single Board
- MODEL 2070-2A, Field I/O Module (FI/O)
  - Note: Configure the Field I/O Module to disable both the External WDT Shunt/Toggle Switch and SP3 (SP3 active indicator is “off”)
- MODEL 2070-3B, Front Panel Module (FP), Display B (8x40)
- MODEL 2070-4A, Power Supply Module, 10 AMP
- MODEL 2070-7A, Async Serial Com Module (9-pin RS-232)

Furnish one additional MODEL 2070-7A, Async Serial Com Module (9-pin RS-232) for all master controller locations.

For each master location and central control center, furnish a U.S. Robotics V.92 or approved equivalent auto-dial/auto-answer external modem to accomplish the interface to the Department-furnished microcomputers. Include all necessary hardware to ensure telecommunications.

### 3.2. MATERIALS – GENERAL CABINETS

Provide a moisture resistant coating on all circuit boards.

Provide one 20 mm diameter radial lead UL-recognized metal oxide varistor (MOV) between each load switch field terminal and equipment ground. Electrical performance is outlined below.

<b>PROPERTIES OF MOV SURGE PROTECTOR</b>	
Maximum Continuous Applied Voltage at 185° F	150 VAC (RMS) 200 VDC
Maximum Peak 8x20µs Current at 185° F	6500 A
Maximum Energy Rating at 185° F	80 J
Voltage Range 1 mA DC Test at 77° F	212-268 V
Max. Clamping Voltage 8x20µs, 100A at 77° F	395 V
Typical Capacitance (1 MHz) at 77° F	1600 pF

Provide a power line surge protector that is a two-stage device that will allow connection of the radio frequency interference filter between the stages of the device. Ensure that a maximum continuous current is at least 10A at 120V. Ensure that the device can withstand a minimum of 20 peak surge current occurrences at 20,000A for an 8x20 microsecond waveform. Provide a maximum clamp voltage of 395V at 20,000A with a nominal series inductance of 200µh. Ensure that the voltage does not exceed 395V. Provide devices that comply with the following:

Frequency (Hz)	Minimum Insertion Loss (dB)
60	0
10,000	30
50,000	55
100,000	50
500,000	50
2,000,000	60
5,000,000	40
10,000,000	20
20,000,000	25

### 3.3. MATERIALS – TYPE 170E CABINETS

#### A. Type 170 E Cabinets General:

Conform to the city of Los Angeles' Specification No. 54-053-08, *Traffic Signal Cabinet Assembly Specification* (dated July 2008), except as required herein.

Furnish model 336S pole mounted cabinets configured for 8 vehicle phases, 4 pedestrian phases, and 6 overlaps. Do not reassign load switches to accommodate overlaps unless shown on electrical details. Provide 336S pole mounted cabinets that are 46" high with 40" high internal rack assemblies.

Furnish model 332 base mounted cabinets configured for 8 vehicle phases, 4 pedestrian phases, and 6 overlaps. When overlaps are required, provide auxiliary output files for the overlaps. Do not reassign load switches to accommodate overlaps unless shown on electrical details.

Provide model 200 load switches, model 222 loop detector sensors, model 252 AC isolators, and model 242 DC isolators according to the electrical details. As a minimum, provide one (1) model 2018 conflict monitor, one (1) model 206L power supply unit, two (2) model 204 flashers, one (1) DC isolator (located in slot I14), and four (4) model 430 flash transfer relays (provide seven (7) model 430 flash transfer relays if auxiliary output file is installed) with each cabinet.

#### B. Type 170 E Cabinet Electrical Requirements:

Provide a cabinet assembly designed to ensure that upon leaving any cabinet switch or conflict monitor initiated flashing operation, the controller starts up in the programmed start up phases and start up interval.

Furnish two sets of non-fading cabinet wiring diagrams and schematics in a paper envelope or container and placed in the cabinet drawer.

All AC+ power is subject to radio frequency signal suppression.

Provide surge suppression in the cabinet for each type of cabinet device. Provide surge protection for the full capacity of the cabinet input file. Provide surge suppression devices that

operate properly over a temperature range of -40° F to +185° F. Ensure the surge suppression devices provide both common and differential modes of protection.

Provide a pluggable power line surge protector that is installed on the back of the PDA (power distribution assembly) chassis to filter and absorb power line noise and switching transients. Ensure the device incorporates LEDs for failure indication and provides a dry relay contact closure for the purpose of remote sensing. Ensure the device meets the following specifications:

Peak Surge Current (Single pulse, 8x20µs).....	20,000A
Occurrences (8x20µs waveform).....	10 minimum @ 20,000A
Maximum Clamp Voltage.....	395VAC
Operating Current.....	15 amps
Response Time.....	< 5 nanoseconds

Provide a loop surge suppressor for each set of loop terminals in the cabinet. Ensure the device meets the following specifications:

Peak Surge Current (6 times, 8x20µs)	
(Differential Mode).....	400A
(Common Mode).....	1,000A
Occurrences (8x20µs waveform).....	500 min @ 200A
Maximum Clamp Voltage	
(Differential Mode @400A).....	35V
(Common Mode @1,000A).....	35V
Response Time.....	< 5 nanoseconds
Maximum Capacitance.....	35 pF

Provide a data communications surge suppressor for each communications line entering or leaving the cabinet. Ensure the device meets the following specifications:

Peak Surge Current (Single pulse, 8x20µs).....	10,000A
Occurrences (8x20µs waveform).....	100 min @ 2,000A
Maximum Clamp Voltage.....	Rated for equipment protected
Response Time.....	< 1 nanosecond
Maximum Capacitance.....	1,500 pF
Maximum Series Resistance.....	15Ω

Provide a DC signal surge suppressor for each DC input channel in the cabinet. Ensure the device meets the following specifications:

- Peak Surge Current (Single pulse, 8x20µs).....10,000A
- Occurrences (8x20µs waveform).....100 @ 2,000A
- Maximum Clamp Voltage.....30V
- Response Time.....< 1 nanosecond

Provide a 120 VAC signal surge suppressor for each AC+ interconnect signal input. Ensure the device meets the following specifications:

- Peak Surge Current (Single pulse, 8x20µs).....20,000A
- Maximum Clamp Voltage.....350VAC
- Response Time.....< 200 nanoseconds
- Discharge Voltage.....<200 Volts @ 1,000A
- Insulation Resistance.....≥100 MΩ

Provide conductors for surge protection wiring that are of sufficient size (ampacity) to withstand maximum overcurrents which could occur before protective device thresholds are attained and current flow is interrupted.

If additional surge protected power outlets are needed to accommodate fiber transceivers, modems, etc., install a UL listed, industrial, heavy-duty type power outlet strip with a minimum rating of 15 A / 125 VAC, 60 Hz. Provide a strip that has a minimum of 3 grounded outlets. Ensure the power outlet strip plugs into one of the controller unit receptacles located on the rear of the PDA. Ensure power outlet strip is mounted securely; provide strain relief if necessary.

Provide a door switch in the front and a door switch in the rear of the cabinet that will provide the controller unit with a Door Ajar alarm when either the front or the rear door is open. Ensure the door switches apply DC ground to the Input File when either the front door or the rear door is open.

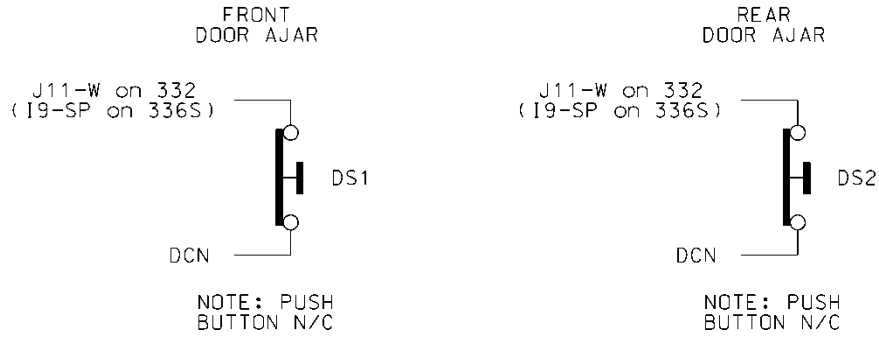

Furnish a fluorescent fixture in the rear across the top of the cabinet and another fluorescent fixture in the front across the top of the cabinet at a minimum. Ensure that the fixtures provide sufficient light to illuminate all terminals, labels, switches, and devices in the cabinet. Conveniently locate the fixtures so as not to interfere with a technician’s ability to perform work on any devices or terminals in the cabinet. Provide a protective diffuser to cover exposed bulbs. Install 16 watt T-4 lamps in the fluorescent fixtures. Provide a door switch to provide power to each fixture when the respective door is open. Wire the fluorescent fixtures to the 15 amp ECB (equipment circuit breaker).

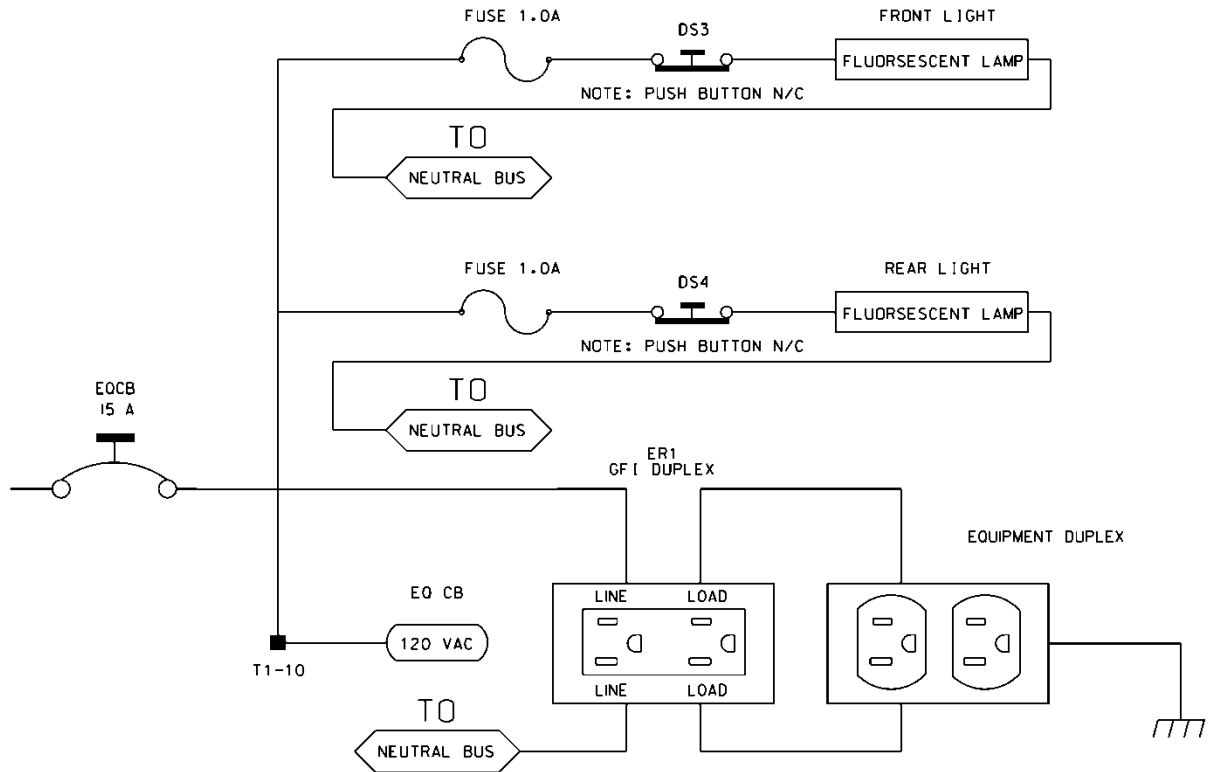

Furnish a police panel with a police panel door. For model 336S cabinets, mount the police panel on the rear door. Ensure that the police panel door permits access to the police panel when the main door is closed. Ensure that no rainwater can enter the cabinet even with the police panel door open. Provide a police panel door hinged on the right side as viewed from the front. Provide a police panel

door lock that is keyed to a standard police/fire call box key. In addition to the requirements of LA Specification No. 54-053-08, provide the police panel with a toggle switch connected to switch the intersection operation between normal stop-and-go operation (AUTO) and manual operation (MANUAL). Ensure that manual control can be implemented using inputs and software such that the controller provides full programmed clearance times for the yellow clearance and red clearance for each phase while under manual control.

Provide a 1/4-inch locking phone jack in the police panel for a hand control to manually control the intersection. Provide sufficient room in the police panel for storage of a hand control and cord.

Ensure the 336S cabinet Input File is wired as follows:

<b>336S Cabinet</b>														
<b>Port-Bit/C-1 Pin Assignment</b>														
Slot #	1	2	3	4	5	6	7	8	9	10	11	12	13	14
C-1 (Spares)	59	60	61	62	63	64	65	66	75	76	77	78	79	80
Port C-1	3-2	1-1	3-4	1-3	3-1	1-2	3-3	1-4	2-5	5-5	5-6	5-1	5-2	6-7
C-1	56	39	58	41	55	40	57	42	51	71	72	67	68	81
Port C-1	2-1	1-5	2-3	1-7	2-2	1-6	2-4	1-8	2-6	5-7	5-8	5-3	5-4	6-8
C-1	47	43	49	45	48	44	50	46	52	73	74	69	70	82

For model 332 base mounted cabinets, ensure terminals J14-E and J14-K are wired together on the rear of the Input File. Connect TB9-12 (J14 Common) on the Input Panel to T1-2 (AC-) on the rear of the PDA.

Provide detector test switches mounted at the top of the cabinet rack or other convenient location which may be used to place a call on each of eight phases based on the chart below. Provide three positions for each switch: On (place call), Off (normal detector operation), and Momentary On (place momentary call and return to normal detector operation after switch is released). Ensure that the switches are located such that the technician can read the controller display and observe the intersection.

Connect detector test switches for cabinets as follows:

336S Cabinet		332 Cabinet	
Detector Call Switches	Terminals	Detector Call Switches	Terminals
Phase 1	I1-F	Phase 1	I1-W
Phase 2	I2-F	Phase 2	I4-W
Phase 3	I3-F	Phase 3	I5-W
Phase 4	I4-F	Phase 4	I8-W
Phase 5	I5-F	Phase 5	J1-W
Phase 6	I6-F	Phase 6	J4-W
Phase 7	I7-F	Phase 7	J5-W
Phase 8	I8-F	Phase 8	J8-W

Provide the PCB 28/56 connector for the conflict monitor unit (CMU) with 28 independent contacts per side, dual-sided with 0.156 inch contact centers. Provide the PCB 28/56 connector contacts with solder eyelet terminations. Ensure all connections to the PCB 28/56 connector are soldered to the solder eyelet terminations.

Ensure that all cabinets have the CMU connector wired according to the 332 cabinet connector pin assignments (include all wires for auxiliary output file connection). Wire pins 13, 16, R, and U of the CMU connector to a separate 4 pin plug, P1, as shown below. Provide a second plug, P2, which will mate with P1 and is wired to the auxiliary output file as shown below. Provide an additional plug, P3, which will mate with P1 and is wired to the pedestrian yellow circuits as shown below. When no auxiliary output file is installed in the cabinet, provide wires for the green and yellow inputs for channels 11, 12, 17, and 18, the red inputs for channels 17 and 18, and the wires for the P2 plug. Terminate the two-foot wires with ring type lugs, insulated, and bundled for optional use.

PIN	P1		P2		P3	
	FUNCTION	CONN TO	FUNCTION	CONN TO	FUNCTION	CONN TO
1	CH-9G	CMU-13	OLA-GRN	A123	2P-YEL	114
2	CH-9Y	CMU-16	OLA-YEL	A122	4P-YEL	105
3	CH-10G	CMU-R	OLB-GRN	A126	6P-YEL	120
4	CH-10Y	CMU-U	OLB-YEL	A125	8P-YEL	111

Do not provide the P20 terminal assembly (red monitor board) or red interface ribbon cable as specified in LA Specification No. 54-053-08.

Provide a P20 connector that mates with and is compatible with the red interface connector mounted on the front of the conflict monitor. Ensure that the P20 connector and the red interface



connector on the conflict monitor are center polarized to ensure proper connection. Ensure that removal of the P20 connector will cause the conflict monitor to recognize a latching fault condition and place the cabinet into flashing operation.

Wire the P20 connector to the output file and auxiliary output file using 22 AWG stranded wires. Ensure the length of these wires is a minimum of 42 inches in length. Provide a durable braided sleeve around the wires to organize and protect the wires.

Wire the P20 connector to the traffic signal red displays to provide inputs to the conflict monitor as shown below. Ensure the pedestrian Don't Walk circuits are wired to channels 13 through 16 of the P20 connector. When no auxiliary output file is installed in the cabinet, provide wires for channels 9 through 12 reds. Provide a wire for special function 1. Terminate the unused wires with ring type lugs, insulated, and bundled for optional use.

P20 Connector					
PIN	FUNCTION	CONN TO	PIN	FUNCTION	CONN TO
1	Channel 15 Red	119	2	Channel 16 Red	110
3	Channel 14 Red	104	4	Chassis GND	01-9
5	Channel 13 Red	113	6	N/C	
7	Channel 12 Red	AUX 101	8	Spec Function 1	
9	Channel 10 Red	AUX 124	10	Channel 11 Red	AUX 114
11	Channel 9 Red	AUX 121	12	Channel 8 Red	107
13	Channel 7 Red	122	14	Channel 6 Red	134
15	Channel 5 Red	131	16	Channel 4 Red	101
17	Channel 3 Red	116	18	Channel 2 Red	128
19	Channel 1 Red	125	20	Red Enable	01-14

Ensure the controller unit outputs to the auxiliary output file are pre-wired to the C5 connector. When no auxiliary output file is installed in the cabinet, connect the C5 connector to a storage socket located on the Input Panel or on the rear of the PDA.

Do not wire pin 12 of the load switch sockets.

In addition to the requirements of LA Specification No. 54-053-08, ensure relay K1 on the Power Distribution Assembly (PDA) is a four pole relay and K2 on the PDA is a two pole relay.

Provide a two pole, ganged circuit breaker for the flash bus circuit. Ensure the flash bus circuit breaker is an inverse time circuit breaker rated for 10 amps at 120 VAC with a minimum of 10,000 RMS symmetrical amperes short circuit current rating. Do not provide the auxiliary switch feature on the flash bus circuit breaker. Ensure the ganged flash bus circuit breaker is certified by the circuit breaker manufacturer to provide gang tripping operation.

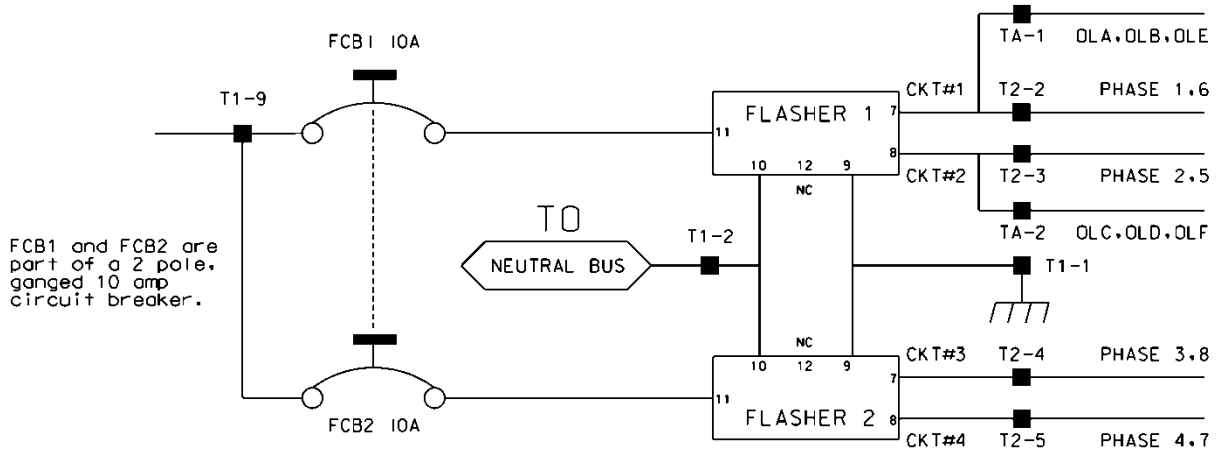

Ensure auxiliary output files are wired as follows:

AUXILIARY OUTPUT FILE	
TERMINAL BLOCK TA ASSIGNMENTS	
POSITION	FUNCTION
1	Flasher Unit #1, Circuit 1/FTR1 (OLA, OLB)/FTR3 (OLE)
2	Flasher Unit #1, Circuit 2/FTR2 (OLC, OLD)/FTR3 (OLF)
3	Flash Transfer Relay Coils
4	AC -
5	Power Circuit 5
6	Power Circuit 5
7	Equipment Ground Bus
8	NC

Provide four spare load resistors mounted in each cabinet. Ensure each load resistor is rated as shown in the table below. Wire one side of each load resistor to AC-. Connect the other side of each resistor to a separate terminal on a four (4) position terminal block. Mount the load resistors and terminal block either inside the back of Output File No. 1 or on the upper area of the Service Panel.

ACCEPTABLE LOAD RESISTOR VALUES	
VALUE (ohms)	WATTAGE
1.5K – 1.9 K	25W (min)
2.0K – 3.0K	10W (min)

Provide Model 200 load switches, Model 204 flashers, Model 242 DC isolators, Model 252 AC isolators, and Model 206L power supply units that conform to CALTRANS' *“Transportation Electrical Equipment Specifications”* dated March 12, 2009 with Erratum 1.

### C. Type 170 E Cabinet Physical Requirements:

Do not mold, cast, or scribe the name “City of Los Angeles” on the outside of the cabinet door as specified in LA Specification No. 54-053-08. Do not provide a Communications Terminal Panel as specified in LA Specification No. 54-053-08. Do not provide terminal block TBB on the Service Panel. Do not provide Cabinet Verification Test Program software or associated test jigs as specified in LA Specification No. 54-053-08.

Furnish unpainted, natural, aluminum cabinet shells. Ensure that all non-aluminum hardware on the cabinet is stainless steel or a Department approved non-corrosive alternate.

Ensure the lifting eyes, gasket channels, police panel, and all supports welded to the enclosure and doors are fabricated from 0.125 inch minimum thickness aluminum sheet and meet the same standards as the cabinet and doors.

Provide front and rear doors with latching handles that allow padlocking in the closed position. Furnish 0.75 inch minimum diameter stainless steel handles with a minimum 0.5 inch shank. Place the padlocking attachment at 4.0 inches from the handle shank center to clear the lock and key. Provide an additional 4.0 inches minimum gripping length.

Provide Corbin #2 locks on the front and rear doors. Provide one (1) Corbin #2 and one (1) police master key with each cabinet. Ensure main door locks allow removal of keys in the locked position only.

Provide a surge protection panel with 16 loop surge protection devices and designed to allow sufficient free space for wire connection/disconnection and surge protection device replacement. For model 332 cabinets, provide an additional 20 loop surge protection devices. Provide an additional two AC+ interconnect surge devices to protect one slot and eight DC surge protection devices to protect four slots. Provide no protection devices on slot I14.

For pole mounted cabinets, mount surge protection devices for the AC+ interconnect inputs, inductive loop detector inputs, and low voltage DC inputs on a swing down panel assembly fabricated from sturdy aluminum. Attach the swing down panel to the bottom rear cabinet rack assembly using thumb screws. Ensure the swing down panel allows for easy removal of the input file without removing the surge protection panel assembly or its parts. Have the surge protection devices mounted horizontally on the panel and soldered to the feed through terminals of four 14 position terminal blocks with #8 screws mounted on the other side. Ensure the top row of terminals is connected to the upper slots and the bottom row of terminals is connected to the bottom slots. Provide a 15 position copper equipment ground bus attached to the field terminal side (outside) of

the swing down panel for termination of loop lead-in shield grounds. Ensure that a Number 4 AWG green wire connects the surge protection panel assembly ground bus to the main cabinet equipment ground.

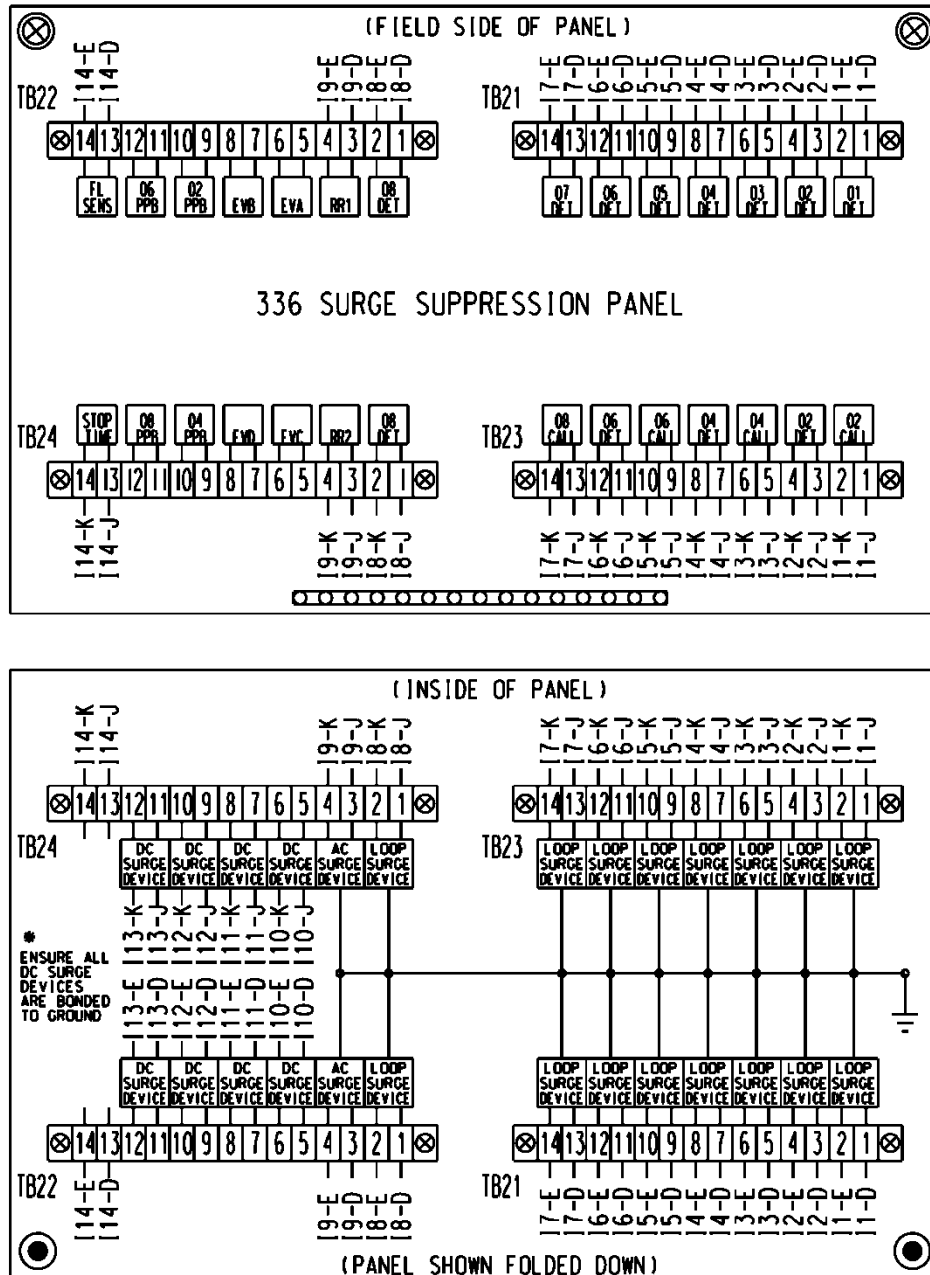

For base mounted cabinets, mount surge protection panels on the left side of the cabinet as viewed from the rear. Attach each panel to the cabinet rack assembly using bolts and make it easily removable. Mount the surge protection devices in vertical rows on each panel and connect the

devices to one side of 12 position, double row terminal blocks with #8 screws. For each surge protection panel, terminate all grounds from the surge protection devices on a copper equipment ground bus attached to the surge protection panel. Wire the terminals to the rear of a standard input file using spade lugs for input file protection.

Provide permanent labels that indicate the slot and the pins connected to each terminal that may be viewed from the rear cabinet door. Label and orient terminals so that each pair of inputs is next to each other. Indicate on the labeling the input file (I or J), the slot number (1-14) and the terminal pins of the input slots (either D & E for upper or J & K for lower).

Provide a minimum 14 x 16 inch pull out, hinged top shelf located immediately below controller mounting section of the cabinet. Ensure the shelf is designed to fully expose the table surface outside the controller at a height approximately even with the bottom of the controller. Ensure the shelf has a storage bin interior which is a minimum of 1 inch deep and approximately the same dimensions as the shelf. Provide an access to the storage area by lifting the hinged top of the shelf. Fabricate the shelf and slide from aluminum or stainless steel and ensure the assembly can support the 2070L controller plus 15 pounds of additional weight. Ensure shelf has a locking mechanism to secure it in the fully extended position and does not inhibit the removal of the 2070L controller or removal of cards inside the controller when fully extended. Provide a locking mechanism that is easily released when the shelf is to be returned to its non-use position directly under the controller.

#### **D. Model 2018 Enhanced Conflict Monitor:**

Furnish Model 2018 Enhanced Conflict Monitors that provide monitoring of 18 channels. Ensure each channel consists of a green, yellow, and red field signal input. Ensure that the conflict monitor meets or exceeds CALTRANS' Transportation Electrical Equipment Specifications dated March 12, 2009, with Erratum 1 (hereafter referred to as CALTRANS' 2009 TEES) for a model 210 monitor unit and other requirements stated in this specification.

Ensure the conflict monitor is provided with an 18 channel conflict programming card. Pin EE and Pin T of the conflict programming card shall be connected together. Pin 16 of the conflict programming card shall be floating. Ensure that the absence of the conflict programming card will cause the conflict monitor to trigger (enter into fault mode), and remain in the triggered state until the programming card is properly inserted and the conflict monitor is reset.

Provide a conflict monitor that incorporates LED indicators into the front panel to dynamically display the status of the monitor under normal conditions and to provide a comprehensive review of field inputs with monitor status under fault conditions. Ensure that the monitor indicates the channels that were active during a conflict condition and the channels that experienced a failure for all other per channel fault conditions detected. Ensure that these indications and the status of each channel are retained until the Conflict Monitor is reset. Furnish LED indicators for the following:

- AC Power (Green LED indicator)
- VDC Failed (Red LED indicator)
- WDT Error (Red LED indicator)
- Conflict (Red LED indicator)
- Red Fail (Red LED indicator)
- Dual Indication (Red LED indicator)

- Yellow/Clearance Failure (Red LED indicator)
- PCA/PC Ajar (Red LED indicator)
- Monitor Fail/Diagnostic Failure (Red LED indicator)
- 54 Channel Status Indicators (1 Red, 1 Yellow, and 1 Green LED indicator for each of the 18 channels)

Provide a switch to set the Red Fail fault timing. Ensure that when the switch is in the ON position the Red Fail fault timing value is set to 1350 +/- 150ms (2018 mode). Ensure that when the switch is in the OFF position the Red Fail fault timing value is set to 850 +/- 150ms (210 mode).

Provide a switch to set the Watchdog fault timing. Ensure that when the switch is in the ON position the Watchdog fault timing value is set to 1.0 +/- 0.1s (2018 mode). Ensure that when the switch is in the OFF position the Watchdog fault timing value is set to 1.5 +/- 0.1s (210 mode).

Provide a jumper or switch to set the AC line brown-out levels. Ensure that when the jumper is present or the switch is in the ON position the AC line dropout voltage threshold is 98 +/- 2 Vrms, the AC line restore voltage threshold is 103 +/- 2 Vrms, and the AC line brown-out timing value is set to 400 +/- 50ms (2018 mode). Ensure that when the jumper is not present or the switch is in the OFF position the AC line dropout voltage threshold is 92 +/- 2 Vrms, the AC line restore voltage threshold is 98 +/- 2 Vrms, and the AC line brown-out timing value is set to 80 +/- 17ms (210 mode).

Provide a jumper or switch that will enable and disable the Watchdog Latch function. Ensure that when the jumper is not present or the switch is in the OFF position the Watchdog Latch function is disabled. In this mode of operation, a Watchdog fault will be reset following a power loss, brownout, or power interruption. Ensure that when the jumper is present or the switch is in the ON position the Watchdog Latch function is enabled. In this mode of operation, a Watchdog fault will be retained until a Reset command is issued.

Provide a jumper that will reverse the active polarity for pin #EE (output relay common). Ensure that when the jumper is not present pin #EE (output relay common) will be considered 'Active' at a voltage greater than 70 Vrms and 'Not Active' at a voltage less than 50 Vrms (Caltrans mode). Ensure that when the jumper is present pin #EE (output relay common) will be considered 'Active' at a voltage less than 50 Vrms and 'Not Active' at a voltage greater than 70 Vrms (Failsafe mode).

In addition to the connectors required by CALTRANS' 2009 TEES, provide the conflict monitor with a red interface connector mounted on the front of the monitor. Ensure the connector is a 20 pin, right angle, center polarized, male connector with latching clip locks and polarizing keys. Ensure the right angle solder tails are designed for a 0.062" thick printed circuit board. Keying of the connector shall be between pins 3 and 5, and between 17 and 19. Ensure the connector has two rows of pins with the odd numbered pins on one row and the even pins on the other row. Ensure the connector pin row spacing is 0.10" and pitch is 0.10". Ensure the mating length of the connector pins is 0.24". Ensure the pins are finished with gold plating 30μ" thick.

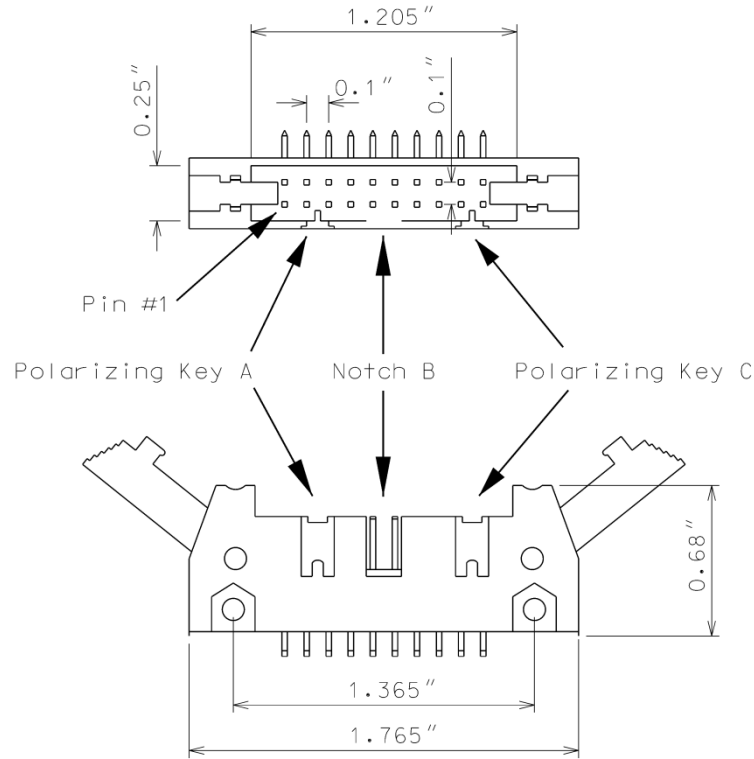

Ensure the red interface connector pins on the monitor have the following functions:

Pin #	Function	Pin #	Function
1	Channel 15 Red	2	Channel 16 Red
3	Channel 14 Red	4	Chassis Ground
5	Channel 13 Red	6	Special Function 2
7	Channel 12 Red	8	Special Function 1
9	Channel 10 Red	10	Channel 11 Red
11	Channel 9 Red	12	Channel 8 Red
13	Channel 7 Red	14	Channel 6 Red
15	Channel 5 Red	16	Channel 4 Red
17	Channel 3 Red	18	Channel 2 Red
19	Channel 1 Red	20	Red Enable

Ensure that removal of the P20 cable connector will cause the conflict monitor to recognize a latching fault condition and place the cabinet into flashing operation.

Provide Special Function 1 and Special Function 2 inputs to the unit which shall disable only Red Fail Monitoring when either input is sensed active. A Special Function input shall be sensed active when the input voltage exceeds 70 Vrms with a minimum duration of 550 ms. A Special Function input shall be sensed not active when the input voltage is less than 50 Vrms or the duration is less than 250 ms. A Special Function input is undefined by these specifications and may or may not be sensed active when the input voltage is between 50 Vrms and 70 Vrms or the duration is between 250 ms and 550 ms.

Ensure the conflict monitor recognizes field signal inputs for each channel that meet the following requirements:

- consider a Red input greater than 70 Vrms and with a duration of at least 500 ms as an “on” condition;
- consider a Red input less than 50 Vrms or with a duration of less than 200 ms as an “off” condition (no valid signal);
- consider a Red input between 50 Vrms and 70 Vrms or with a duration between 200 ms and 500 ms to be undefined by these specifications;
- consider a Green or Yellow input greater than 25 Vrms and with a duration of at least 500 ms as an “on” condition;
- consider a Green or Yellow input less than 15 Vrms or with a duration of less than 200 ms as an “off” condition; and
- consider a Green or Yellow input between 15 Vrms and 25 Vrms or with a duration between 200 ms and 500 ms to be undefined by these specifications.

Provide a conflict monitor that recognizes the faults specified by CALTRANS’ 2009 TEES and the following additional faults. Ensure the conflict monitor will trigger upon detection of a fault and will remain in the triggered (in fault mode) state until the unit is reset at the front panel or through the external remote reset input for the following failures:

1. **Red Monitoring or Absence of Any Indication (Red Failure):** A condition in which no “on” voltage signal is detected on any of the green, yellow, or red inputs to a given monitor channel. If a signal is not detected on at least one input (R, Y, or G) of a conflict monitor channel for a period greater than 1000 ms when used with a 170 controller and 1500 ms when used with a 2070L controller, ensure monitor will trigger and put the intersection into flash. If the absence of any indication condition lasts less than 750 ms when used with a 170 controller and 1200 ms when used with a 2070L controller, ensure conflict monitor will not trigger. Red fail monitoring shall be enabled on a per channel basis by the use of switches located on the conflict monitor. Have red monitoring occur when all of the following input conditions are in effect:
  - a) Red Enable input to monitor is active (Red Enable voltages are “on” at greater than 70 Vrms, off at less than 50 Vrms, undefined between 50 and 70 Vrms), and
  - b) Neither Special Function 1 nor Special Function 2 inputs are active.



- c) Pin #EE (output relay common) is not active
2. **Short/Missing Yellow Indication Fault (Clearance Error):** Yellow indication following a green is missing or shorter than 2.7 seconds (with  $\pm 0.1$ -second accuracy). If a channel fails to detect an “on” signal at the Yellow input for a minimum of 2.7 seconds ( $\pm 0.1$  second) following the detection of an “on” signal at a Green input for that channel, ensure that the monitor triggers and generates a clearance/short yellow error fault indication. Short/missing yellow (clearance) monitoring shall be enabled on a per channel basis by the use of switches located on the conflict monitor. This fault shall not occur when the channel is programmed for Yellow Inhibit, when the Red Enable signal is inactive or pin #EE (output relay common) is active.
  3. **Dual Indications on the Same Channel:** In this condition, more than one indication (R,Y,G) is detected as “on” at the same time on the same channel. If dual indications are detected for a period greater than 500 ms, ensure that the conflict monitor triggers and displays the proper failure indication (Dual Ind fault). If this condition is detected for less than 200 ms, ensure that the monitor does not trigger. G-Y-R dual indication monitoring shall be enabled on a per channel basis by the use of switches located on the conflict monitor. G-Y dual indication monitoring shall be enabled for all channels by use of a switch located on the conflict monitor. This fault shall not occur when the Red Enable signal is inactive or pin #EE (output relay common) is active.
  4. **Configuration Settings Change:** The configuration settings are comprised of (as a minimum) the permissive diode matrix, dual indication switches, yellow disable jumpers, any option switches, any option jumpers, and the Watchdog Enable switch. Ensure the conflict monitor compares the current configuration settings with the previous stored configuration settings on power-up, on reset, and periodically during operation. If any of the configuration settings are changed, ensure that the conflict monitor triggers and causes the program card indicator to flash. Ensure that configuration change faults are only reset by depressing and holding the front panel reset button for a minimum of three seconds. Ensure the external remote reset input does not reset configuration change faults.

Ensure the conflict monitor will trigger and the AC Power indicator will flash at a rate of 2 Hz  $\pm$  20% with a 50% duty cycle when the AC Line voltage falls below the “drop-out” level. Ensure the conflict monitor will resume normal operation when the AC Line voltage returns above the “restore” level. Ensure the AC Power indicator will remain illuminated when the AC voltage returns above the “restore” level. Should an AC Line power interruption occur while the monitor is in the fault mode, then upon restoration of AC Line power, the monitor will remain in the fault mode and the correct fault and channel indicators will be displayed.

Provide a flash interval of at least 6 seconds and at most 10 seconds in duration following a power-up, an AC Line interruption, or a brownout restore. Ensure the conflict monitor will suspend all fault monitoring functions, close the Output relay contacts, and flash the AC indicator at a rate of 4 Hz  $\pm$  20% with a 50% duty cycle during this interval. Ensure the termination of the flash interval after at least 6 seconds if the Watchdog input has made 5 transitions between the True and False state and the AC Line voltage is greater than the “restore” level. If the watchdog input has not made

5 transitions between the True and False state within  $10 \pm 0.5$  seconds, the monitor shall enter a WDT error fault condition.

Ensure the conflict monitor will monitor an intersection with a minimum of four approaches using the four-section Flashing Yellow Arrow (FYA) vehicle traffic signal as outlined by the NCHRP 3-54 research project for protected-permissive left turn signal displays. Ensure the conflict monitor will operate in the FYA mode and FYAc (Compact) mode as specified below to monitor each channel for the following fault conditions: Conflict, Red Fail, Dual Indication, and Clearance. Provide a switch to select between the FYA mode and FYAc mode. Provide a switch to select each FYA phase movement for monitoring.

**FYA mode**

FYA Signal Head	Phase 1	Phase 3	Phase 5	Phase 7
Red Arrow	Channel 9 Red	Channel 10 Red	Channel 11 Red	Channel 12 Red
Yellow Arrow	Channel 9 Yellow	Channel 10 Yellow	Channel 11 Yellow	Channel 12 Yellow
Flashing Yellow Arrow	Channel 9 Green	Channel 10 Green	Channel 11 Green	Channel 12 Green
Green Arrow	Channel 1 Green	Channel 3 Green	Channel 5 Green	Channel 7 Green

**FYAc mode**

FYA Signal Head	Phase 1	Phase 3	Phase 5	Phase 7
Red Arrow	Channel 1 Red	Channel 3 Red	Channel 5 Red	Channel 7 Red
Yellow Arrow	Channel 1 Yellow	Channel 3 Yellow	Channel 5 Yellow	Channel 7 Yellow
Flashing Yellow Arrow	Channel 1 Green	Channel 3 Green	Channel 5 Green	Channel 7 Green
Green Arrow	Channel 9 Green	Channel 9 Yellow	Channel 10 Green	Channel 10 Yellow

Ensure that the conflict monitor will log at least nine of the most recent events detected by the monitor in non-volatile EEPROM memory (or equivalent). For each event, record at a minimum the time, date, type of event, status of each field signal indication with RMS voltage, and specific channels involved with the event. Ensure the conflict monitor will log the following events: monitor reset, configuration, previous fault, and AC line. Furnish the signal sequence log that shows all channel states (Greens, Yellows, and Reds) and the Red Enable State for a minimum of 2 seconds prior to the current fault trigger point. Ensure the display resolution of the inputs for the signal sequence log is not greater than 50 ms.

For conflict monitors used within an Ethernet communications system, provide a conflict monitor with an Ethernet 10/100 Mbps, RJ-45 port for data communication access to the monitor by a local notebook computer and remotely via a workstation or notebook computer device connected to the signal system local area network. The Ethernet port shall be electrically isolated from the conflict monitor's electronics and shall provide a minimum of 1500 Vrms isolation. Integrate monitor with Ethernet network in cabinet. Provide software to retrieve the time and date from a network server in order to synchronize the on-board times between the conflict monitor and the controller. Furnish and install the following Windows based, graphic user interface software on workstations and notebook computers where the signal system client software is installed: 1) software to view and retrieve all event log information, 2) software that will search and display a list of conflict monitor IP addresses and IDs on the network, and 3) software to change the conflict monitor's network parameters such as IP address and subnet mask.

For non-Ethernet connected monitors, provide a RS-232C/D compliant port (DB-9 female connector) on the front panel of the conflict monitor in order to provide communications from the conflict monitor to the 170/2070L controller or to a Department-furnished laptop computer. Electrically isolate the port interface electronics from all monitor electronics, excluding Chassis Ground. Ensure that the controller can receive all event log information through a controller Asynchronous Communications Interface Adapter (Type 170E) or Async Serial Comm Module (2070). Furnish and connect a serial cable from the conflict monitor's DB-9 connector to Comm Port 1 of the 2070 controller. Ensure conflict monitor communicates with the controller. Provide a Windows based graphic user interface software to communicate directly through the same monitor RS-232C/D compliant port to retrieve and view all event log information to a Department-furnished laptop computer. The RS-232C/D compliant port on the monitor shall allow the monitor to function as a DCE device with pin connections as follows:

<b>Conflict Monitor RS-232C/D (DB-9 Female) Pinout</b>		
<b>Pin Number</b>	<b>Function</b>	<b>I/O</b>
1	DCD	O
2	TX Data	O
3	RX Data	I
4	DTR	I
5	Ground	-
6	DSR	O
7	CTS	I
8	RTS	O
9	NC	-

---

**MONITOR BOARD EDGE CONNECTOR**

---

<b>Pin #</b>	<b>Function (Back Side)</b>	<b>Pin #</b>	<b>Function (Component Side)</b>
1	Channel 2 Green	A	Channel 2 Yellow
2	Channel 13 Green	B	Channel 6 Green
3	Channel 6 Yellow	C	Channel 15 Green
4	Channel 4 Green	D	Channel 4 Yellow
5	Channel 14 Green	E	Channel 8 Green
6	Channel 8 Yellow	F	Channel 16 Green
7	Channel 5 Green	H	Channel 5 Yellow
8	Channel 13 Yellow	J	Channel 1 Green
9	Channel 1 Yellow	K	Channel 15 Yellow
10	Channel 7 Green	L	Channel 7 Yellow
11	Channel 14 Yellow	M	Channel 3 Green
12	Channel 3 Yellow	N	Channel 16 Yellow
13	Channel 9 Green	P	Channel 17 Yellow
14	Channel 17 Green	R	Channel 10 Green
15	Channel 11 Yellow	S	Channel 11 Green
16	Channel 9 Yellow	T	Channel 18 Yellow
17	Channel 18 Green	U	Channel 10 Yellow
--		--	
18	Channel 12 Yellow	V	Channel 12 Green
19	Channel 17 Red	W	Channel 18 Red
20	Chassis Ground	X	Not Assigned
21	AC-	Y	DC Common
22	Watchdog Timer	Z	External Test Reset
23	+24VDC	AA	+24VDC
24	Tied to Pin 25	BB	Stop Time (Output)
25	Tied to Pin 24	CC	Not Assigned
26	Not Assigned	DD	Not Assigned
27	Relay Output, Side #3, N.O.	EE	Relay Output, Side #2, Common
28	Relay Output, Side #1, N.C.	FF	AC+

-- Slotted for keying between Pins 17/U and 18/V

---

**CONFLICT PROGRAM CARD PIN ASSIGNMENTS**

---

<b>Pin #</b>	<b>Function (Back Side)</b>	<b>Pin #</b>	<b>Function (Component Side)</b>
1	Channel 2 Green	A	Channel 1 Green
2	Channel 3 Green	B	Channel 2 Green
3	Channel 4 Green	C	Channel 3 Green
4	Channel 5 Green	D	Channel 4 Green
5	Channel 6 Green	E	Channel 5 Green
6	Channel 7 Green	F	Channel 6 Green
7	Channel 8 Green	H	Channel 7 Green
8	Channel 9 Green	J	Channel 8 Green
9	Channel 10 Green	K	Channel 9 Green
10	Channel 11 Green	L	Channel 10 Green
11	Channel 12 Green	M	Channel 11 Green
12	Channel 13 Green	N	Channel 12 Green
13	Channel 14 Green	P	Channel 13 Green
14	Channel 15 Green	R	Channel 14 Green
15	Channel 16 Green	S	Channel 15 Green
16	N/C	T	PC AJAR
17	Channel 1 Yellow	U	Channel 9 Yellow
18	Channel 2 Yellow	V	Channel 10 Yellow
19	Channel 3 Yellow	W	Channel 11 Yellow
20	Channel 4 Yellow	X	Channel 12 Yellow
21	Channel 5 Yellow	Y	Channel 13 Yellow
22	Channel 6 Yellow	Z	Channel 14 Yellow
23	Channel 7 Yellow	AA	Channel 15 Yellow
24	Channel 8 Yellow	BB	Channel 16 Yellow
--		--	
25	Channel 17 Green	CC	Channel 17 Yellow
26	Channel 18 Green	DD	Channel 18 Yellow
27	Channel 16 Green	EE	PC AJAR (Program Card)
28	Yellow Inhibit Common	FF	Channel 17 Green

-- Slotted for keying between Pins 24/BB and 25/CC

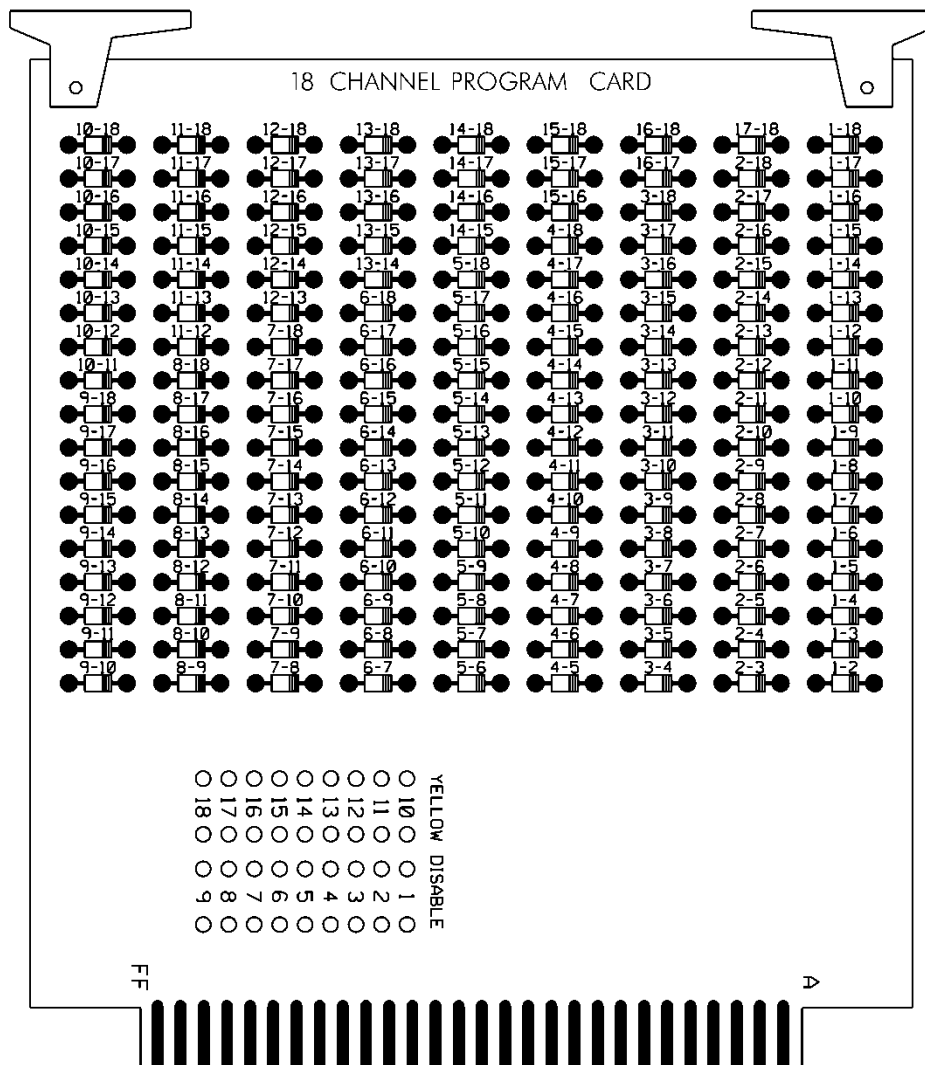

**E. Preemption and Sign Control Box**

Provide preemption and sign control box to operate in a Model 332 and Model 336S cabinet. Provide hardware to mount the box to the cage of the cabinet to ensure the front side is facing the opposite side of the cabinet. Furnish the material of the box from a durable finished metallic or thermoplastic case. Ensure the size of the box is not greater than 7(l) x 5(w) x 5(d) inches. Ensure that no modification is necessary to mount the box on the cabinet cage.

Provide the following components in the preemption and sign control box: relays, fuses, terminal blocks, MOVs, resistor, RC network, lamp, and push button switch.

Provide UL Listed or Recognized relay K1 as a DPDT enclosed relay (120 VAC, 60 Hz coil) with an 8-pin octal-style plug and associated octal base. Provide contact material made of AgCdO with a 10 amp, 240 VAC rating. Ensure the relay has a specified pickup voltage of 102 VAC.

Provide relay SSR1 as a Triac SPST normally open solid state relay that is rated for 120 VAC input and zero-crossing (resistive load) 25 amp @ 120 VAC output. Ensure the relay turns on at 90 Vrms within 10 ms and turns off at 10 Vrms within 40 ms. Ensure the relay has physical

characteristics as shown in the wiring detail in Figure 1. Provide 4 terminal screws with saddle clamps.

Provide fuses F1 and F2 as a UL Listed ¼" x 1-1/4" glass tube rated at 250 volts with a 10kA interrupting rating. Ensure F1 non-delay (fast-acting) and F2 slow-blow (time-delay) fuses have a maximum opening times of 60 minutes and 120 seconds for currents of 135 and 200 percent of the ampere rating, respectively. Ensure F2 slow-blow (time-delay) fuses have a minimum opening times of 12 seconds at 200 percent of the ampere rating. Provide fuse holders that are UL Recognized panel-mounted holders rated 250V, 15 ampere minimum with bayonet-type knobs which accept ¼" x 1-1/4" glass tube fuses.

Provide terminal blocks that are rated for 300V and are made of electrical grade thermoplastic or thermosetting plastic. Ensure each terminal block is of closed back design and has recessed-screw terminals with molded barriers between terminals. Ensure each terminal block is labeled with a block designation. Ensure each terminal is labeled with the function and a number.

Provide 3/4-inch diameter radial lead UL-recognized metal oxide varistors (MOVs) that have electrical performance as outlined below.

PROPERTIES OF MOV SURGE PROTECTOR	
Maximum Continuous Applied Voltage at 185° F	150 VAC (RMS) 200 VDC
Maximum Peak 8x20µs Current at 185° F	6500 A
Maximum Energy Rating at 185° F	80 J
Voltage Range 1 mA DC Test at 77° F	212-268 V
Max. Clamping Voltage 8x20µs, 100A at 77° F	395 V
Typical Capacitance (1 MHz) at 77° F	1600 pF

Provide resistor R1 as a 2K ohm, 12 watt, wirewound resistor with tinned terminals and attaching leads. Ensure the resistor is spaced apart from surrounding wires.

Provide a LED or incandescent lamp that has a voltage rating of 120 VAC with a minimum life rating at 50,000 hours.

Wire the preemption and sign control box as shown in Figure 1.



**RAILROAD PREEMPTION WIRING DETAIL**

(wire as shown below)

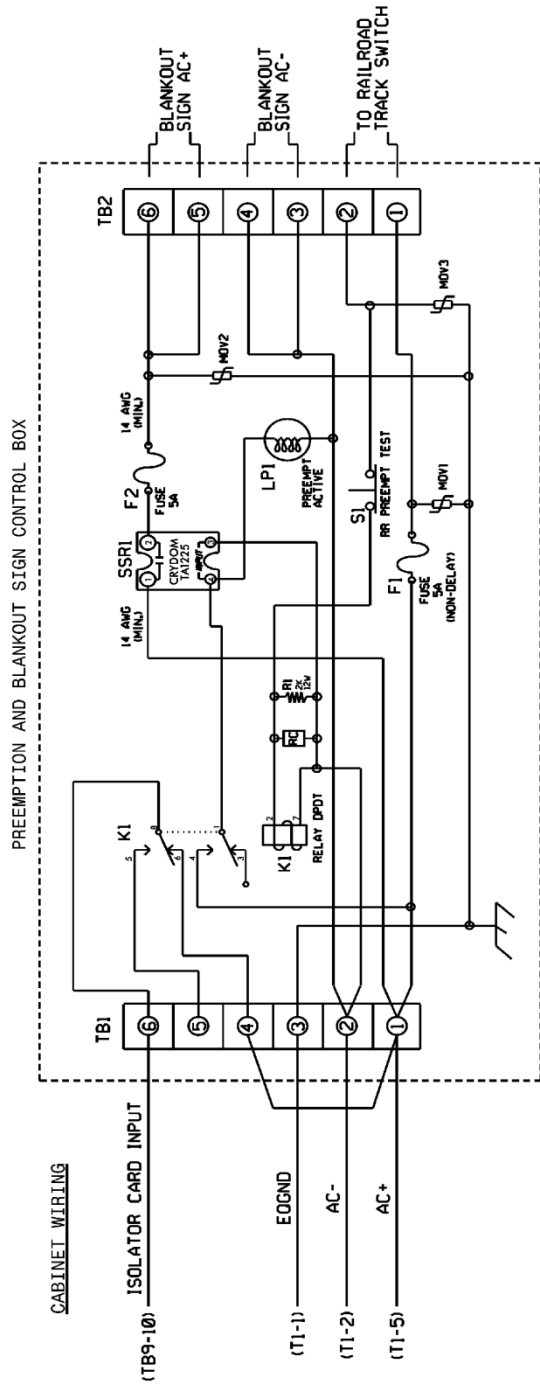

**NOTES**

1. RELAY K1 IS SHOWN IN THE ENERGIZED (PREEMPT NOI ACTIVE) NORMAL OPERATION STATE.
2. AC ISOLATOR CARD SHALL ACTIVATE PREEMPTION UPON REMOVAL OF AC+ FROM INPUT (AS SHOWN ABOVE). THIS IS ACCOMPLISHED BY SETTING TYPE 252 AC ISOLATOR CARD TO INVERTED OPERATION.

**FRONT VIEW**

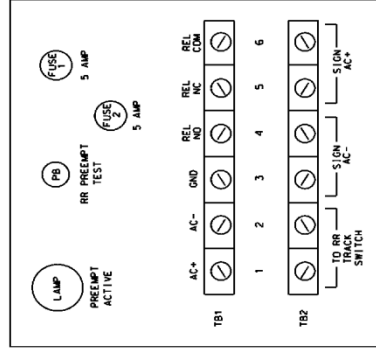

Figure 1

### 3.4. MATERIALS – TYPE 170 DETECTOR SENSOR UNITS

Furnish detector sensor units that comply with Chapter 5 Section 1, “General Requirements,” and Chapter 5 Section 2, “Model 222 & 224 Loop Detector Sensor Unit Requirements,” of the CALTRANS “Transportation Electrical Equipment Specifications” dated March 12, 2009 with Erratum 1.

### 3.5. MATERIALS – TYPE 2070E CONTROLLERS

Conform to CALTRANS *Transportation Electrical Equipment Specifications* (TEES) (dated March 12, 2009, plus Errata 1 dated January 21, 2010) except as required herein.

Furnish Model 2070E controllers. Ensure that removal of the CPU module from the controller will place the intersection into flash.

The Department will provide software at the beginning of the burning-in period. Contractor shall give 5 working days notice before needing software. Program software provided by the Department.

Provide Model 2070E controllers with the latest version of OS9 operating software and device drivers, composed of the unit chassis and at a minimum the following modules and assemblies:

- MODEL 2070-1E, CPU Module, Single Board, with 8Mb Datakey (blue in color)
- MODEL 2070-2A or approved MODEL 2070-2E, Field I/O Module (FI/O)
  - Note: Configure the Field I/O Module to disable both the External WDT Shunt/Toggle Switch and SP3 (SP3 active indicator is “off”)
- MODEL 2070-3B, Front Panel Module (FP), Display B (8x40)
- MODEL 2070-4, Power Supply Module, 10 AMP
- MODEL 2070-7A, Async Serial Com Module (9-pin RS-232)

Furnish one additional MODEL 2070-7A, Async Serial Com Module (9-pin RS-232) for all master controller locations.

For each master location and central control center, furnish a U.S. Robotics V.92 or approved equivalent auto-dial/auto-answer external modem to accomplish the interface to the Department-furnished microcomputers. Include all necessary hardware to ensure telecommunications.

## 4. GPS UNIT

### 4.1. DESCRIPTION

Furnish and install a GPS unit in the traffic signal cabinet for time synchronization in accordance with the plans and specifications. Comply with the provisions of Section 1700 of the 2012 Standard Specifications for Roads and Structures.

### 4.2. MATERIALS

Provide Trimble Acutime GG Smart Antenna, or an approved equivalent, for time synchronization that is compatible with Oasis 2070 controller software.

### 4.3. CONSTRUCTION METHODS

Mount GPS antenna on pole adjacent to cabinet at a minimum height of 10’ insuring that the antenna can acquire enough satellites to be accurate. Use ¾” rigid metallic conduit with appropriate fittings for mounting the antenna and running the lead-in cable. Provide GPS antenna lead-in cable that is not more than 50’ in length. Provide a drip loop in the cable before it enters the conduit. Insure the cable entry point into the conduit is waterproof. If a pole is not within 30’ of the cabinet,

the GPS antenna may be mounted to the top of the cabinet, while insuring that the connection point into the cabinet is waterproof.

**4.4. MEASUREMENT AND PAYMENT**

Actual number of GPS units furnished, installed, and accepted.

No measurement will be made for interface cables and connectors, as these are considered incidental to furnishing and installing the GPS unit assemblies.

Payment will be made under:

GPS Unit .....Each

**5. RELOCATE SCHOOL FLASHER**

**5.1. DESCRIPTION**

Relocate and maintain the existing school flasher and all necessary hardware to a new wood pole. Refer to the Traffic Management Plans and specifications. Comply with the provisions of Section 1700 of the 2012 Standard Specifications for Roads and Structures.

As an alternative to relocation, at no additional expense to the Department, the Contractor may furnish and install a new school flasher and all necessary hardware.

**5.2. MATERIALS**

Comply with the provisions of section 1098.

**5.3. CONSTRUCTION METHODS**

Perform work as required by the AASHTO *Standard Specifications for Structural Supports for Highway Signs, Luminaires, and Traffic Signals, 4<sup>th</sup> Edition, 2001*, and Section 1700 of the *Standard Specifications for for Road and Structures*.

**5.4. MEASUREMENT AND PAYMENT**

Actual number of school flashers relocated and accepted.

No measurement will be made for electric power, cable and connectors, as these will be considered incidental to relocation of the school flasher.

Payment will be made under:

Relocate School Flasher .....Each

# ST-1

Project B-5243

Union County

## Project Special Provisions Structure

### Table of Contents

	Page #
Optional Precast Reinforced Concrete Box Culvert at Station 19+67.20 -L-	(12-12-13).....ST-2
Falsework and Formwork	(4-5-12).....ST-9
Submittal of Working Drawings	(6-19-15).....ST-15
Crane Safety	(8-15-05).....ST-21
Grout for Structures	(9-30-11).....ST-22
Placement of Natural Stream Bed Material	(SPECIAL).....ST-24

10/21/2015



DocuSigned by:  
*Laura E. Sutton*  
AE35E3E6727640E...

# ST-2

## PROJECT SPECIAL PROVISIONS STRUCTURE

**PROJECT B-5243**

**UNION COUNTY**

### OPTIONAL PRECAST REINFORCED CONCRETE BOX CULVERT AT STATION 19+67.20 -L-

**(12-12-13)**

#### **1.0 GENERAL**

This Special Provision covers the design, fabrication and construction of precast reinforced concrete box culverts intended for the conveyance of storm water.

If the option is indicated on the plans, the submittal for a precast reinforced box culvert in lieu of a cast-in-place culvert is permitted. Design the precast culvert sections in accordance with ASTM C1577 or the current edition of the AASHTO LRFD Bridge Design Specifications. Rate all sizes of precast reinforced concrete box culverts in accordance with the current edition of the AASHTO Manual for Bridge Evaluation. Ensure the culvert rates for the AASHTO design loads and North Carolina's legal loads (see Section 2.0 for North Carolina's legal loads). Provide the size and number of barrels as indicated on the plans. Detail the culvert with cast-in-place wings walls and footings. Precast wing walls and footings will not be allowed. Provide a precast box culvert that meets the requirements of Section 1077 and any other applicable parts of the Standard Specifications.

The design and rating of the precast and cast-in-place members is the responsibility of the Contractor and is subject to review, comments and approval. Submit two sets of detailed plans and rating sheets for review. Include all details in the plans, including the size and spacing of the required reinforcement necessary to build the precast box and cast-in-place members. Have a North Carolina Registered Professional Engineer check and seal the plans, rating sheets and design calculations. After the plans, rating sheets and design calculations are reviewed and, if necessary, the corrections made, submit one set of plans and rating sheets on 22" x 34" sheets to become part of the contract plans.

If the span, rise and design earth cover for the precast reinforced concrete box culvert are identical to a previously approved submittal, the Contractor may request the previously approved design calculations and plans be considered as the submittal for review and approval. However, a set of plans and rating sheets will need to be submitted to become part of the contract plans.

# ST-3

B-5243

Union Co.

## 2.0 NORTH CAROLINA'S LEGAL LOADS

Apply the following legal loads to all structures carrying interstate traffic:

SINGLE VEHICLE(SV)		TRUCK TRACTOR SEMI-TRAILER(TTST)	
REF. #	SCHEMATIC	REF. #	SCHEMATIC
<b>SH</b>		<b>T4A</b>	
<b>S3A</b>		<b>T5B</b>	
<b>S3C</b>		<b>T6A</b>	
<b>S4A</b>		<b>T7A</b>	
<b>S5A</b>		<b>T7B</b>	
<b>S6A</b>			
<b>S7A</b>			
<b>S7B</b>			

# ST-4

B-5243

Union Co.

Apply the following legal loads to all structures carrying non-interstate traffic:

SINGLE VEHICLE (SV)			TRUCK TRACTOR SEMI-TRAILER (TTST)		
REF. #	SCHEMATIC		REF. #	SCHEMATIC	
<b>SNSH</b>	5K ○ ↓ 14' ○ 22K	27K 13.5 TON	<b>TNAGRIT3</b>	22K 22K 22K ○ ○ ○ ↓ ↓ ↓ 9' 9' 18' 66K 33 Ton	
<b>SNGARBS2</b>	23.5K ○ ↓ 14' ○ 16.5K	40K 20 TON	<b>TNT4A</b>	12.1K 12.05K 21K 21K ○ ○ ○ ○ ↓ ↓ ↓ ↓ 9' 9' 4' 22' 66.15K 33.075 TON	
<b>SNAGRIS2</b>	22K ○ ↓ 14' ○ 22K	44K 22 Ton	<b>TNAGRIT4</b>	22K 22K 21K 21K ○ ○ ○ ○ ↓ ↓ ↓ ↓ 9' 9' 4' 22' 86K 43 TON	
<b>SNCOTTS3</b>	4.5K 25K 25K ○ ○ ○ ↓ ↓ ↓ 11' 4' 15'	54.5K 27.25 TON	<b>TNAGT5A</b>	22K 21K 21K 13K 13K ○ ○ ○ ○ ○ ↓ ↓ ↓ ↓ ↓ 9' 4' 9' 4' 26' 90K 45 TON	
<b>SNAGGRS4</b>	16K 15.85K 19K 19K ○ ○ ○ ○ ↓ ↓ ↓ ↓ 9' 4' 4' 17'	69.85K 34.925 TON	<b>TNAGT5B</b>	6K 21K 21K 21K 21K ○ ○ ○ ○ ○ ↓ ↓ ↓ ↓ ↓ 9' 4' 9' 4' 26' 90K 45 TON	
<b>SNS5A</b>	12.1K 8.5K 21K 21K 8.5K ○ ○ ○ ○ ○ ↓ ↓ ↓ ↓ ↓ 9' 4' 4' 4' 21'	71.1K 35.55 TON	<b>TNT6A</b>	12.1K 8.2K 21K 21K 10.45K 10.45K ○ ○ ○ ○ ○ ○ ↓ ↓ ↓ ↓ ↓ ↓ 9' 4' 4' 9' 4' 30' 83.2K 41.6 TON	
<b>SNS6A</b>	12.1K 8.6K 8.6K 21K 21K 8.6K ○ ○ ○ ○ ○ ○ ↓ ↓ ↓ ↓ ↓ ↓ 9' 4' 4' 4' 4' 25'	79.9K 39.95 TON	<b>TNT7A</b>	4.1K 4K 21K 21K 11.3K 11.3K 11.3K ○ ○ ○ ○ ○ ○ ○ ↓ ↓ ↓ ↓ ↓ ↓ ↓ 9' 4' 4' 9' 4' 4' 34' 84K 42 TON	
<b>SNS7B</b>	7.6K 8.6K 8.6K 21K 21K 8.6K 8.6K ○ ○ ○ ○ ○ ○ ○ ↓ ↓ ↓ ↓ ↓ ↓ ↓ 9' 4' 4' 4' 4' 4' 29'	84K 42 TON	<b>TNT7B</b>	4.1K 10.5K 10.5K 8.45K 8.45K 21K 21K ○ ○ ○ ○ ○ ○ ○ ↓ ↓ ↓ ↓ ↓ ↓ ↓ 9' 4' 9' 4' 4' 4' 34' 84K 42 TON	

**3.0 PRECAST REINFORCED CONCRETE BOX SECTIONS**

The precast reinforced concrete box culvert sections shall match the size and hydraulic opening indicated in the contract plans.

**A. Design**

1. Design Fill – The design earth cover is reported on the plans as the elevation difference between the point of maximum fill and the bottom of the top slab.
2. Placement of Reinforcement – Provide a 1 inch concrete cover over the reinforcement subject to the provisions of Section F. Extend the inside reinforcement into the tongue portion of the joint and the outside reinforcement into the groove portion of the joint. Detail the clear distance of the end wires so it is not less than 1/2 inch or more than 2 inches from the ends of the box section. Assemble reinforcement per the requirements of ASTM C1577 or the approved design. The exposure of the ends of the wires used to position the reinforcement is not a cause for rejection.
3. Laps and Spacing – Use lap splices for the transverse reinforcement. Detail the transverse wires so that the center to center spacing is not less than 2 inches or more than 4 inches. Do not detail the longitudinal wires with a center to center spacing of more than 8 inches.

**B. Joints**

1. Produce the precast reinforced concrete box section with tongue and groove ends. Design and form these ends of the box section so, when the sections are laid together, they make a continuous line of box sections with a smooth interior free of appreciable irregularities in the flowline, all compatible with the permissible variations given in Section F. The internal joint formed at the tongue and groove ends of the precast units shall be sealed with either bitumen/butyl sealant or closed-cell neoprene material. The internal joint material shall be installed in accordance with the manufacturer's recommendations. The material shall be shown on the shop drawings when they are submitted for review.
2. Seal the external joint with an outside sealer wrap conforming to ASTM C877 that is at least 12 inches wide and covers the joint on both the sides and the top of the box section. Use ConWrap CS-212 from Concrete Sealants, Inc., EZ-Wrap from Press-Seal Gasket Corporation, Seal Wrap from Mar-Mac Manufacturing Co., Inc., Cadilloc External Pipe Joint from Cadilloc, or an approved equal for the outside sealer wrap. If the outside sealer wrap is not applied in a continuous strip along the entire joint, a 12 inch minimum lap of the outside sealer wrap is permitted. Before placing the outside sealer wrap, clean and prime the area receiving the outside sealer wrap in accordance with the sealer wrap manufacturer recommendations. The joint wrap manufacturer installation recommendations shall be included with shop drawings submitted for review. The external joint wrap shall be installed in pieces, as indicated on Figure 1 below:



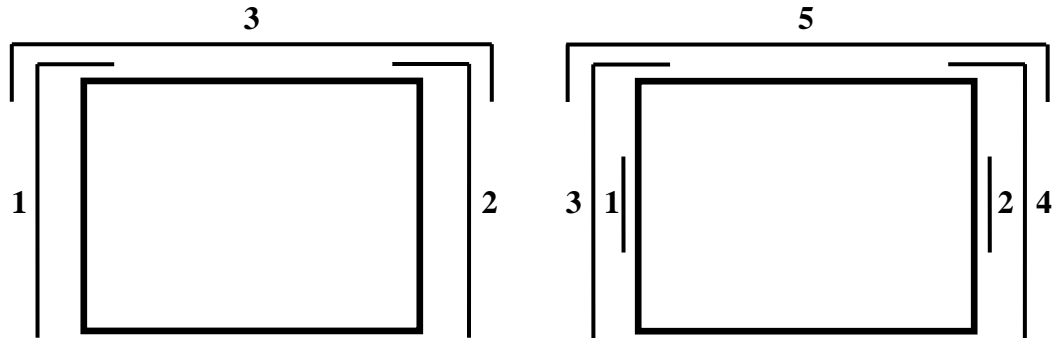

**Figure 1**

Cover the external joint sealer with a 3 foot strip of filter fabric conforming to Type 4 requirements in Section 1056 of the Standard Specifications.

Place multiple lines of a precast reinforced concrete box culvert such that the longitudinal joint between the sections has a minimum width of 3 inches. Fill the joint between multiple lines of precast box sections with Class A concrete. Use Class A concrete that meets the requirements listed in the Standard Specifications except that Field Compressive Strength Specimens are not required.

#### C. Manufacture

Manufacture precast reinforced concrete box culvert sections by either the wet cast method or dry cast method.

1. Mixture – In addition to the requirements of Section 1077 of the Standard Specifications, do not proportion the mix with less than 564 lb/yd<sup>3</sup> of portland cement.
2. Strength – Concrete shall develop a minimum 28-day compressive strength of 5000 psi. Movement of the precast sections should be minimized during the initial curing period. Any damage caused by moving or handling during the initial curing phase will be grounds for rejection of that precast section.
3. Air Entrainment – Air entrain the concrete in accordance with Section 1077-5(A) of the Standard Specifications. For dry cast manufacturing, air entrainment is not required.
4. Testing – Test the concrete in accordance with the requirements of Section 1077-5(B).
5. Handling – Handling devices or holes are permitted in each box section for the purpose of handling and placing. Submit details of handling devices or holes for approval and do not cast any concrete until approval is granted. Remove all handling devices flush with concrete surfaces as directed. Fill holes in a neat and

workmanlike manner with an approved non-metallic non-shrink grout, concrete, or hole plug.

**D. Physical Requirements**

Acceptability of precast culvert sections is based on concrete cylinders made and tested in accordance with ASTM C31 and ASTM C39.

**E. Permissible Variations**

1. Flatness – All external surfaces shall be flat, true, and plumb. Irregularities, depressions, or high spots on all external surfaces shall not exceed 1/2 inch in 8 feet.
2. Internal Dimensions – Produce sections so that the internal and haunch dimensions do not vary more than 1/4 inch from the plan dimensions.
3. Adjacent Sections - Internal, external, and haunch dimensions for connecting sections shall not vary more than 1/2 inch.
4. Length of Tongue and Groove – The minimum length of the tongue shall be 4 inches. The minimum length of the groove shall be 4 inches. The dimensions of the tongue and groove shall not vary more than 1/4 inch from the plan dimensions.
5. Slab and Wall Thickness – Produce sections so that the slab and wall thickness are not less than that shown on the plans by more than 5% or 3/16 inch, whichever is greater. A thickness more than that required on the plans is not a cause for rejection.
6. Length of Opposite Surfaces – Produce sections so that variations in laying lengths of two opposite surfaces of the box section meet the requirements of ASTM C1577, Section 11.3.
7. Length of Section – Produce sections so that the underrun in length of a section is not more than 1/2 inch in any box section.
8. Position of Reinforcement – Produce sections so that the maximum variation in the position of the reinforcement is  $\pm 3/8$  inch for slab and wall thicknesses of 5 inches or less and  $\pm 1/2$  inch for slab and wall thicknesses greater than 5 inches. Produce sections so that the concrete cover is never less than 5/8 inch as measured to the internal surface or the external surface. The preceding minimum cover limitations do not apply at the mating surfaces of the joint.
9. Area of Reinforcement – Use the design steel shown on the plans for the steel reinforcement. Steel areas greater than those required are not cause for rejection. The permissible variation in diameter of any wire in finished fabric is prescribed for the wire before fabrication by either AASHTO M32 or M225.

**F. Marking**

1. Each section shall be match-marked in order of intended installation as indicated on the approved shop drawings. Ensure that pieces fit together neatly and in a workmanlike manner. In order to ensure a good, neat field fit, the Department will verify assembly of the first five adjacent sections or 20% of the total culvert length, whichever is greater, at the producer's facility and match-mark the pieces. This will require that a minimum of three adjacent sections of the culvert be fitted at the production yard at a time and then match-marked. Once three sections have been match-marked, the first section may be removed for shipment and a fourth section set for marking. Continue in a progressive manner until all sections have been properly match-marked. The producer shall document the GO-NO-GO dimensional measurements of each box culvert section produced through the post-pour inspection process.
2. Clearly mark each section of the box culvert in accordance with ASTM C1577, Section 15. The information requirements of Section 15.1 shall be clearly marked on the inner surface of each section.

**G. Construction**

1. Pre-installation Meeting – A pre-installation meeting is required prior to installation. Representatives from the Contractor, the precast box manufacturer, and the Department should attend this meeting. The precast box manufacturer representative shall be on site during installation.
2. Foundation – Foundation for precast box culvert shall meet the requirements of Section 414 of the Standard Specifications. In addition, Type VI foundation material shall be encapsulated in filter fabric conforming to Type 4 requirements in Section 1056 of the Standard Specifications. The filter fabric shall be placed perpendicular to the culvert barrel. Provide sufficient overhang beyond the excavation to allow a minimum lap of 3 feet when the foundation material is placed and fabric wrapped on top. Perpendicular sections of fabric shall be continuous. A minimum lap of 2 feet shall be provided between sections of fabric.
3. Installation – Sections shall be placed at the beginning of the outlet end of the culvert with the groove end being laid upgrade. Tongue sections shall be laid into the groove sections. Positive means shall be provided to pull each section firmly into the previously placed section so that the joints are tightly homed. Use a "come-along", box pullers or other approved methods to create a positive means of joining box sections. Construction equipment shall not have direct contact with the box section. The load of the box shall be suspended by lifting device during joining procedure.
4. Backfill – Complete backfill in accordance with Section 414 of the Standard Specifications.

**4.0 BASIS OF PAYMENT**

Any additional cost of redesigning will be paid for by the Contractor if Precast Reinforced Concrete Culvert is used in lieu of the cast-in-place culvert shown on the plans. Except for Foundation Conditioning Material and Culvert Excavation, payment for the Precast Box Culvert will be a lump sum amount equal to the payment that would be allowed for construction of a Cast-in-Place Box Culvert. Plan quantities and unit bid prices will be used to compute the lump sum amount. Such price and payment will be full compensation for all work covered by this Special Provision, the plans and applicable parts of the Standard Specifications and will include, but not be limited to, furnishing all labor, materials (including all filter fabric), equipment and other incidentals necessary to complete this work. Such price and payment will also be full compensation for concrete, reinforcing steel, labor, equipment and all other related materials necessary for the completion of the barrel section, and the construction of the headwalls, leveling pad, end curtain walls, wings and wing footings.

**FALSEWORK AND FORMWORK****(4-5-12)****1.0 DESCRIPTION**

Use this Special Provision as a guide to develop temporary works submittals required by the Standard Specifications or other provisions; no additional submittals are required herein. Such temporary works include, but are not limited to, falsework and formwork.

Falsework is any temporary construction used to support the permanent structure until it becomes self-supporting. Formwork is the temporary structure or mold used to retain plastic or fluid concrete in its designated shape until it hardens. Access scaffolding is a temporary structure that functions as a work platform that supports construction personnel, materials, and tools, but is not intended to support the structure. Scaffolding systems that are used to temporarily support permanent structures (as opposed to functioning as work platforms) are considered to be falsework under the definitions given. Shoring is a component of falsework such as horizontal, vertical, or inclined support members. Where the term "temporary works" is used, it includes all of the temporary facilities used in bridge construction that do not become part of the permanent structure.

Design and construct safe and adequate temporary works that will support all loads imposed and provide the necessary rigidity to achieve the lines and grades shown on the plans in the final structure.

**2.0 MATERIALS**

Select materials suitable for temporary works; however, select materials that also ensure the safety and quality required by the design assumptions. The Engineer has authority to reject material on the basis of its condition, inappropriate use, safety, or nonconformance with the plans. Clearly identify allowable loads or stresses for all materials or manufactured devices on the plans. Revise the plan and notify the Engineer if any change to materials or material strengths is required.

**3.0 DESIGN REQUIREMENTS**

**A. Working Drawings**

Provide working drawings for items as specified in the contract, or as required by the Engineer, with design calculations and supporting data in sufficient detail to permit a structural and safety review of the proposed design of the temporary work.

On the drawings, show all information necessary to allow the design of any component to be checked independently as determined by the Engineer.

When concrete placement is involved, include data such as the drawings of proposed sequence, rate of placement, direction of placement, and location of all construction joints. Submit the number of copies as called for by the contract.

When required, have the drawings and calculations prepared under the guidance of, and sealed by, a North Carolina Registered Professional Engineer who is knowledgeable in temporary works design.

If requested by the Engineer, submit with the working drawings manufacturer’s catalog data listing the weight of all construction equipment that will be supported on the temporary work. Show anticipated total settlements and/or deflections of falsework and forms on the working drawings. Include falsework footing settlements, joint take-up, and deflection of beams or girders.

As an option for the Contractor, overhang falsework hangers may be uniformly spaced, at a maximum of 36 inches, provided the following conditions are met:

Member Type (PCG)	Member Depth, (inches)	Max. Overhang Width, (inches)	Max. Slab Edge Thickness, (inches)	Max. Screenshot Wheel Weight, (lbs.)	Bracket Min. Vertical Leg Extension, (inches)
II	36	39	14	2000	26
III	45	42	14	2000	35
IV	54	45	14	2000	44
MBT	63	51	12	2000	50
MBT	72	55	12	1700	48

Overhang width is measured from the centerline of the girder to the edge of the deck slab.

For Type II, III & IV prestressed concrete girders (PCG), 45-degree cast-in-place half hangers and rods must have a minimum safe working load of 6,000 lbs.

For MBT prestressed concrete girders, 45-degree angle holes for falsework hanger rods shall be cast through the girder top flange and located, measuring along the top of the

# ST-11

B-5243

Union Co.

member, 1'-2 ½" from the edge of the top flange. Hanger hardware and rods must have a minimum safe working load of 6,000 lbs.

The overhang bracket provided for the diagonal leg shall have a minimum safe working load of 3,750 lbs. The vertical leg of the bracket shall extend to the point that the heel bears on the girder bottom flange, no closer than 4 inches from the bottom of the member. However, for 72-inch members, the heel of the bracket shall bear on the web, near the bottom flange transition.

Provide adequate overhang falsework and determine the appropriate adjustments for deck geometry, equipment, casting procedures and casting conditions.

If the optional overhang falsework spacing is used, indicate this on the falsework submittal and advise the girder producer of the proposed details. Failure to notify the Engineer of hanger type and hanger spacing on prestressed concrete girder casting drawings may delay the approval of those drawings.

Falsework hangers that support concentrated loads and are installed at the edge of thin top flange concrete girders (such as bulb tee girders) shall be spaced so as not to exceed 75% of the manufacturer's stated safe working load. Use of dual leg hangers (such as Meadow Burke HF-42 and HF-43) are not allowed on concrete girders with thin top flanges. Design the falsework and forms supporting deck slabs and overhangs on girder bridges so that there will be no differential settlement between the girders and the deck forms during placement of deck concrete.

When staged construction of the bridge deck is required, detail falsework and forms for screed and fluid concrete loads to be independent of any previous deck pour components when the mid-span girder deflection due to deck weight is greater than ¾".

Note on the working drawings any anchorages, connectors, inserts, steel sleeves or other such devices used as part of the falsework or formwork that remains in the permanent structure. If the plan notes indicate that the structure contains the necessary corrosion protection required for a Corrosive Site, epoxy coat, galvanize or metalize these devices. Electroplating will not be allowed. Any coating required by the Engineer will be considered incidental to the various pay items requiring temporary works.

Design falsework and formwork requiring submittals in accordance with the 1995 AASHTO *Guide Design Specifications for Bridge Temporary Works* except as noted herein.

## 1. Wind Loads

Table 2.2 of Article 2.2.5.1 is modified to include wind velocities up to 110 mph. In addition, Table 2.2A is included to provide the maximum wind speeds by county in North Carolina.

**Table 2.2 - Wind Pressure Values**

Height Zone feet above ground	Pressure, lb/ft <sup>2</sup> for Indicated Wind Velocity, mph				
	70	80	90	100	110
0 to 30	15	20	25	30	35
30 to 50	20	25	30	35	40
50 to 100	25	30	35	40	45
over 100	30	35	40	45	50

2. Time of Removal

The following requirements replace those of Article 3.4.8.2.

Do not remove forms until the concrete has attained strengths required in Article 420-16 of the Standard Specifications and these Special Provisions.

Do not remove forms until the concrete has sufficient strength to prevent damage to the surface.

**Table 2.2A - Steady State Maximum Wind Speeds by Counties in North Carolina**

COUNTY	25 YR (mph)	COUNTY	25 YR (mph)	COUNTY	25 YR (mph)
Alamance	70	Franklin	70	Pamlico	100
Alexander	70	Gaston	70	Pasquotank	100
Alleghany	70	Gates	90	Pender	100
Anson	70	Graham	80	Perquimans	100
Ashe	70	Granville	70	Person	70
Avery	70	Greene	80	Pitt	90
Beaufort	100	Guilford	70	Polk	80
Bertie	90	Halifax	80	Randolph	70
Bladen	90	Harnett	70	Richmond	70
Brunswick	100	Haywood	80	Robeson	80
Buncombe	80	Henderson	80	Rockingham	70
Burke	70	Hertford	90	Rowan	70
Cabarrus	70	Hoke	70	Rutherford	70
Caldwell	70	Hyde	110	Sampson	90
Camden	100	Iredell	70	Scotland	70
Carteret	110	Jackson	80	Stanley	70
Caswell	70	Johnston	80	Stokes	70
Catawba	70	Jones	100	Surry	70

**Table 2.2A - Steady State Maximum Wind Speeds by Counties in North Carolina**

COUNTY	25 YR (mph)	COUNTY	25 YR (mph)	COUNTY	25 YR (mph)
Cherokee	80	Lee	70	Swain	80
Chatham	70	Lenoir	90	Transylvania	80
Chowan	90	Lincoln	70	Tyrell	100
Clay	80	Macon	80	Union	70
Cleveland	70	Madison	80	Vance	70
Columbus	90	Martin	90	Wake	70
Craven	100	McDowell	70	Warren	70
Cumberland	80	Mecklenburg	70	Washington	100
Currituck	100	Mitchell	70	Watauga	70
Dare	110	Montgomery	70	Wayne	80
Davidson	70	Moore	70	Wilkes	70
Davie	70	Nash	80	Wilson	80
Duplin	90	New Hanover	100	Yadkin	70
Durham	70	Northampton	80	Yancey	70
Edgecombe	80	Onslow	100		
Forsyth	70	Orange	70		

**B. Review and Approval**

The Engineer is responsible for the review and approval of temporary works' drawings.

Submit the working drawings sufficiently in advance of proposed use to allow for their review, revision (if needed), and approval without delay to the work.

The time period for review of the working drawings does not begin until complete drawings and design calculations, when required, are received by the Engineer.

Do not start construction of any temporary work for which working drawings are required until the drawings have been approved. Such approval does not relieve the Contractor of the responsibility for the accuracy and adequacy of the working drawings.

**4.0 CONSTRUCTION REQUIREMENTS**

All requirements of Section 420 of the Standard Specifications apply.

Construct temporary works in conformance with the approved working drawings. Ensure that the quality of materials and workmanship employed is consistent with that assumed in the design of the temporary works. Do not weld falsework members to any portion of the permanent structure unless approved. Show any welding to the permanent structure on the approved construction drawings.



Provide tell-tales attached to the forms and extending to the ground, or other means, for accurate measurement of falsework settlement. Make sure that the anticipated compressive settlement and/or deflection of falsework does not exceed 1 inch. For cast-in-place concrete structures, make sure that the calculated deflection of falsework flexural members does not exceed 1/240 of their span regardless of whether or not the deflection is compensated by camber strips.

## A. Maintenance and Inspection

Inspect and maintain the temporary work in an acceptable condition throughout the period of its use. Certify that the manufactured devices have been maintained in a condition to allow them to safely carry their rated loads. Clearly mark each piece so that its capacity can be readily determined at the job site.

Perform an in-depth inspection of an applicable portion(s) of the temporary works, in the presence of the Engineer, not more than 24 hours prior to the beginning of each concrete placement. Inspect other temporary works at least once a month to ensure that they are functioning properly. Have a North Carolina Registered Professional Engineer inspect the cofferdams, shoring, sheathing, support of excavation structures, and support systems for load tests prior to loading.

## B. Foundations

Determine the safe bearing capacity of the foundation material on which the supports for temporary works rest. If required by the Engineer, conduct load tests to verify proposed bearing capacity values that are marginal or in other high-risk situations.

The use of the foundation support values shown on the contract plans of the permanent structure is permitted if the foundations are on the same level and on the same soil as those of the permanent structure.

Allow for adequate site drainage or soil protection to prevent soil saturation and washout of the soil supporting the temporary works supports.

If piles are used, the estimation of capacities and later confirmation during construction using standard procedures based on the driving characteristics of the pile is permitted. If preferred, use load tests to confirm the estimated capacities; or, if required by the Engineer conduct load tests to verify bearing capacity values that are marginal or in other high risk situations.

The Engineer reviews and approves the proposed pile and soil bearing capacities.

## 5.0 REMOVAL

Unless otherwise permitted, remove and keep all temporary works upon completion of the work. Do not disturb or otherwise damage the finished work.

Remove temporary works in conformance with the contract documents. Remove them in such a manner as to permit the structure to uniformly and gradually take the stresses due to its own weight.

## 6.0 METHOD OF MEASUREMENT

Unless otherwise specified, temporary works will not be directly measured.

## 7.0 BASIS OF PAYMENT

Payment at the contract unit prices for the various pay items requiring temporary works will be full compensation for the above falsework and formwork.

## SUBMITTAL OF WORKING DRAWINGS

(6-19-15)

### 1.0 GENERAL

Submit working drawings in accordance with Article 105-2 of the *Standard Specifications* and this provision. For this provision, “submittals” refers to only those listed in this provision. The list of submittals contained herein does not represent a list of required submittals for the project. Submittals are only necessary for those items as required by the contract. Make submittals that are not specifically noted in this provision directly to the Engineer. Either the Structures Management Unit or the Geotechnical Engineering Unit or both units will jointly review submittals.

If a submittal contains variations from plan details or specifications or significantly affects project cost, field construction or operations, discuss the submittal with and submit all copies to the Engineer. State the reason for the proposed variation in the submittal. To minimize review time, make sure all submittals are complete when initially submitted. Provide a contact name and information with each submittal. Direct any questions regarding submittal requirements to the Engineer, Structures Management Unit contacts or the Geotechnical Engineering Unit contacts noted below.

In order to facilitate in-plant inspection by NCDOT and approval of working drawings, provide the name, address and telephone number of the facility where fabrication will actually be done if different than shown on the title block of the submitted working drawings. This includes, but is not limited to, precast concrete items, prestressed concrete items and fabricated steel or aluminum items.

### 2.0 ADDRESSES AND CONTACTS

For submittals to the Structures Management Unit, use the following addresses:

# ST-16

B-5243

Union Co.

Via US mail:

Mr. T. K. Koch, P. E.  
State Structures Engineer  
North Carolina Department of  
Transportation  
Structures Management Unit  
1581 Mail Service Center  
Raleigh, NC 27699-1581  
Attention: Mr. P. D. Lambert, P. E.

Via other delivery service:

Mr. T. K. Koch, P. E.  
State Structures Engineer  
North Carolina Department of  
Transportation  
Structures Management Unit  
1000 Birch Ridge Drive  
Raleigh, NC 27610  
Attention: Mr. P. D. Lambert, P. E.

Submittals may also be made via email. Send submittals to:

[plambert@ncdot.gov](mailto:plambert@ncdot.gov) (Paul Lambert)

Send an additional e-copy of the submittal to the following address:

[jgaither@ncdot.gov](mailto:jgaither@ncdot.gov) (James Gaither)

[mrorie@ncdot.gov](mailto:mrorie@ncdot.gov) (Madonna Rorie)

For submittals to the Geotechnical Engineering Unit, use the following addresses:

For projects in Divisions 1-7, use the following Eastern Regional Office address:

Via US mail:

Mr. K. J. Kim, Ph. D., P. E.  
Eastern Regional Geotechnical  
Manager  
North Carolina Department of  
Transportation  
Geotechnical Engineering Unit  
Eastern Regional Office  
1570 Mail Service Center  
Raleigh, NC 27699-1570

Via other delivery service:

Mr. K. J. Kim, Ph. D., P. E.  
Eastern Regional Geotechnical  
Manager  
North Carolina Department of  
Transportation  
Geotechnical Engineering Unit  
Eastern Regional Office  
3301 Jones Sausage Road, Suite 100  
Garner, NC 27529

For projects in Divisions 8-14, use the following Western Regional Office address:

Via US mail:

Mr. Eric Williams, P. E.  
Western Regional Geotechnical  
Manager  
North Carolina Department of  
Transportation  
Geotechnical Engineering Unit  
Western Regional Office  
5253 Z Max Boulevard  
Harrisburg, NC 28075

Via other delivery service:

Mr. Eric Williams, P. E.  
Western Regional Geotechnical  
Manager  
North Carolina Department of  
Transportation  
Geotechnical Engineering Unit  
Western Regional Office  
5253 Z Max Boulevard  
Harrisburg, NC 28075

The status of the review of structure-related submittals sent to the Structures Management Unit can be viewed from the Unit's web site, via the "Drawing Submittal Status" link.

# ST-17

B-5243

Union Co.

Direct any questions concerning submittal review status, review comments or drawing markups to the following contacts:

Primary Structures Contact:	Paul Lambert	(919) 707-6407 (919) 250-4082 facsimile <a href="mailto:plambert@ncdot.gov">plambert@ncdot.gov</a>
Secondary Structures Contacts:	James Gaither	(919) 707-6409 <a href="mailto:jgaither@ncdot.gov">jgaither@ncdot.gov</a>
	Madonna Rorie	(919) 707-6508 <a href="mailto:mrorie@ncdot.gov">mrorie@ncdot.gov</a>
Eastern Regional Geotechnical Contact (Divisions 1-7):	K. J. Kim	(919) 662-4710 (919) 662-3095 facsimile <a href="mailto:kkim@ncdot.gov">kkim@ncdot.gov</a>
Western Regional Geotechnical Contact (Divisions 8-14):	Eric Williams	(704) 455-8902 (704) 455-8912 facsimile <a href="mailto:ewilliams3@ncdot.gov">ewilliams3@ncdot.gov</a>

### 3.0 SUBMITTAL COPIES

Furnish one complete copy of each submittal, including all attachments, to the Engineer. At the same time, submit the number of hard copies shown below of the same complete submittal directly to the Structures Management Unit and/or the Geotechnical Engineering Unit.

The first table below covers “Structure Submittals”. The Engineer will receive review comments and drawing markups for these submittals from the Structures Management Unit. The second table in this section covers “Geotechnical Submittals”. The Engineer will receive review comments and drawing markups for these submittals from the Geotechnical Engineering Unit.

Unless otherwise required, submit one set of supporting calculations to either the Structures Management Unit or the Geotechnical Engineering Unit unless both units require submittal copies in which case submit a set of supporting calculations to each unit. Provide additional copies of any submittal as directed.

# ST-18

B-5243

Union Co.

## STRUCTURE SUBMITTALS

<b>Submittal</b>	<b>Copies Required by Structures Management Unit</b>	<b>Copies Required by Geotechnical Engineering Unit</b>	<b>Contract Reference Requiring Submittal <sup>1</sup></b>
Arch Culvert Falsework	5	0	Plan Note, SN Sheet & “Falsework and Formwork”
Box Culvert Falsework <sup>7</sup>	5	0	Plan Note, SN Sheet & “Falsework and Formwork”
Cofferdams	6	2	Article 410-4
Foam Joint Seals <sup>6</sup>	9	0	“Foam Joint Seals”
Expansion Joint Seals (hold down plate type with base angle)	9	0	“Expansion Joint Seals”
Expansion Joint Seals (modular)	2, then 9	0	“Modular Expansion Joint Seals”
Expansion Joint Seals (strip seals)	9	0	“Strip Seals”
Falsework & Forms <sup>2</sup> (substructure)	8	0	Article 420-3 & “Falsework and Formwork”
Falsework & Forms (superstructure)	8	0	Article 420-3 & “Falsework and Formwork”
Girder Erection over Railroad	5	0	Railroad Provisions
Maintenance and Protection of Traffic Beneath Proposed Structure	8	0	“Maintenance and Protection of Traffic Beneath Proposed Structure at Station ____”
Metal Bridge Railing	8	0	Plan Note
Metal Stay-in-Place Forms	8	0	Article 420-3
Metalwork for Elastomeric Bearings <sup>4,5</sup>	7	0	Article 1072-8
Miscellaneous Metalwork <sup>4,5</sup>	7	0	Article 1072-8
Disc Bearings <sup>4</sup>	8	0	“Disc Bearings”

# ST-19

B-5243

Union Co.

## STRUCTURE SUBMITTALS

<b>Submittal</b>	<b>Copies Required by Structures Management Unit</b>	<b>Copies Required by Geotechnical Engineering Unit</b>	<b>Contract Reference Requiring Submittal <sup>1</sup></b>
Overhead and Digital Message Signs (DMS) (metalwork and foundations)	13	0	Applicable Provisions
Placement of Equipment on Structures (cranes, etc.)	7	0	Article 420-20
Precast Concrete Box Culverts	2, then 1 reproducible	0	“Optional Precast Reinforced Concrete Box Culvert at Station ___”
Prestressed Concrete Cored Slab (detensioning sequences) <sup>3</sup>	6	0	Article 1078-11
Prestressed Concrete Deck Panels	6 and 1 reproducible	0	Article 420-3
Prestressed Concrete Girder (strand elongation and detensioning sequences)	6	0	Articles 1078-8 and 1078-11
Removal of Existing Structure over Railroad	5	0	Railroad Provisions
Revised Bridge Deck Plans (adaptation to prestressed deck panels)	2, then 1 reproducible	0	Article 420-3
Revised Bridge Deck Plans (adaptation to modular expansion joint seals)	2, then 1 reproducible	0	“Modular Expansion Joint Seals”
Sound Barrier Wall (precast items)	10	0	Article 1077-2 & “Sound Barrier Wall”
Sound Barrier Wall Steel Fabrication Plans <sup>5</sup>	7	0	Article 1072-8 & “Sound Barrier Wall”
Structural Steel <sup>4</sup>	2, then 7	0	Article 1072-8

**STRUCTURE SUBMITTALS**

<b>Submittal</b>	<b>Copies Required by Structures Management Unit</b>	<b>Copies Required by Geotechnical Engineering Unit</b>	<b>Contract Reference Requiring Submittal <sup>1</sup></b>
Temporary Detour Structures	10	2	Article 400-3 & "Construction, Maintenance and Removal of Temporary Structure at Station ____"
TFE Expansion Bearings <sup>4</sup>	8	0	Article 1072-8

**FOOTNOTES**

- References are provided to help locate the part of the contract where the submittals are required. References in quotes refer to the provision by that name. Articles refer to the *Standard Specifications*.
- Submittals for these items are necessary only when required by a note on plans.
- Submittals for these items may not be required. A list of pre-approved sequences is available from the producer or the Materials & Tests Unit.
- The fabricator may submit these items directly to the Structures Management Unit.
- The two sets of preliminary submittals required by Article 1072-8 of the *Standard Specifications* are not required for these items.
- Submittals for Fabrication Drawings are not required. Submittals for Catalogue Cuts of Proposed Material are required. See Section 5.A of the referenced provision.
- Submittals are necessary only when the top slab thickness is 18" or greater.

**GEOTECHNICAL SUBMITTALS**

<b>Submittal</b>	<b>Copies Required by Geotechnical Engineering Unit</b>	<b>Copies Required by Structures Management Unit</b>	<b>Contract Reference Requiring Submittal <sup>1</sup></b>
Drilled Pier Construction Plans <sup>2</sup>	1	0	Subarticle 411-3(A)
Crosshole Sonic Logging (CSL) Reports <sup>2</sup>	1	0	Subarticle 411-5(A)(2)
Pile Driving Equipment Data Forms <sup>2,3</sup>	1	0	Subarticle 450-3(D)(2)
Pile Driving Analyzer (PDA) Reports <sup>2</sup>	1	0	Subarticle 450-3(F)(3)
Retaining Walls <sup>4</sup>	8 drawings, 2 calculations	2 drawings	Applicable Provisions
Temporary Shoring <sup>4</sup>	5 drawings, 2 calculations	2 drawings	“Temporary Shoring” & “Temporary Soil Nail Walls”

**FOOTNOTES**

- References are provided to help locate the part of the contract where the submittals are required. References in quotes refer to the provision by that name. Subarticles refer to the *Standard Specifications*.
- Submit one hard copy of submittal to the Resident or Bridge Maintenance Engineer. Submit a second copy of submittal electronically (PDF via email) or by facsimile, US mail or other delivery service to the appropriate Geotechnical Engineering Unit regional office. Electronic submission is preferred.
- The Pile Driving Equipment Data Form is available from:  
[https://connect.ncdot.gov/resources/Geological/Pages/Geotech\\_Forms\\_Details.aspx](https://connect.ncdot.gov/resources/Geological/Pages/Geotech_Forms_Details.aspx)  
See second page of form for submittal instructions.
- Electronic copy of submittal is required. See referenced provision.

**CRANE SAFETY****(8-15-05)**

Comply with the manufacturer specifications and limitations applicable to the operation of any and all cranes and derricks. Prime contractors, sub-contractors, and fully operated rental companies shall comply with the current Occupational Safety and Health Administration regulations (OSHA).



Submit all items listed below to the Engineer prior to beginning crane operations involving critical lifts. A critical lift is defined as any lift that exceeds 75 percent of the manufacturer's crane chart capacity for the radius at which the load will be lifted or requires the use of more than one crane. Changes in personnel or equipment must be reported to the Engineer and all applicable items listed below must be updated and submitted prior to continuing with crane operations.

## CRANE SAFETY SUBMITTAL LIST

- A. **Competent Person:** Provide the name and qualifications of the "Competent Person" responsible for crane safety and lifting operations. The named competent person will have the responsibility and authority to stop any work activity due to safety concerns.
- B. **Riggers:** Provide the qualifications and experience of the persons responsible for rigging operations. Qualifications and experience should include, but not be limited to, weight calculations, center of gravity determinations, selection and inspection of sling and rigging equipment, and safe rigging practices.
- C. **Crane Inspections:** Inspection records for all cranes shall be current and readily accessible for review upon request.
- D. **Certifications:** **By July 1, 2006**, crane operators performing critical lifts shall be certified by NC CCO (National Commission for the Certification of Crane Operators), or satisfactorily complete the Carolinas AGC's Professional Crane Operator's Proficiency Program. Other approved nationally accredited programs will be considered upon request. All crane operators shall also have a current CDL medical card. Submit a list of anticipated critical lifts and corresponding crane operator(s). Include current certification for the type of crane operated (small hydraulic, large hydraulic, small lattice, large lattice) and medical evaluations for each operator.

## GROUT FOR STRUCTURES

(9-30-11)

### 1.0 DESCRIPTION

This special provision addresses grout for use in pile blockouts, grout pockets, shear keys, dowel holes and recesses for structures. This provision does not apply to grout placed in post-tensioning ducts for bridge beams, girders, or decks. Mix and place grout in accordance with the manufacturer's recommendations, the applicable sections of the Standard Specifications and this provision.

### 2.0 MATERIAL REQUIREMENTS

Use a Department approved pre-packaged, non-shrink, non-metallic grout. Contact the Materials and Tests Unit for a list of approved pre-packaged grouts and consult the manufacturer to determine if the pre-packaged grout selected is suitable for the required application.

When using an approved pre-packaged grout, a grout mix design submittal is not required.

The grout shall be free of soluble chlorides and contain less than one percent soluble sulfate. Supply water in compliance with Article 1024-4 of the Standard Specifications.

Aggregate may be added to the mix only where recommended or permitted by the manufacturer and Engineer. The quantity and gradation of the aggregate shall be in accordance with the manufacturer's recommendations.

Admixtures, if approved by the Department, shall be used in accordance with the manufacturer's recommendations. The manufacture date shall be clearly stamped on each container. Admixtures with an expired shelf life shall not be used.

The Engineer reserves the right to reject material based on unsatisfactory performance.

Initial setting time shall not be less than 10 minutes when tested in accordance with ASTM C266.

Test the expansion and shrinkage of the grout in accordance with ASTM C1090. The grout shall expand no more than 0.2% and shall exhibit no shrinkage. Furnish a Type 4 material certification showing results of tests conducted to determine the properties listed in the Standard Specifications and to assure the material is non-shrink.

Unless required elsewhere in the contract the compressive strength at 3 days shall be at least 5000 psi. Compressive strength in the laboratory shall be determined in accordance with ASTM C109 except the test mix shall contain only water and the dry manufactured material. Compressive strength in the field will be determined by molding and testing 4" x 8" cylinders in accordance with AASHTO T22. Construction loading and traffic loading shall not be allowed until the 3 day compressive strength is achieved.

When tested in accordance with ASTM C666, Procedure A, the durability factor of the grout shall not be less than 80.

### **3.0 SAMPLING AND PLACEMENT**

Place and maintain components in final position until grout placement is complete and accepted. Concrete surfaces to receive grout shall be free of defective concrete, laitance, oil, grease and other foreign matter. Saturate concrete surfaces with clean water and remove excess water prior to placing grout.

Do not place grout if the grout temperature is less than 50°F or more than 90°F or if the air temperature measured at the location of the grouting operation in the shade away from artificial heat is below 45°F.

Provide grout at a rate that permits proper handling, placing and finishing in accordance with the manufacturer's recommendations unless directed otherwise by the Engineer. Use grout free of any lumps and undispersed cement. Agitate grout continuously before placement.

# ST-24

B-5243

Union Co.

Control grout delivery so the interval between placing batches in the same component does not exceed 20 minutes.

The Engineer will determine the locations to sample grout and the number and type of samples collected for field and laboratory testing. The compressive strength of the grout will be considered the average compressive strength test results of 3 cube or 2 cylinder specimens at 28 days.

## 4.0 BASIS OF PAYMENT

No separate payment will be made for "Grout for Structures". The cost of the material, equipment, labor, placement, and any incidentals necessary to complete the work shall be considered incidental to the structure item requiring grout.

## PLACEMENT OF NATURAL STREAM BED MATERIAL

(SPECIAL)

### 1.0 GENERAL

The existing stream bed material shall be excavated from the stream bed or floodplain during culvert excavation. This material shall be stockpiled on the jobsite for use in backfilling both the low and high flow barrels as shown in the contract plans. Native material, with a gradation size similar to that of Class B Rip Rap, is subject to approval by the Engineer and may be subject to conditions in the permit.

If enough natural stream bed material is not available to backfill the high flow barrel, rip rap may be used to supplement the natural stream bed material. If rip rap is needed to supplement the stream bed material, it shall be placed in the bottom of the culvert barrels and topped with a minimum 6" layer of natural stream bed material.

The top surface of the natural stream bed material shall be placed and leveled to a flat surface to allow for animal passage.

### 2.0 PAYMENT

Payment for stream bed material will be at the contract lump sum price bid for "Placement of Natural Stream Bed Material". Prices and payment will be full compensation for placing all natural stream bed material, rip rap, labor, tools and equipment necessary to complete the item.

**PROJECT SPECIAL PROVISION**

(10-18-95) (Rev. 10-15-13)

Z-1

**PERMITS**

The Contractor's attention is directed to the following permits, which have been issued to the Department of Transportation by the authority granting the permit.

<b><u>PERMIT</u></b>	<b><u>AUTHORITY GRANTING THE PERMIT</u></b>
Dredge and Fill and/or Work in Navigable Waters (404)	U. S. Army Corps of Engineers
Water Quality (401)	Division of Environmental Management, DENR State of North Carolina
Buffer Certification	Division of Environmental Management, DENR State of North Carolina

The Contractor shall comply with all applicable permit conditions during construction of this project. Those conditions marked by \* are the responsibility of the Department and the Contractor has no responsibility in accomplishing those conditions.

Agents of the permitting authority will periodically inspect the project for adherence to the permits.

The Contractor's attention is also directed to Articles 107-10 and 107-13 of the *2012 Standard Specifications* and the following:

Should the Contractor propose to utilize construction methods (such as temporary structures or fill in waters and/or wetlands for haul roads, work platforms, cofferdams, etc.) not specifically identified in the permit (individual, general, or nationwide) authorizing the project it shall be the Contractor's responsibility to coordinate with the Engineer to determine what, if any, additional permit action is required. The Contractor shall also be responsible for initiating the request for the authorization of such construction method by the permitting agency. The request shall be submitted through the Engineer. The Contractor shall not utilize the construction method until it is approved by the permitting agency. The request normally takes approximately 60 days to process; however, no extensions of time or additional compensation will be granted for delays resulting from the Contractor's request for approval of construction methods not specifically identified in the permit.

**Where construction moratoriums are contained in a permit condition which restricts the Contractor's activities to certain times of the year, those moratoriums will apply only to the portions of the work taking place in the waters or wetlands provided that activities outside those areas is done in such a manner as to not affect the waters or wetlands.**

U.S. ARMY CORPS OF ENGINEERS  
WILMINGTON DISTRICT

Action Id. SAW-2015-01726 County: Union U.S.G.S. Quad: NC-MATTHEWS

**GENERAL PERMIT (REGIONAL AND NATIONWIDE) VERIFICATION**

Permittee:	<u>NCDOT</u>	
	<u>Richard Hancock</u>	
Address:	<u>1598 Mail Service Center</u>	
	<u>Raleigh, NC, 27699-1598</u>	
Telephone Number:	<u>919-707-6108</u>	
Size (acres)	<u>1.3</u>	Nearest Town <u>Indian Trail</u>
Nearest Waterway	<u>Crooked Creek</u>	River Basin <u>Rocky</u>
USGS HUC	<u>03040105</u>	Coordinates Latitude: <u>35.070889325076</u>
		Longitude: <u>-80.6754800273947</u>

Location description: The Indian Trail Road Bridge Replacement Project (TIP#B5243) begins just northeast of where Indian Trail Road crosses over South Fork Crooked Creek, and extends southwest to terminate at the intersection of Indian Trail Road with Coventry Drive in Indian Trail, Union County, North Carolina.

Description of projects area and activity: This permit authorizes the impacts associated with the replacement of an existing 30.15 foot single-span bridge with a double barrel 12' x 8' reinforced concrete box culvert on the existing alignment but with a wider road footprint. The widening of the roadway will additionally result in impacts associated with improvements of an adjacent intersection. Impacts authorized by this project are as follows:

Intersection improvement: the permanent impacts to 0.07 acres of wetland (0.02 acres resulting from mechanized clearing) and the permanent fill of 144 lf of stream channel, stabilization to 10 lf of stream channel and temporary impact to 47 lf of stream channel for the extension of culverts and bank stabilization.

Bridge replacement: permanent impact to 154 lf of stream channel and temporary impact to 10 lf of stream channel. The low flow 12' x 8' box culvert will be buried to 1' below stream bed and 1' sills will be installed at the inlet and outlet end. The floodplain culvert will have 4' sills at the inlet and outlet end.

In order to compensate for impacts associated with this permit, mitigation shall be provided in accordance with the provisions outlined on the most recent version of the attached Compensatory Mitigation Responsibility Transfer Form. The requirements of this form, including any special conditions listed on this form, are hereby incorporated as special conditions of this permit authorization.

Applicable Law:  Section 404 (Clean Water Act, 33 USC 1344)  
 Section 10 (Rivers and Harbors Act, 33 USC 403)

Authorization: Regional General Permit Number or Nationwide Permit Number: NWP 13 Bank Stabilization, NWP 23 Approved Categorical Exclusions, and NWP 33 Temporary Construction, Access and Dewatering

***SEE ATTACHED RGP or NWP GENERAL, REGIONAL AND SPECIAL CONDITIONS***

Your work is authorized by the above referenced permit provided it is accomplished in strict accordance with the attached conditions and your submitted application and attached information dated 08/27/2015 and 7/21/2015. Any violation of the attached conditions or deviation from your submitted plans may subject the permittee to a stop work order, a restoration order, a Class I administrative penalty, and/or appropriate legal action.

This verification will remain valid until the expiration date identified below unless the nationwide authorization is modified, suspended or revoked. If, prior to the expiration date identified below, the nationwide permit authorization is reissued and/or modified, this verification will remain valid until the expiration date identified below, provided it complies with all requirements of the modified nationwide permit. If the nationwide permit authorization expires or is suspended, revoked, or is modified, such that the activity would no longer comply with the terms and conditions of the nationwide permit, activities which have commenced (i.e., are under construction) or are under contract to commence in reliance upon the nationwide permit, will remain authorized provided the activity is completed within twelve months of the date of the nationwide permit's expiration, modification or revocation, unless discretionary authority has been exercised on a case-by-case basis to modify, suspend or revoke the authorization.

## P-3

Activities subject to Section 404 (as indicated above) may also require an individual Section 401 Water Quality Certification. You should contact the NC Division of Water Quality (telephone 919-807-6300) to determine Section 401 requirements.

For activities occurring within the twenty coastal counties subject to regulation under the Coastal Area Management Act (CAMA), prior to beginning work you must contact the N.C. Division of Coastal Management in Morehead City, NC, at (252) 808-2808.

This Department of the Army verification does not relieve the permittee of the responsibility to obtain any other required Federal, State or local approvals/permits.

If there are any questions regarding this verification, any of the conditions of the Permit, or the Corps of Engineers regulatory program, please contact Crystal Amschler at 828-271-7980 x231 or Crystal.C.Amschler@usace.army.mil.

Corps Regulatory Official: 

Date: 10/9/2015

Expiration Date of Verification: 03/18/2017



**Determination of Jurisdiction:**

- A.  Based on preliminary information, there appear to be waters of the US including wetlands within the above described project area. This preliminary determination is not an appealable action under the Regulatory Program Administrative Appeal Process (Reference 33 CFR Part 331).
- B.  There are Navigable Waters of the United States within the above described project area subject to the permit requirements of Section 10 of the Rivers and Harbors Act and Section 404 of the Clean Water Act. Unless there is a change in the law or our published regulations, this determination may be relied upon for a period not to exceed five years from the date of this notification.
- C.  There are waters of the US and/or wetlands within the above described project area subject to the permit requirements of Section 404 of the Clean Water Act (CWA)(33 USC § 1344). Unless there is a change in the law or our published regulations, this determination may be relied upon for a period not to exceed five years from the date of this notification.
- D.  The jurisdictional areas within the above described project area have been identified under a previous action. Please reference jurisdictional determination issued \_\_\_\_\_ Action ID: SAW- \_\_\_\_\_

**Basis For Determination:** Determination was based on review of aerial photography, USGS, soils and Lidar maps and observations made during the site visit. Wetlands met criteria set forth in the Corps 1987 delineation manual and the Eastern Mountains and Piedmont Region Supplement and tributaries were identified using OHWM as observed in the field. Wetlands are adjacent to tributaries on site which include South Fork Crooked Creek and a tributary of South Fork Crooked Creek. South Fork Crooked Creek flows into Crooked Creek, which flows into the Rocky River which flows into the Pee Dee River, a Section 10 Water.

**E. Attention USDA Program Participants**

This delineation/determination has been conducted to identify the limits of Corps' Clean Water Act jurisdiction for the particular site identified in this request. The delineation/determination may not be valid for the wetland conservation provisions of the Food Security Act of 1985. If you or your tenant are USDA Program participants, or anticipate participation in USDA programs, you should request a certified wetland determination from the local office of the Natural Resources Conservation Service, prior to starting work.

**F. Appeals Information (This information applies only to approved jurisdictional determinations as indicated in B and C above).**

This correspondence constitutes an approved jurisdictional determination for the above described site. If you object to this determination, you may request an administrative appeal under Corps regulations at 33 CFR Part 331. Enclosed you will find a Notification of Appeal Process (NAP) fact sheet and request for appeal (RFA) form. If you request to appeal this determination you must submit a completed RFA form to the following address:

US Army Corps of Engineers  
 South Atlantic Division  
 Attn: Jason Steele, Review Officer  
 60 Forsyth Street SW, Room 10M15  
 Atlanta, Georgia 30303-8801  
 Phone: (404) 562-5137

In order for an RFA to be accepted by the Corps, the Corps must determine that it is complete, that it meets the criteria for appeal under 33 CFR part 331.5, and that it has been received by the Division Office within 60 days of the date of the NAP. Should you decide to submit an RFA form, it must be received at the above address by \_\_\_\_\_

\*\*It is not necessary to submit an RFA form to the Division Office if you do not object to the determination in this correspondence.\*\*

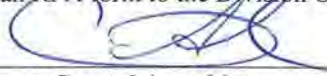
Corps Regulatory Official:  Date of JD: 10/9/2015  
**Crystal Amschler**

The Wilmington District is committed to providing the highest level of support to the public. To help us ensure we continue to do so, please complete our customer Satisfaction Survey online at <http://regulatory.usacesurvey.com/>.

Action ID Number: SAW-2015-01726

County: Union

Permittee: NCDOT, Mr. Richard Hancock

Project Name: Indian Train Road Bridge Replacement over South Fork Crooked Creek TIP B5243 DOT Division 10

Date Verification Issued: 10/9/2015

Project Manager: Crystal Amschler

Upon completion of the activity authorized by this permit and any mitigation required by the permit, sign this certification and return it to the following address:

**US ARMY CORPS OF ENGINEERS  
WILMINGTON DISTRICT  
Attn: Crystal Amschler, Project Manager  
Asheville Regulatory Field Office  
151 Patton Avenue, Room 208  
Asheville, North Carolina 28801**

Please note that your permitted activity is subject to a compliance inspection by a U. S. Army Corps of Engineers representative. Failure to comply with any terms or conditions of this authorization may result in the Corps suspending, modifying or revoking the authorization and/or issuing a Class I administrative penalty, or initiating other appropriate legal action.

I hereby certify that the work authorized by the above referenced permit has been completed in accordance with the terms and condition of the said permit, and required mitigation was completed in accordance with the permit conditions.

\_\_\_\_\_  
Signature of Permittee

\_\_\_\_\_  
Date



**NATIONWIDE PERMIT 13  
DEPARTMENT OF THE ARMY  
CORPS OF ENGINEERS  
FINAL NOTICE OF ISSUANCE AND MODIFICATION OF NATIONWIDE PERMITS  
FEDERAL REGISTER  
AUTHORIZED MARCH 19, 2012**

**Bank Stabilization.** Bank stabilization activities necessary for erosion prevention, provided the activity meets all of the following criteria:

- (a) No material is placed in excess of the minimum needed for erosion protection;
- (b) The activity is no more than 500 feet in length along the bank, unless the district engineer waives this criterion by making a written determination concluding that the discharge will result in minimal adverse effects;
- (c) The activity will not exceed an average of one cubic yard per running foot placed along the bank below the plane of the ordinary high water mark or the high tide line, unless the district engineer waives this criterion by making a written determination concluding that the discharge will result in minimal adverse effects;
- (d) The activity does not involve discharges of dredged or fill material into special aquatic sites, unless the district engineer waives this criterion by making a written determination concluding that the discharge will result in minimal adverse effects;
- (e) No material is of a type, or is placed in any location, or in any manner, that will impair surface water flow into or out of any waters of the United States;
- (f) No material is placed in a manner that will be eroded by normal or expected high flows (properly anchored trees and treetops may be used in low energy areas); and,
- (g) The activity is not a stream channelization activity.

This NWP also authorizes temporary structures, fills, and work necessary to construct the bank stabilization activity. Appropriate measures must be taken to maintain normal downstream flows and minimize flooding to the maximum extent practicable, when temporary structures, work, and discharges, including cofferdams, are necessary for construction activities, access fills, or dewatering of construction sites. Temporary fills must consist of materials, and be placed in a manner, that will not be eroded by expected high flows. Temporary fills must be removed in their entirety and the affected areas returned to pre-construction elevations. The areas affected by temporary fills must be revegetated, as appropriate.

Invasive plant species shall not be used for bioengineering or vegetative bank stabilization.

- \* **Notification:** The permittee must submit a pre-construction notification to the district engineer prior to commencing the activity if the bank stabilization activity: (1) involves discharges into special aquatic sites; or (2) is in excess of 500 feet in length; or (3) will involve the discharge of greater than an average of one cubic yard per running foot along the bank below the plane of the ordinary high water mark or the high tide line. (See general condition 31.) (Sections 10 and 404)

**NATIONWIDE PERMIT 23  
DEPARTMENT OF THE ARMY  
CORPS OF ENGINEERS  
FINAL NOTICE OF ISSUANCE AND MODIFICATION OF NATIONWIDE PERMITS  
FEDERAL REGISTER  
AUTHORIZED MARCH 19, 2012**

**Approved Categorical Exclusions.** Activities undertaken, assisted, authorized, regulated, funded, or financed, in whole or in part, by another Federal agency or department where:

(a) That agency or department has determined, pursuant to the Council on Environmental Quality's implementing regulations for the National Environmental Policy Act (40 CFR part 1500 et seq.), that the activity is categorically excluded from environmental documentation, because it is included within a category of actions which neither individually nor cumulatively have a significant effect on the human environment; and

(b) The Office of the Chief of Engineers (Attn: CECW-CO) has concurred with that agency's or department's determination that the activity is categorically excluded and approved the activity for authorization under NWP 23.

The Office of the Chief of Engineers may require additional conditions, including pre-construction notification, for authorization of an agency's categorical exclusions under this NWP.

\* **Notification:** Certain categorical exclusions approved for authorization under this NWP require the permittee to submit a pre-construction notification to the district engineer prior to commencing the activity (see general condition 31). The activities that require pre-construction notification are listed in the appropriate Regulatory Guidance Letters. (Sections 10 and 404)

**Note:** The agency or department may submit an application for an activity believed to be categorically excluded to the Office of the Chief of Engineers (Attn: CECW-CO). Prior to approval for authorization under this NWP of any agency's activity, the Office of the Chief of Engineers will solicit public comment. As of the date of issuance of this NWP, agencies with approved categorical exclusions are the: Bureau of Reclamation, Federal Highway Administration, and U.S. Coast Guard. Activities approved for authorization under this NWP as of the date of this notice are found in Corps Regulatory Guidance Letter 05-07, which is available at:

<http://www.usace.army.mil/Missions/CivilWorks/RegulatoryProgramandPermits/GuidanceLetters.aspx> . Any future approved categorical exclusions will be announced in Regulatory Guidance Letters and posted on this same web site.

**NATIONWIDE PERMIT 33  
DEPARTMENT OF THE ARMY  
CORPS OF ENGINEERS  
FINAL NOTICE OF ISSUANCE AND MODIFICATION OF NATIONWIDE PERMITS  
FEDERAL REGISTER  
AUTHORIZED MARCH 19, 2012**

**Temporary Construction, Access, and Dewatering.** Temporary structures, work, and discharges, including cofferdams, necessary for construction activities or access fills or dewatering of construction sites, provided that the associated primary activity is authorized by the Corps of Engineers or the U.S. Coast Guard. This NWP also authorizes temporary structures, work, and discharges, including cofferdams, necessary for construction activities not otherwise subject to the Corps or U.S. Coast Guard permit requirements. Appropriate measures must be taken to maintain near normal downstream flows and to minimize flooding. Fill must consist of materials, and be placed in a manner, that will not be eroded by expected high flows. The use of dredged material may be allowed if the district engineer determines that it will not cause more than minimal adverse effects on aquatic resources. Following completion of construction, temporary fill must be entirely removed to an area that has no waters of the United States, dredged material must be returned to its original location, and the affected areas must be restored to pre-construction elevations. The affected areas must also be revegetated, as appropriate. This permit does not authorize the use of cofferdams to dewater wetlands or other aquatic areas to change their use. Structures left in place after construction is completed require a separate section 10 permit if located in navigable waters of the United States. (See 33 CFR part 322.)

\* **Notification:** The permittee must submit a pre-construction notification to the district engineer prior to commencing the activity (see general condition 31). The pre-construction notification must include a restoration plan showing how all temporary fills and structures will be removed and the area restored to pre-project conditions. (Sections 10 and 404)

**NATIONWIDE PERMIT CONDITIONS**

The following General Conditions must be followed in order for any authorization by a NWP to be valid:

1. Navigation. (a) No activity may cause more than a minimal adverse effect on navigation.

(b) Any safety lights and signals prescribed by the U.S. Coast Guard, through regulations or otherwise, must be installed and maintained at the permittee's expense on authorized facilities in navigable waters of the United States.

(c) The permittee understands and agrees that, if future operations by the United States require the removal, relocation, or other alteration, of the structure or work herein authorized, or if, in the opinion of the Secretary of the Army or his authorized representative, said structure or work shall cause unreasonable obstruction to the free navigation of the navigable waters, the permittee will be required, upon due notice from the Corps of Engineers, to remove, relocate, or alter the structural work or obstructions caused thereby, without expense to the United States. No claim shall be made against the United States on account of any such removal or alteration.

2. Aquatic Life Movements. No activity may substantially disrupt the necessary life cycle movements of those species of aquatic life indigenous to the waterbody, including those species that normally migrate through the area, unless the activity's primary purpose is to impound water. All permanent and temporary crossings of waterbodies shall be suitably culverted, bridged, or otherwise designed and constructed to maintain low flows to sustain the movement of those aquatic species.

3. Spawning Areas. Activities in spawning areas during spawning seasons must be avoided to the maximum extent practicable. Activities that result in the physical destruction (e.g., through excavation, fill, or downstream smothering by substantial turbidity) of an important spawning area are not authorized.

4. Migratory Bird Breeding Areas. Activities in waters of the United States that serve as breeding areas for migratory birds must be avoided to the maximum extent practicable.

5. Shellfish Beds. No activity may occur in areas of concentrated shellfish populations, unless the activity is directly related to a shellfish harvesting activity authorized by NWPs 4 and 48, or is a shellfish seeding or habitat restoration activity authorized by NWP 27.

6. Suitable Material. No activity may use unsuitable material (e.g., trash, debris, car bodies, asphalt, etc.). Material used for construction or discharged must be free from toxic pollutants in toxic amounts (see Section 307 of the Clean Water Act).

7. Water Supply Intakes. No activity may occur in the proximity of a public water supply intake, except where the activity is for the repair or improvement of public water supply intake structures or adjacent bank stabilization.

8. Adverse Effects From Impoundments. If the activity creates an impoundment of water, adverse effects to the aquatic system due to accelerating the passage of water, and/or restricting its flow must be minimized to the maximum extent practicable.

9. Management of Water Flows. To the maximum extent practicable, the pre-construction course, condition, capacity, and location of open waters must be maintained for each activity, including stream channelization and storm water management activities, except as provided below. The activity must be constructed to withstand expected high flows. The activity must not restrict or impede the passage of normal or high flows, unless the primary purpose of the activity is to impound water or manage high flows. The activity may alter the pre-construction course, condition, capacity, and location of open waters if it benefits the aquatic environment (e.g., stream restoration or relocation activities).

10. Fills Within 100-Year Floodplains. The activity must comply with applicable FEMA-approved state or local floodplain management requirements.

11. Equipment. Heavy equipment working in wetlands or mudflats must be placed on mats, or other measures must be taken to minimize soil disturbance.

12. Soil Erosion and Sediment Controls. Appropriate soil erosion and sediment controls must be used and maintained in effective operating condition during construction, and all exposed soil and other fills, as well as any work below the ordinary high water mark or high tide line, must be permanently stabilized at the earliest practicable date. Permittees are encouraged to perform work within waters of the United States during periods of low-flow or no-flow.

13. Removal of Temporary Fills. Temporary fills must be removed in their entirety and the affected areas returned to pre-construction elevations. The affected areas must be revegetated, as appropriate.

14. Proper Maintenance. Any authorized structure or fill shall be properly maintained, including maintenance to ensure public safety and compliance with applicable NWP general conditions, as well as any activity-specific conditions added by the district engineer to an NWP authorization.

15. Single and Complete Project. The activity must be a single and complete project. The same NWP cannot be used more than once for the same single and complete project.

16. Wild and Scenic Rivers. No activity may occur in a component of the National Wild and Scenic River System, or in a river officially designated by Congress as a “study river” for possible inclusion in the system while the river is in an official study status, unless the appropriate Federal agency with direct management responsibility for such river, has determined in writing that the proposed activity will not adversely affect the Wild and Scenic River designation or study status. Information on Wild and Scenic Rivers may be obtained from the appropriate Federal land management agency responsible for the designated Wild and Scenic River or study river (e.g., National Park Service, U.S. Forest Service, Bureau of Land Management, U.S. Fish and Wildlife Service).

17. Tribal Rights. No activity or its operation may impair reserved tribal rights, including, but not limited to, reserved water rights and treaty fishing and hunting rights.

18. Endangered Species. (a) No activity is authorized under any NWP which is likely to directly or indirectly jeopardize the continued existence of a threatened or endangered species or a species proposed for such designation, as identified under the Federal Endangered Species Act (ESA), or which will directly or indirectly destroy or adversely modify the critical habitat of such species. No activity is authorized under any NWP which “may affect” a listed species or critical habitat, unless Section 7 consultation addressing the effects of the proposed activity has been completed.

(b) Federal agencies should follow their own procedures for complying with the requirements of the ESA. Federal permittees must provide the district engineer with the appropriate documentation to demonstrate compliance with those requirements. The district engineer will review the documentation and determine whether it is sufficient to address ESA compliance for the NWP activity, or whether additional ESA consultation is necessary.

\* (c) Non-federal permittees must submit a pre-construction notification to the district engineer if any listed species or designated critical habitat might be affected or is in the vicinity of the project, or if the project is located in designated critical habitat, and shall not begin work on the activity until notified by the district engineer that the requirements of the ESA have been satisfied and that the activity is authorized. For activities that might affect Federally-listed endangered or threatened species or designated critical habitat, the pre-construction notification must include the name(s) of the endangered or threatened species that might be affected by the proposed work or that utilize the designated critical habitat that might be affected by the proposed work. The district engineer will determine whether the proposed activity “may affect” or will have “no effect” to listed species and designated critical habitat and will notify the non-Federal applicant of the Corps’ determination within 45 days of receipt of a complete pre-construction notification. In cases where the non-Federal applicant has identified listed species or critical habitat that might be affected or is in the vicinity of the project, and has so notified the Corps, the applicant shall not begin work until the Corps has provided notification the proposed activities will have “no effect” on listed species or critical habitat, or until Section 7 consultation has been completed. If the non-Federal applicant has not heard back from the Corps within 45 days, the applicant must still wait for notification from the Corps.

(d) As a result of formal or informal consultation with the FWS or NMFS the district engineer may add species-specific regional endangered species conditions to the NWPs.

(e) Authorization of an activity by a NWP does not authorize the “take” of a threatened or endangered species as defined under the ESA. In the absence of separate authorization (e.g., an ESA Section 10 Permit, a Biological Opinion with “incidental take” provisions, etc.) from the U.S. FWS or the NMFS, The Endangered Species Act prohibits any person subject to the jurisdiction of the United States to take a listed species, where "take" means to harass, harm, pursue, hunt, shoot, wound, kill, trap, capture, or collect, or to attempt to engage in any such conduct. The word “harm” in the definition of “take” means an act which actually kills or injures wildlife. Such an act may include significant habitat modification or degradation where it actually kills or injures wildlife by significantly impairing essential behavioral patterns, including breeding, feeding or sheltering.



(f) Information on the location of threatened and endangered species and their critical habitat can be obtained directly from the offices of the U.S. FWS and NMFS or their world wide web pages at <http://www.fws.gov/> or <http://www.fws.gov/ipac> and <http://www.noaa.gov/fisheries.html> respectively.

19. Migratory Birds and Bald and Golden Eagles. The permittee is responsible for obtaining any “take” permits required under the U.S. Fish and Wildlife Service’s regulations governing compliance with the Migratory Bird Treaty Act or the Bald and Golden Eagle Protection Act. The permittee should contact the appropriate local office of the U.S. Fish and Wildlife Service to determine if such “take” permits are required for a particular activity.

20. Historic Properties. (a) In cases where the district engineer determines that the activity may affect properties listed, or eligible for listing, in the National Register of Historic Places, the activity is not authorized, until the requirements of Section 106 of the National Historic Preservation Act (NHPA) have been satisfied.

(b) Federal permittees should follow their own procedures for complying with the requirements of Section 106 of the National Historic Preservation Act. Federal permittees must provide the district engineer with the appropriate documentation to demonstrate compliance with those requirements. The district engineer will review the documentation and determine whether it is sufficient to address section 106 compliance for the NWP activity, or whether additional section 106 consultation is necessary.

\* (c) Non-federal permittees must submit a pre-construction notification to the district engineer if the authorized activity may have the potential to cause effects to any historic properties listed on, determined to be eligible for listing on, or potentially eligible for listing on the National Register of Historic Places, including previously unidentified properties. For such activities, the pre-construction notification must state which historic properties may be affected by the proposed work or include a vicinity map indicating the location of the historic properties or the potential for the presence of historic properties. Assistance regarding information on the location of or potential for the presence of historic resources can be sought from the State Historic Preservation Officer or Tribal Historic Preservation Officer, as appropriate, and the National Register of Historic Places (see 33 CFR 330.4(g)). When reviewing pre-construction notifications, district engineers will comply with the current procedures for addressing the requirements of Section 106 of the National Historic Preservation Act. The district engineer shall make a reasonable and good faith effort to carry out appropriate identification efforts, which may include background research, consultation, oral history interviews, sample field investigation, and field survey. Based on the information submitted and these efforts, the district engineer shall determine whether the proposed activity has the potential to cause an effect on the historic properties. Where the non-Federal applicant has identified historic properties on which the activity may have the potential to cause effects and so notified the Corps, the non-Federal applicant shall not begin the activity until notified by the district engineer either that the activity has no potential to cause effects or that consultation under Section 106 of the NHPA has been completed.

(d) The district engineer will notify the prospective permittee within 45 days of receipt of a complete pre-construction notification whether NHPA Section 106 consultation is required. Section 106 consultation is not required when the Corps determines that the activity does not have the potential to cause effects on historic properties (see 36 CFR §800.3(a)). If NHPA

section 106 consultation is required and will occur, the district engineer will notify the non-Federal applicant that he or she cannot begin work until Section 106 consultation is completed. If the non-Federal applicant has not heard back from the Corps within 45 days, the applicant must still wait for notification from the Corps.

(e) Prospective permittees should be aware that section 110k of the NHPA (16 U.S.C. 470h-2(k)) prevents the Corps from granting a permit or other assistance to an applicant who, with intent to avoid the requirements of Section 106 of the NHPA, has intentionally significantly adversely affected a historic property to which the permit would relate, or having legal power to prevent it, allowed such significant adverse effect to occur, unless the Corps, after consultation with the Advisory Council on Historic Preservation (ACHP), determines that circumstances justify granting such assistance despite the adverse effect created or permitted by the applicant. If circumstances justify granting the assistance, the Corps is required to notify the ACHP and provide documentation specifying the circumstances, the degree of damage to the integrity of any historic properties affected, and proposed mitigation. This documentation must include any views obtained from the applicant, SHPO/THPO, appropriate Indian tribes if the undertaking occurs on or affects historic properties on tribal lands or affects properties of interest to those tribes, and other parties known to have a legitimate interest in the impacts to the permitted activity on historic properties.

21. Discovery of Previously Unknown Remains and Artifacts. If you discover any previously unknown historic, cultural or archeological remains and artifacts while accomplishing the activity authorized by this permit, you must immediately notify the district engineer of what you have found, and to the maximum extent practicable, avoid construction activities that may affect the remains and artifacts until the required coordination has been completed. The district engineer will initiate the Federal, Tribal and state coordination required to determine if the items or remains warrant a recovery effort or if the site is eligible for listing in the National Register of Historic Places.

22. Designated Critical Resource Waters. Critical resource waters include, NOAA-managed marine sanctuaries and marine monuments, and National Estuarine Research Reserves. The district engineer may designate, after notice and opportunity for public comment, additional waters officially designated by a state as having particular environmental or ecological significance, such as outstanding national resource waters or state natural heritage sites. The district engineer may also designate additional critical resource waters after notice and opportunity for public comment.

(a) Discharges of dredged or fill material into waters of the United States are not authorized by NWP 7, 12, 14, 16, 17, 21, 29, 31, 35, 39, 40, 42, 43, 44, 49, 50, 51, and 52 for any activity within, or directly affecting, critical resource waters, including wetlands adjacent to such waters.

(b) For NWPs 3, 8, 10, 13, 15, 18, 19, 22, 23, 25, 27, 28, 30, 33, 34, 36, 37, and 38, notification is required in accordance with general condition 31, for any activity proposed in the designated critical resource waters including wetlands adjacent to those waters. The district engineer may authorize activities under these NWPs only after it is determined that the impacts to the critical resource waters will be no more than minimal.



23. Mitigation. The district engineer will consider the following factors when determining appropriate and practicable mitigation necessary to ensure that adverse effects on the aquatic environment are minimal:

(a) The activity must be designed and constructed to avoid and minimize adverse effects, both temporary and permanent, to waters of the United States to the maximum extent practicable at the project site (i.e., on site).

(b) Mitigation in all its forms (avoiding, minimizing, rectifying, reducing, or compensating for resource losses) will be required to the extent necessary to ensure that the adverse effects to the aquatic environment are minimal.

(c) Compensatory mitigation at a minimum one-for-one ratio will be required for all wetland losses that exceed 1/10-acre and require pre-construction notification, unless the district engineer determines in writing that either some other form of mitigation would be more environmentally appropriate or the adverse effects of the proposed activity are minimal, and provides a project-specific waiver of this requirement. For wetland losses of 1/10-acre or less that require pre-construction notification, the district engineer may determine on a case-by-case basis that compensatory mitigation is required to ensure that the activity results in minimal adverse effects on the aquatic environment. Compensatory mitigation projects provided to offset losses of aquatic resources must comply with the applicable provisions of 33 CFR part 332.

(1) The prospective permittee is responsible for proposing an appropriate compensatory mitigation option if compensatory mitigation is necessary to ensure that the activity results in minimal adverse effects on the aquatic environment.

(2) Since the likelihood of success is greater and the impacts to potentially valuable uplands are reduced, wetland restoration should be the first compensatory mitigation option considered.

(3) If permittee-responsible mitigation is the proposed option, the prospective permittee is responsible for submitting a mitigation plan. A conceptual or detailed mitigation plan may be used by the district engineer to make the decision on the NWP verification request, but a final mitigation plan that addresses the applicable requirements of 33 CFR 332.4(c)(2) – (14) must be approved by the district engineer before the permittee begins work in waters of the United States, unless the district engineer determines that prior approval of the final mitigation plan is not practicable or not necessary to ensure timely completion of the required compensatory mitigation (see 33 CFR 332.3(k)(3)).

(4) If mitigation bank or in-lieu fee program credits are the proposed option, the mitigation plan only needs to address the baseline conditions at the impact site and the number of credits to be provided.

(5) Compensatory mitigation requirements (e.g., resource type and amount to be provided as compensatory mitigation, site protection, ecological performance standards, monitoring requirements) may be addressed through conditions added to the NWP authorization, instead of components of a compensatory mitigation plan.

(d) For losses of streams or other open waters that require pre-construction notification, the district engineer may require compensatory mitigation, such as stream rehabilitation, enhancement, or preservation, to ensure that the activity results in minimal adverse effects on the aquatic environment.

(e) Compensatory mitigation will not be used to increase the acreage losses allowed by the acreage limits of the NWPs. For example, if an NWP has an acreage limit of 1/2-acre, it cannot be used to authorize any project resulting in the loss of greater than 1/2-acre of waters of

the United States, even if compensatory mitigation is provided that replaces or restores some of the lost waters. However, compensatory mitigation can and should be used, as necessary, to ensure that a project already meeting the established acreage limits also satisfies the minimal impact requirement associated with the NWP.

(f) Compensatory mitigation plans for projects in or near streams or other open waters will normally include a requirement for the restoration or establishment, maintenance, and legal protection (e.g., conservation easements) of riparian areas next to open waters. In some cases, riparian areas may be the only compensatory mitigation required. Riparian areas should consist of native species. The width of the required riparian area will address documented water quality or aquatic habitat loss concerns. Normally, the riparian area will be 25 to 50 feet wide on each side of the stream, but the district engineer may require slightly wider riparian areas to address documented water quality or habitat loss concerns. If it is not possible to establish a riparian area on both sides of a stream, or if the waterbody is a lake or coastal waters, then restoring or establishing a riparian area along a single bank or shoreline may be sufficient. Where both wetlands and open waters exist on the project site, the district engineer will determine the appropriate compensatory mitigation (e.g., riparian areas and/or wetlands compensation) based on what is best for the aquatic environment on a watershed basis. In cases where riparian areas are determined to be the most appropriate form of compensatory mitigation, the district engineer may waive or reduce the requirement to provide wetland compensatory mitigation for wetland losses.

(g) Permittees may propose the use of mitigation banks, in-lieu fee programs, or separate permittee-responsible mitigation. For activities resulting in the loss of marine or estuarine resources, permittee-responsible compensatory mitigation may be environmentally preferable if there are no mitigation banks or in-lieu fee programs in the area that have marine or estuarine credits available for sale or transfer to the permittee. For permittee-responsible mitigation, the special conditions of the NWP verification must clearly indicate the party or parties responsible for the implementation and performance of the compensatory mitigation project, and, if required, its long-term management.

(h) Where certain functions and services of waters of the United States are permanently adversely affected, such as the conversion of a forested or scrub-shrub wetland to a herbaceous wetland in a permanently maintained utility line right-of-way, mitigation may be required to reduce the adverse effects of the project to the minimal level.

24. Safety of Impoundment Structures. To ensure that all impoundment structures are safely designed, the district engineer may require non-Federal applicants to demonstrate that the structures comply with established state dam safety criteria or have been designed by qualified persons. The district engineer may also require documentation that the design has been independently reviewed by similarly qualified persons, and appropriate modifications made to ensure safety.

25. Water Quality. Where States and authorized Tribes, or EPA where applicable, have not previously certified compliance of an NWP with CWA Section 401, individual 401 Water Quality Certification must be obtained or waived (see 33 CFR 330.4(c)). The district engineer or State or Tribe may require additional water quality management measures to ensure that the authorized activity does not result in more than minimal degradation of water quality.

26. Coastal Zone Management. In coastal states where an NWP has not previously received a state coastal zone management consistency concurrence, an individual state coastal zone management consistency concurrence must be obtained, or a presumption of concurrence must occur (see 33 CFR 330.4(d)). The district engineer or a State may require additional measures to ensure that the authorized activity is consistent with state coastal zone management requirements.

27. Regional and Case-By-Case Conditions. The activity must comply with any regional conditions that may have been added by the Division Engineer (see 33 CFR 330.4(e)) and with any case specific conditions added by the Corps or by the state, Indian Tribe, or U.S. EPA in its section 401 Water Quality Certification, or by the state in its Coastal Zone Management Act consistency determination.

28. Use of Multiple Nationwide Permits. The use of more than one NWP for a single and complete project is prohibited, except when the acreage loss of waters of the United States authorized by the NWPs does not exceed the acreage limit of the NWP with the highest specified acreage limit. For example, if a road crossing over tidal waters is constructed under NWP 14, with associated bank stabilization authorized by NWP 13, the maximum acreage loss of waters of the United States for the total project cannot exceed 1/3-acre.

29. Transfer of Nationwide Permit Verifications. If the permittee sells the property associated with a nationwide permit verification, the permittee may transfer the nationwide permit verification to the new owner by submitting a letter to the appropriate Corps district office to validate the transfer. A copy of the nationwide permit verification must be attached to the letter, and the letter must contain the following statement and signature:

“When the structures or work authorized by this nationwide permit are still in existence at the time the property is transferred, the terms and conditions of this nationwide permit, including any special conditions, will continue to be binding on the new owner(s) of the property. To validate the transfer of this nationwide permit and the associated liabilities associated with compliance with its terms and conditions, have the transferee sign and date below.”

\_\_\_\_\_  
(Transferee)

\_\_\_\_\_  
(Date)

\* 30. Compliance Certification. Each permittee who receives an NWP verification letter from the Corps must provide a signed certification documenting completion of the authorized activity and any required compensatory mitigation. The success of any required permittee-responsible mitigation, including the achievement of ecological performance standards, will be addressed separately by the district engineer. The Corps will provide the permittee the certification document with the NWP verification letter. The certification document will include:

(a) A statement that the authorized work was done in accordance with the NWP authorization, including any general, regional, or activity-specific conditions;

(b) A statement that the implementation of any required compensatory mitigation was completed in accordance with the permit conditions. If credits from a mitigation bank or in-lieu fee program are used to satisfy the compensatory mitigation requirements, the certification must include the documentation required by 33 CFR 332.3(1)(3) to confirm that the permittee secured the appropriate number and resource type of credits; and

(c) The signature of the permittee certifying the completion of the work and mitigation.

\* 31. Pre-Construction Notification. (a) Timing. Where required by the terms of the NWP, the prospective permittee must notify the district engineer by submitting a pre-construction notification (PCN) as early as possible. The district engineer must determine if the PCN is complete within 30 calendar days of the date of receipt and, if the PCN is determined to be incomplete, notify the prospective permittee within that 30 day period to request the additional information necessary to make the PCN complete. The request must specify the information needed to make the PCN complete. As a general rule, district engineers will request additional information necessary to make the PCN complete only once. However, if the prospective permittee does not provide all of the requested information, then the district engineer will notify the prospective permittee that the PCN is still incomplete and the PCN review process will not commence until all of the requested information has been received by the district engineer. The prospective permittee shall not begin the activity until either:

(1) He or she is notified in writing by the district engineer that the activity may proceed under the NWP with any special conditions imposed by the district or division engineer; or

(2) 45 calendar days have passed from the district engineer's receipt of the complete PCN and the prospective permittee has not received written notice from the district or division engineer. However, if the permittee was required to notify the Corps pursuant to general condition 18 that listed species or critical habitat might be affected or in the vicinity of the project, or to notify the Corps pursuant to general condition 20 that the activity may have the potential to cause effects to historic properties, the permittee cannot begin the activity until receiving written notification from the Corps that there is "no effect" on listed species or "no potential to cause effects" on historic properties, or that any consultation required under Section 7 of the Endangered Species Act (see 33 CFR 330.4(f)) and/or Section 106 of the National Historic Preservation (see 33 CFR 330.4(g)) has been completed. Also, work cannot begin under NWPs 21, 49, or 50 until the permittee has received written approval from the Corps. If the proposed activity requires a written waiver to exceed specified limits of an NWP, the permittee may not begin the activity until the district engineer issues the waiver. If the district or division engineer notifies the permittee in writing that an individual permit is required within 45 calendar days of receipt of a complete PCN, the permittee cannot begin the activity until an individual permit has been obtained. Subsequently, the permittee's right to proceed under the NWP may be modified, suspended, or revoked only in accordance with the procedure set forth in 33 CFR 330.5(d)(2).

(b) Contents of Pre-Construction Notification: The PCN must be in writing and include the following information:

(1) Name, address and telephone numbers of the prospective permittee;

(2) Location of the proposed project;

(3) A description of the proposed project; the project's purpose; direct and indirect adverse environmental effects the project would cause, including the anticipated amount of loss of water of the United States expected to result from the NWP activity, in acres, linear feet, or other appropriate unit of measure; any other NWP(s), regional general permit(s), or individual permit(s) used or intended to be used to authorize any part of the proposed project or any related activity. The description should be sufficiently detailed to allow the district engineer to determine that the adverse effects of the project will be minimal and to determine the need for compensatory mitigation. Sketches should be provided when necessary to show that the activity complies with the terms of the NWP. (Sketches usually clarify the project and when provided results in a quicker decision. Sketches should contain sufficient detail to provide an illustrative description of the proposed activity (e.g., a conceptual plan), but do not need to be detailed engineering plans);

(4) The PCN must include a delineation of wetlands, other special aquatic sites, and other waters, such as lakes and ponds, and perennial, intermittent, and ephemeral streams, on the project site. Wetland delineations must be prepared in accordance with the current method required by the Corps. The permittee may ask the Corps to delineate the special aquatic sites and other waters on the project site, but there may be a delay if the Corps does the delineation, especially if the project site is large or contains many waters of the United States. Furthermore, the 45 day period will not start until the delineation has been submitted to or completed by the Corps, as appropriate;

(5) If the proposed activity will result in the loss of greater than 1/10-acre of wetlands and a PCN is required, the prospective permittee must submit a statement describing how the mitigation requirement will be satisfied, or explaining why the adverse effects are minimal and why compensatory mitigation should not be required. As an alternative, the prospective permittee may submit a conceptual or detailed mitigation plan.

(6) If any listed species or designated critical habitat might be affected or is in the vicinity of the project, or if the project is located in designated critical habitat, for non-Federal applicants the PCN must include the name(s) of those endangered or threatened species that might be affected by the proposed work or utilize the designated critical habitat that may be affected by the proposed work. Federal applicants must provide documentation demonstrating compliance with the Endangered Species Act; and

(7) For an activity that may affect a historic property listed on, determined to be eligible for listing on, or potentially eligible for listing on, the National Register of Historic Places, for non-Federal applicants the PCN must state which historic property may be affected by the proposed work or include a vicinity map indicating the location of the historic property. Federal applicants must provide documentation demonstrating compliance with Section 106 of the National Historic Preservation Act.

(c) Form of Pre-Construction Notification: The standard individual permit application form (Form ENG 4345) may be used, but the completed application form must clearly indicate that it is a PCN and must include all of the information required in paragraphs (b)(1) through (7) of this general condition. A letter containing the required information may also be used.

(d) Agency Coordination: (1) The district engineer will consider any comments from Federal and state agencies concerning the proposed activity's compliance with the terms and conditions of the NWPs and the need for mitigation to reduce the project's adverse environmental effects to a minimal level.



(2) For all NWP activities that require pre-construction notification and result in the loss of greater than 1/2-acre of waters of the United States, for NWP 21, 29, 39, 40, 42, 43, 44, 50, 51, and 52 activities that require pre-construction notification and will result in the loss of greater than 300 linear feet of intermittent and ephemeral stream bed, and for all NWP 48 activities that require pre-construction notification, the district engineer will immediately provide (e.g., via e-mail, facsimile transmission, overnight mail, or other expeditious manner) a copy of the complete PCN to the appropriate Federal or state offices (U.S. FWS, state natural resource or water quality agency, EPA, State Historic Preservation Officer (SHPO) or Tribal Historic Preservation Office (THPO), and, if appropriate, the NMFS). With the exception of NWP 37, these agencies will have 10 calendar days from the date the material is transmitted to telephone or fax the district engineer notice that they intend to provide substantive, site-specific comments. The comments must explain why the agency believes the adverse effects will be more than minimal. If so contacted by an agency, the district engineer will wait an additional 15 calendar days before making a decision on the pre-construction notification. The district engineer will fully consider agency comments received within the specified time frame concerning the proposed activity's compliance with the terms and conditions of the NWPs, including the need for mitigation to ensure the net adverse environmental effects to the aquatic environment of the proposed activity are minimal. The district engineer will provide no response to the resource agency, except as provided below. The district engineer will indicate in the administrative record associated with each pre-construction notification that the resource agencies' concerns were considered. For NWP 37, the emergency watershed protection and rehabilitation activity may proceed immediately in cases where there is an unacceptable hazard to life or a significant loss of property or economic hardship will occur. The district engineer will consider any comments received to decide whether the NWP 37 authorization should be modified, suspended, or revoked in accordance with the procedures at 33 CFR 330.5.

(3) In cases of where the prospective permittee is not a Federal agency, the district engineer will provide a response to NMFS within 30 calendar days of receipt of any Essential Fish Habitat conservation recommendations, as required by Section 305(b)(4)(B) of the Magnuson-Stevens Fishery Conservation and Management Act.

(4) Applicants are encouraged to provide the Corps with either electronic files or multiple copies of pre-construction notifications to expedite agency coordination.

#### D. District Engineer's Decision

1. In reviewing the PCN for the proposed activity, the district engineer will determine whether the activity authorized by the NWP will result in more than minimal individual or cumulative adverse environmental effects or may be contrary to the public interest. For a linear project, this determination will include an evaluation of the individual crossings to determine whether they individually satisfy the terms and conditions of the NWP(s), as well as the cumulative effects caused by all of the crossings authorized by NWP. If an applicant requests a waiver of the 300 linear foot limit on impacts to intermittent or ephemeral streams or of an otherwise applicable limit, as provided for in NWPs 13, 21, 29, 36, 39, 40, 42, 43, 44, 50, 51 or 52, the district engineer will only grant the waiver upon a written determination that the NWP activity will result in minimal adverse effects. When making minimal effects determinations the district engineer will consider the direct and indirect effects caused by the NWP activity. The district engineer will also consider site specific factors, such as the environmental setting in the

vicinity of the NWP activity, the type of resource that will be affected by the NWP activity, the functions provided by the aquatic resources that will be affected by the NWP activity, the degree or magnitude to which the aquatic resources perform those functions, the extent that aquatic resource functions will be lost as a result of the NWP activity (e.g., partial or complete loss), the duration of the adverse effects (temporary or permanent), the importance of the aquatic resource functions to the region (e.g., watershed or ecoregion), and mitigation required by the district engineer. If an appropriate functional assessment method is available and practicable to use, that assessment method may be used by the district engineer to assist in the minimal adverse effects determination. The district engineer may add case-specific special conditions to the NWP authorization to address site-specific environmental concerns.

2. If the proposed activity requires a PCN and will result in a loss of greater than 1/10-acre of wetlands, the prospective permittee should submit a mitigation proposal with the PCN. Applicants may also propose compensatory mitigation for projects with smaller impacts. The district engineer will consider any proposed compensatory mitigation the applicant has included in the proposal in determining whether the net adverse environmental effects to the aquatic environment of the proposed activity are minimal. The compensatory mitigation proposal may be either conceptual or detailed. If the district engineer determines that the activity complies with the terms and conditions of the NWP and that the adverse effects on the aquatic environment are minimal, after considering mitigation, the district engineer will notify the permittee and include any activity-specific conditions in the NWP verification the district engineer deems necessary. Conditions for compensatory mitigation requirements must comply with the appropriate provisions at 33 CFR 332.3(k). The district engineer must approve the final mitigation plan before the permittee commences work in waters of the United States, unless the district engineer determines that prior approval of the final mitigation plan is not practicable or not necessary to ensure timely completion of the required compensatory mitigation. If the prospective permittee elects to submit a compensatory mitigation plan with the PCN, the district engineer will expeditiously review the proposed compensatory mitigation plan. The district engineer must review the proposed compensatory mitigation plan within 45 calendar days of receiving a complete PCN and determine whether the proposed mitigation would ensure no more than minimal adverse effects on the aquatic environment. If the net adverse effects of the project on the aquatic environment (after consideration of the compensatory mitigation proposal) are determined by the district engineer to be minimal, the district engineer will provide a timely written response to the applicant. The response will state that the project can proceed under the terms and conditions of the NWP, including any activity-specific conditions added to the NWP authorization by the district engineer.

3. If the district engineer determines that the adverse effects of the proposed work are more than minimal, then the district engineer will notify the applicant either: (a) That the project does not qualify for authorization under the NWP and instruct the applicant on the procedures to seek authorization under an individual permit; (b) that the project is authorized under the NWP subject to the applicant's submission of a mitigation plan that would reduce the adverse effects on the aquatic environment to the minimal level; or (c) that the project is authorized under the NWP with specific modifications or conditions. Where the district engineer determines that mitigation is required to ensure no more than minimal adverse effects occur to the aquatic environment, the activity will be authorized within the 45-day PCN period, with activity-specific

conditions that state the mitigation requirements. The authorization will include the necessary conceptual or detailed mitigation or a requirement that the applicant submit a mitigation plan that would reduce the adverse effects on the aquatic environment to the minimal level. When mitigation is required, no work in waters of the United States may occur until the district engineer has approved a specific mitigation plan or has determined that prior approval of a final mitigation plan is not practicable or not necessary to ensure timely completion of the required compensatory mitigation.

### **FURTHER INFORMATION**

1. District Engineers have authority to determine if an activity complies with the terms and conditions of an NWP.
2. NWPs do not obviate the need to obtain other federal, state, or local permits, approvals, or authorizations required by law.
3. NWPs do not grant any property rights or exclusive privileges.
4. NWPs do not authorize any injury to the property or rights of others.
5. NWPs do not authorize interference with any existing or proposed Federal project.

### **DEFINITIONS**

Best management practices (BMPs): Policies, practices, procedures, or structures implemented to mitigate the adverse environmental effects on surface water quality resulting from development. BMPs are categorized as structural or non-structural.

Compensatory mitigation: The restoration (re-establishment or rehabilitation), establishment (creation), enhancement, and/or in certain circumstances preservation of aquatic resources for the purposes of offsetting unavoidable adverse impacts which remain after all appropriate and practicable avoidance and minimization has been achieved.

Currently serviceable: Useable as is or with some maintenance, but not so degraded as to essentially require reconstruction.

Direct effects: Effects that are caused by the activity and occur at the same time and place.

Discharge: The term “discharge” means any discharge of dredged or fill material.

Enhancement: The manipulation of the physical, chemical, or biological characteristics of an aquatic resource to heighten, intensify, or improve a specific aquatic resource function(s). Enhancement results in the gain of selected aquatic resource function(s), but may also lead to a decline in other aquatic resource function(s). Enhancement does not result in a gain in aquatic resource area.

Ephemeral stream: An ephemeral stream has flowing water only during, and for a short duration after, precipitation events in a typical year. Ephemeral stream beds are located above the water table year-round. Groundwater is not a source of water for the stream. Runoff from rainfall is the primary source of water for stream flow.

Establishment (creation): The manipulation of the physical, chemical, or biological characteristics present to develop an aquatic resource that did not previously exist at an upland site. Establishment results in a gain in aquatic resource area.

High Tide Line: The line of intersection of the land with the water’s surface at the maximum height reached by a rising tide. The high tide line may be determined, in the absence



of actual data, by a line of oil or scum along shore objects, a more or less continuous deposit of fine shell or debris on the foreshore or berm, other physical markings or characteristics, vegetation lines, tidal gages, or other suitable means that delineate the general height reached by a rising tide. The line encompasses spring high tides and other high tides that occur with periodic frequency but does not include storm surges in which there is a departure from the normal or predicted reach of the tide due to the piling up of water against a coast by strong winds such as those accompanying a hurricane or other intense storm.

Historic Property: Any prehistoric or historic district, site (including archaeological site), building, structure, or other object included in, or eligible for inclusion in, the National Register of Historic Places maintained by the Secretary of the Interior. This term includes artifacts, records, and remains that are related to and located within such properties. The term includes properties of traditional religious and cultural importance to an Indian tribe or Native Hawaiian organization and that meet the National Register criteria (36 CFR part 60).

Independent utility: A test to determine what constitutes a single and complete non-linear project in the Corps regulatory program. A project is considered to have independent utility if it would be constructed absent the construction of other projects in the project area. Portions of a multi-phase project that depend upon other phases of the project do not have independent utility. Phases of a project that would be constructed even if the other phases were not built can be considered as separate single and complete projects with independent utility.

Indirect effects: Effects that are caused by the activity and are later in time or farther removed in distance, but are still reasonably foreseeable.

Intermittent stream: An intermittent stream has flowing water during certain times of the year, when groundwater provides water for stream flow. During dry periods, intermittent streams may not have flowing water. Runoff from rainfall is a supplemental source of water for stream flow.

Loss of waters of the United States: Waters of the United States that are permanently adversely affected by filling, flooding, excavation, or drainage because of the regulated activity. Permanent adverse effects include permanent discharges of dredged or fill material that change an aquatic area to dry land, increase the bottom elevation of a waterbody, or change the use of a waterbody. The acreage of loss of waters of the United States is a threshold measurement of the impact to jurisdictional waters for determining whether a project may qualify for an NWP; it is not a net threshold that is calculated after considering compensatory mitigation that may be used to offset losses of aquatic functions and services. The loss of stream bed includes the linear feet of stream bed that is filled or excavated. Waters of the United States temporarily filled, flooded, excavated, or drained, but restored to pre-construction contours and elevations after construction, are not included in the measurement of loss of waters of the United States. Impacts resulting from activities eligible for exemptions under Section 404(f) of the Clean Water Act are not considered when calculating the loss of waters of the United States.

Non-tidal wetland: A non-tidal wetland is a wetland that is not subject to the ebb and flow of tidal waters. The definition of a wetland can be found at 33 CFR 328.3(b). Non-tidal wetlands contiguous to tidal waters are located landward of the high tide line (i.e., spring high tide line).

Open water: For purposes of the NWPs, an open water is any area that in a year with normal patterns of precipitation has water flowing or standing above ground to the extent that an ordinary high water mark can be determined. Aquatic vegetation within the area of standing or

flowing water is either non-emergent, sparse, or absent. Vegetated shallows are considered to be open waters. Examples of “open waters” include rivers, streams, lakes, and ponds.

Ordinary High Water Mark: An ordinary high water mark is a line on the shore established by the fluctuations of water and indicated by physical characteristics, or by other appropriate means that consider the characteristics of the surrounding areas (see 33 CFR 328.3(e)).

Perennial stream: A perennial stream has flowing water year-round during a typical year. The water table is located above the stream bed for most of the year. Groundwater is the primary source of water for stream flow. Runoff from rainfall is a supplemental source of water for stream flow.

Practicable: Available and capable of being done after taking into consideration cost, existing technology, and logistics in light of overall project purposes.

Pre-construction notification: A request submitted by the project proponent to the Corps for confirmation that a particular activity is authorized by nationwide permit. The request may be a permit application, letter, or similar document that includes information about the proposed work and its anticipated environmental effects. Pre-construction notification may be required by the terms and conditions of a nationwide permit, or by regional conditions. A pre-construction notification may be voluntarily submitted in cases where pre-construction notification is not required and the project proponent wants confirmation that the activity is authorized by nationwide permit.

Preservation: The removal of a threat to, or preventing the decline of, aquatic resources by an action in or near those aquatic resources. This term includes activities commonly associated with the protection and maintenance of aquatic resources through the implementation of appropriate legal and physical mechanisms. Preservation does not result in a gain of aquatic resource area or functions.

Re-establishment: The manipulation of the physical, chemical, or biological characteristics of a site with the goal of returning natural/historic functions to a former aquatic resource. Re-establishment results in rebuilding a former aquatic resource and results in a gain in aquatic resource area and functions.

Rehabilitation: The manipulation of the physical, chemical, or biological characteristics of a site with the goal of repairing natural/historic functions to a degraded aquatic resource. Rehabilitation results in a gain in aquatic resource function, but does not result in a gain in aquatic resource area.

Restoration: The manipulation of the physical, chemical, or biological characteristics of a site with the goal of returning natural/historic functions to a former or degraded aquatic resource. For the purpose of tracking net gains in aquatic resource area, restoration is divided into two categories: re-establishment and rehabilitation.

Riffle and pool complex: Riffle and pool complexes are special aquatic sites under the 404(b)(1) Guidelines. Riffle and pool complexes sometimes characterize steep gradient sections of streams. Such stream sections are recognizable by their hydraulic characteristics. The rapid movement of water over a coarse substrate in riffles results in a rough flow, a turbulent surface, and high dissolved oxygen levels in the water. Pools are deeper areas associated with riffles. A slower stream velocity, a streaming flow, a smooth surface, and a finer substrate characterize pools.

Riparian areas: Riparian areas are lands adjacent to streams, lakes, and estuarine-marine shorelines. Riparian areas are transitional between terrestrial and aquatic ecosystems, through

which surface and subsurface hydrology connects riverine, lacustrine, estuarine, and marine waters with their adjacent wetlands, non-wetland waters, or uplands. Riparian areas provide a variety of ecological functions and services and help improve or maintain local water quality. (See general condition 23.)

Shellfish seeding: The placement of shellfish seed and/or suitable substrate to increase shellfish production. Shellfish seed consists of immature individual shellfish or individual shellfish attached to shells or shell fragments (i.e., spat on shell). Suitable substrate may consist of shellfish shells, shell fragments, or other appropriate materials placed into waters for shellfish habitat.

Single and complete linear project: A linear project is a project constructed for the purpose of getting people, goods, or services from a point of origin to a terminal point, which often involves multiple crossings of one or more waterbodies at separate and distant locations. The term “single and complete project” is defined as that portion of the total linear project proposed or accomplished by one owner/developer or partnership or other association of owners/developers that includes all crossings of a single water of the United States (i.e., a single waterbody) at a specific location. For linear projects crossing a single or multiple waterbodies several times at separate and distant locations, each crossing is considered a single and complete project for purposes of NWP authorization. However, individual channels in a braided stream or river, or individual arms of a large, irregularly shaped wetland or lake, etc., are not separate waterbodies, and crossings of such features cannot be considered separately.

Single and complete non-linear project: For non-linear projects, the term “single and complete project” is defined at 33 CFR 330.2(i) as the total project proposed or accomplished by one owner/developer or partnership or other association of owners/developers. A single and complete non-linear project must have independent utility (see definition of “independent utility”). Single and complete non-linear projects may not be “piecemealed” to avoid the limits in an NWP authorization.

Stormwater management: Stormwater management is the mechanism for controlling stormwater runoff for the purposes of reducing downstream erosion, water quality degradation, and flooding and mitigating the adverse effects of changes in land use on the aquatic environment.

Stormwater management facilities: Stormwater management facilities are those facilities, including but not limited to, stormwater retention and detention ponds and best management practices, which retain water for a period of time to control runoff and/or improve the quality (i.e., by reducing the concentration of nutrients, sediments, hazardous substances and other pollutants) of stormwater runoff.

Stream bed: The substrate of the stream channel between the ordinary high water marks. The substrate may be bedrock or inorganic particles that range in size from clay to boulders. Wetlands contiguous to the stream bed, but outside of the ordinary high water marks, are not considered part of the stream bed.

Stream channelization: The manipulation of a stream’s course, condition, capacity, or location that causes more than minimal interruption of normal stream processes. A channelized stream remains a water of the United States.

Structure: An object that is arranged in a definite pattern of organization. Examples of structures include, without limitation, any pier, boat dock, boat ramp, wharf, dolphin, weir, boom, breakwater, bulkhead, revetment, riprap, jetty, artificial island, artificial reef, permanent

mooring structure, power transmission line, permanently moored floating vessel, piling, aid to navigation, or any other manmade obstacle or obstruction.

Tidal wetland: A tidal wetland is a wetland (i.e., water of the United States) that is inundated by tidal waters. The definitions of a wetland and tidal waters can be found at 33 CFR 328.3(b) and 33 CFR 328.3(f), respectively. Tidal waters rise and fall in a predictable and measurable rhythm or cycle due to the gravitational pulls of the moon and sun. Tidal waters end where the rise and fall of the water surface can no longer be practically measured in a predictable rhythm due to masking by other waters, wind, or other effects. Tidal wetlands are located channelward of the high tide line, which is defined at 33 CFR 328.3(d).

Vegetated shallows: Vegetated shallows are special aquatic sites under the 404(b)(1) Guidelines. They are areas that are permanently inundated and under normal circumstances have rooted aquatic vegetation, such as seagrasses in marine and estuarine systems and a variety of vascular rooted plants in freshwater systems.

Waterbody: For purposes of the NWP, a waterbody is a jurisdictional water of the United States. If a jurisdictional wetland is adjacent – meaning bordering, contiguous, or neighboring – to a waterbody determined to be a water of the United States under 33 CFR 328.3(a)(1)-(6), that waterbody and its adjacent wetlands are considered together as a single aquatic unit (see 33 CFR 328.4(c)(2)). Examples of “waterbodies” include streams, rivers, lakes, ponds, and wetlands.

**Final Regional Conditions 2012**

*NOTICE ABOUT WEB LINKS IN THIS DOCUMENT:*

*The web links (both internal to our District and any external links to collaborating agencies) in this document are valid at the time of publication. However, the Wilmington District Regulatory Program web page addresses, as with other agency web sites, may change over the timeframe of the five-year Nationwide Permit renewal cycle, in response to policy mandates or technology advances. While we will make every effort to check on the integrity of our web links and provide re-direct pages whenever possible, we ask that you report any broken links to us so we can keep the page information current and usable. We apologize in advanced for any broken links that you may encounter, and we ask that you navigate from the regulatory home page (wetlands and stream permits) of the Wilmington District Corps of Engineers, to the “Permits” section of our web site to find links for pages that cannot be found by clicking directly on the listed web link in this document.*

**Final 2012 Regional Conditions for Nationwide Permits (NWP) in the  
Wilmington District**

**1.0 Excluded Waters**

The Corps has identified waters that will be excluded from the use of all NWP’s during certain timeframes. These waters are:

**1.1 Anadromous Fish Spawning Areas**

Waters of the United States identified by either the North Carolina Division of Marine Fisheries (NCDMF) or the North Carolina Wildlife Resources Commission (NCWRC) as anadromous fish spawning areas are excluded during the period between February 15 and June 30, without prior written approval from NCDMF or NCWRC and the Corps.

**1.2 Trout Waters Moratorium**

Waters of the United States in the twenty-five designated trout counties of North Carolina are excluded during the period between October 15 and April 15 without prior written approval from the NCWRC. (See Section 2.7 for a list of the twenty-five trout counties).

**1.3 Sturgeon Spawning Areas as Designated by the National Marine Fisheries Service (NMFS)**

Waters of the United States designated as sturgeon spawning areas are excluded during the period between February 1 and June 30, without prior written approval from the NMFS.

**\* 2.0 Waters Requiring Additional Notification**

The Corps has identified waters that will be subject to additional notification requirements for activities authorized by all NWP's. These waters are:

**\* 2.1 Western NC Counties that Drain to Designated Critical Habitat**

For proposed activities within Waters of the U.S. that require a Pre-Construction Notification pursuant to General Condition 31 (PCN) and are located in the sixteen counties listed below, applicants must provide a copy of the PCN to the US Fish and Wildlife Service, 160 Zillicoa Street, Asheville, North Carolina 28801. This PCN must be sent concurrently to the US Fish and Wildlife Service and the Corps Asheville Regulatory Field Office. Please see General Condition 18 for specific notification requirements related to Federally Endangered Species and the following website for information on the location of designated critical habitat.

Counties with tributaries that drain to designated critical habitat that require notification to the Asheville US Fish and Wildlife Service: Avery, Cherokee, Forsyth, Graham, Haywood, Henderson, Jackson, Macon Mecklenburg, Mitchell, Stokes, Surry, Swain, Transylvania, Union and Yancey.

Website and office addresses for Endangered Species Act Information:

The Wilmington District has developed the following website for applicants which provides guidelines on how to review linked websites and maps in order to fulfill NWP general condition 18 requirements: <http://www.saw.usace.army.mil/wetlands/ESA>

Applicants who do not have internet access may contact the appropriate US Fish and Wildlife Service offices listed below or the US Army Corps of Engineers at (910) 251- 4633:

US Fish and Wildlife Service  
Asheville Field Office  
160 Zillicoa Street  
Asheville, NC 28801  
Telephone: (828) 258-3939

Asheville US Fish and Wildlife Service Office counties: All counties west of and including Anson, Stanly, Davidson, Forsyth and Stokes Counties

US Fish and Wildlife Service  
Raleigh Field Office  
Post Office Box 33726  
Raleigh, NC 27636-3726  
Telephone: (919) 856-4520

Raleigh US Fish and Wildlife Service Office counties: all counties east of and including Richmond, Montgomery, Randolph, Guilford, and Rockingham Counties.



**\* 2.2 Special Designation Waters**

Prior to the use of any NWP in any of the following identified waters and contiguous wetlands in North Carolina, applicants must comply with Nationwide Permit General Condition 31 (PCN). The North Carolina waters and contiguous wetlands that require additional notification requirements are:

“Outstanding Resource Waters” (ORW) or “High Quality Waters” (HQW) as designated by the North Carolina Environmental Management Commission; “Inland Primary Nursery Areas” (IPNA) as designated by the NCWRC; “Contiguous Wetlands” as defined by the North Carolina Environmental Management Commission; or “Primary Nursery Areas” (PNA) as designated by the North Carolina Marine Fisheries Commission.

**2.3 Coastal Area Management Act (CAMA) Areas of Environmental Concern**

Non-federal applicants for any NWP in a designated “Area of Environmental Concern” (AEC) in the twenty (20) counties of Eastern North Carolina covered by the North Carolina Coastal Area Management Act (CAMA) must also obtain the required CAMA permit. Development activities for non-federal projects may not commence until a copy of the approved CAMA permit is furnished to the appropriate Wilmington District Regulatory Field Office (Wilmington Field Office – 69 Darlington Avenue, Wilmington, NC 28403 or Washington Field Office – 2407 West 5th Street, Washington, NC 27889).

**\* 2.4 Barrier Islands**

Prior to the use of any NWP on a barrier island of North Carolina, applicants must comply with Nationwide Permit General Condition 31 (PCN).

**\* 2.5 Mountain or Piedmont Bogs**

Prior to the use of any NWP in a Bog classified by the North Carolina Wetland Assessment Methodology (NCWAM), applicants shall comply with Nationwide Permit General Condition 31 (PCN). The latest version of NCWAM is located on the NC DWQ web site at: <http://portal.ncdenr.org/web/wq/swp/ws/pdu/ncwam> .

**\* 2.6 Animal Waste Facilities**

Prior to use of any NWP for construction of animal waste facilities in waters of the US, including wetlands, applicants shall comply with Nationwide Permit General Condition 31 (PCN).

**\* 2.7 Trout Waters**

Prior to any discharge of dredge or fill material into streams or waterbodies within the twenty-five (25) designated trout counties of North Carolina, the applicant shall comply with Nationwide Permit General Condition 31 (PCN). The applicant shall also provide a copy of the notification to the appropriate NCWRC office to facilitate the determination of any potential

impacts to designated Trout Waters. Notification to the Corps of Engineers will include a statement with the name of the NCWRC biologist contacted, the date of the notification, the location of work, a delineation of wetlands, a discussion of alternatives to working in the mountain trout waters, why alternatives were not selected, and a plan to provide compensatory mitigation for all unavoidable adverse impacts to mountain trout waters.

NCWRC and NC Trout Counties

Western Piedmont Region Coordinator	Alleghany	Caldwell	Watauga
20830 Great Smoky Mtn. Expressway	Ashe	Mitchell	Wilkes
Waynesville, NC 28786	Avery	Stokes	
Telephone: (828) 452-2546	Burke	Surry	

Mountain Region Coordinator	Buncombe	Henderson	Polk
20830 Great Smoky Mtn. Expressway	Cherokee	Jackson	Rutherford
Waynesville, NC 28786	Clay	Macon	Swain
Telephone: (828) 452-2546	Graham	Madison	Transylvania
Fax: (828) 452-7772	Haywood	McDowell	Yancey

**3.0 List of Corps Regional Conditions for All Nationwide Permits**

The following conditions apply to all Nationwide Permits in the Wilmington District:

**3.1 Limitation of Loss of Perennial Stream Bed**

NWPs may not be used for activities that may result in the loss or degradation of greater than 300 total linear feet of perennial, intermittent or ephemeral stream, unless the District Commander has waived the 300 linear foot limit for ephemeral and intermittent streams on a case-by-case basis and he determines that the proposed activity will result in minimal individual and cumulative adverse impacts to the aquatic environment. Loss of stream includes the linear feet of stream bed that is filled, excavated, or flooded by the proposed activity. Waivers for the loss of ephemeral and intermittent streams must be in writing and documented by appropriate/accepted stream quality assessments\*. This waiver only applies to the 300 linear feet threshold for NWPs.

\*NOTE: Applicants should utilize the most current methodology prescribed by Wilmington District to assess stream function and quality. Information can be found at:

<http://www.saw.usace.army.mil/wetlands/permits/nwp/nwp2012> (see “Quick Links”)



### **3.2 Mitigation for Loss of Stream Bed**

For any NWP that results in a loss of more than 150 linear feet of perennial and/or ephemeral/intermittent stream, the applicant shall provide a mitigation proposal to compensate for more than minimal individual and cumulative adverse impacts to the aquatic environment. For stream losses less than 150 linear feet, that require a PCN, the District Commander may determine, on a case-by-case basis that compensatory mitigation is required to ensure that the activity results in minimal adverse effect on the aquatic environment.

### **3.3 Pre-construction Notification for Loss of Streambed Exceeding 150 Feet.**

Prior to use of any NWP for any activity which impacts more than 150 total linear feet of perennial stream or ephemeral/ intermittent stream, the applicant must comply with Nationwide Permit General Condition 31 (PCN). This applies to NWPs that do not have specific notification requirements. If a NWP has specific notification requirements, the requirements of the NWP should be followed.

### **3.4 Restriction on Use of Live Concrete**

For all NWPs which allow the use of concrete as a building material, live or fresh concrete, including bags of uncured concrete, may not come into contact with the water in or entering into waters of the US. Water inside coffer dams or casings that has been in contact with wet concrete shall only be returned to waters of the US when it is no longer poses a threat to aquatic organisms.

### **3.5 Requirements for Using Riprap for Bank Stabilization**

For all NWPs that allow for the use of riprap material for bank stabilization, the following measures shall be applied:

**3.5.1.** Filter cloth must be placed underneath the riprap as an additional requirement of its use in North Carolina waters.

**3.5.2.** The placement of riprap shall be limited to the areas depicted on submitted work plan drawings.

**3.5.3.** The riprap material shall be clean and free from loose dirt or any pollutant except in trace quantities that would not have an adverse environmental effect.

**3.5.4.** It shall be of a size sufficient to prevent its movement from the authorized alignment by natural forces under normal conditions.

**3.5.5.** The riprap material shall consist of clean rock or masonry material such as, but not limited to, granite, marl, or broken concrete.

**3.5.6.** A waiver from the specifications in this Regional Condition may be requested in writing. The waiver will only be issued if it can be demonstrated that the impacts of complying with this Regional condition would result in greater adverse impacts to the aquatic environment.

**3.6 Safe Passage Requirements for Culvert Placement**

For all NWP's that involve the construction/installation of culverts, measures will be included in the construction/installation that will promote the safe passage of fish and other aquatic organisms. The dimension, pattern, and profile of the stream above and below a pipe or culvert should not be modified by widening the stream channel or by reducing the depth of the stream in connection with the construction activity. The width, height, and gradient of a proposed culvert should be such as to pass the average historical low flow and spring flow without adversely altering flow velocity. Spring flow should be determined from gage data, if available. In the absence of such data, bankfull flow can be used as a comparable level.

In the twenty (20) counties of North Carolina designated as coastal counties by the Coastal Area Management Act (CAMA): All pipes/culverts must be sufficiently sized to allow for the burial of the bottom of the pipe/culvert at least one foot below normal bed elevation when they are placed within the Public Trust Area of Environmental Concern (AEC) and/or the Estuarine Waters AEC as designated by CAMA, and/or all streams appearing as blue lines on United States Geological Survey (USGS) 7.5-minute quadrangle maps.

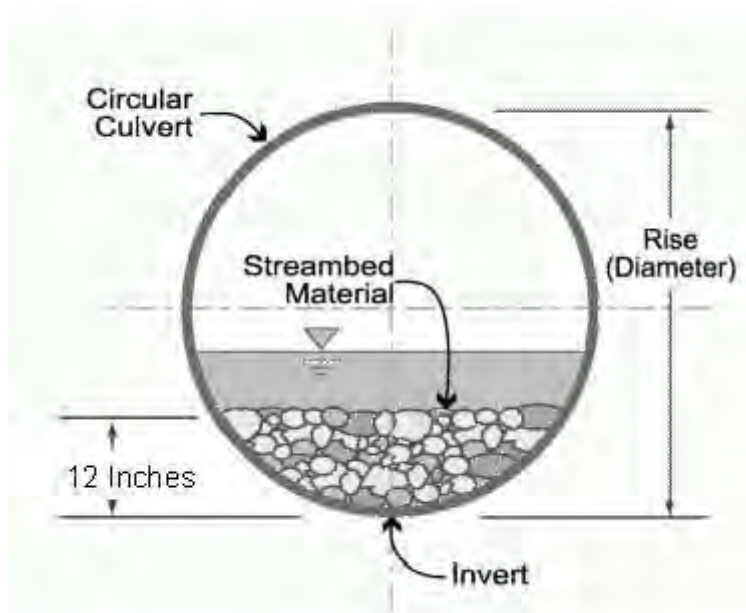

In all other counties: Culverts greater than 48 inches in diameter will be buried at least one foot below the bed of the stream. Culverts 48 inches in diameter or less shall be buried or placed on the stream bed as practicable and appropriate to maintain aquatic passage, and every effort shall be made to maintain the existing channel slope. The bottom of the culvert must be placed at a

depth below the natural stream bottom to provide for passage during drought or low flow conditions.

Culverts are to be designed and constructed in a manner that minimizes destabilization and head cutting. Destabilizing the channel and head cutting upstream should be considered and appropriate actions incorporated in the design and placement of the culvert.

A waiver from the depth specifications in this condition may be requested in writing. The waiver will be issued if it can be demonstrated that the proposal would result in the least impacts to the aquatic environment.

All counties: Culverts placed within riparian and/or riverine wetlands must be installed in a manner that does not restrict the flow and circulation patterns of waters of the United States. Culverts placed across wetland fills purely for the purposes of equalizing surface water do not have to be buried.

### **3.7 Notification to NCDENR Shellfish Sanitation Section**

Applicants shall notify the NCDENR Shellfish Sanitation Section prior to dredging in or removing sediment from an area closed to shell fishing where the effluent may be released to an area open for shell fishing or swimming in order to avoid contamination from the disposal area and cause a temporary shellfish closure to be made. Such notification shall also be provided to the appropriate Corps of Engineers Regulatory Field Office. Any disposal of sand to the ocean beach should occur between November 1 and April 30 when recreational usage is low. Only clean sand should be used and no dredged sand from closed shell fishing areas may be used. If beach disposal were to occur at times other than stated above or if sand from a closed shell fishing area is to be used, a swimming advisory shall be posted, and a press release shall be issued by the permittee.

### **3.8 Preservation of Submerged Aquatic Vegetation**

Adverse impacts to Submerged Aquatic Vegetation (SAV) are not authorized by any NWP within any of the twenty coastal counties defined by North Carolina's Coastal Area Management Act of 1974 (CAMA).

### **3.9 Sedimentation and Erosion Control Structures and Measures**

**3.9.1.** All PCNs will identify and describe sedimentation and erosion control structures and measures proposed for placement in waters of the US. The structures and measures should be depicted on maps, surveys or drawings showing location and impacts to jurisdictional wetlands and streams.

## **4.0 NWP # 13 – Bank Stabilization**

**4.0.1.** Unanchored trees, treetops, or debris may not be used as stream bank stabilization material.

**4.0.2.** Properly anchored and cabled structural stabilization techniques, such as timber crib structures, revetments, and root wads, are acceptable materials to stabilize stream banks.

**4.0.3.** If riprap stabilization is needed, it should be placed only on the stream banks, or, if it is necessary to be placed in the stream bed, the finished top elevation of the riprap should not exceed that of the original stream bed.

## **4.1 NWP #23 – Approved Categorical Exclusions**

No development activities authorized by this NWP may begin until the permittee obtains a consistency concurrence or a CAMA permit from the North Carolina Division of Coastal Management, if either is required.

## **4.2 NWP #33 – Temporary Construction, Access and Dewatering**

The required restoration plan must include a timetable for restoration activities.



North Carolina Department of Environment and Natural Resources

Pat McCrory  
Governor

Donald R. van der Vaart  
Secretary

**RECEIVED**

SEP 08 2015

NCDOT DIVISION 10 OFFICE

September 2, 2015  
Union County  
NCDWR Project No. 15-0719 v.1  
(Bridge 258 on) SR1008  
TIP/State Project No. B-5243

**APPROVAL of 401 WATER QUALITY CERTIFICATION with ADDITIONAL CONDITIONS**

Mr. Louis Mitchell, P.E., Division Engineer  
NCDOT, Division 10  
716 W. Main Street  
Albemarle, NC 28001

Dear Mr. Mitchell:

You have our approval, in accordance with the conditions listed below, for the following impacts at the subject site located at Indian Trail Road in Union County:

**Stream Impacts in the Yadkin River Basin**

Site	Permanent Fill in Intermittent Stream (linear ft)	Temporary Fill in Intermittent Stream (linear ft)	Permanent Fill in Perennial Stream (linear ft)	Temporary Fill in Perennial Stream (linear ft)	Total Stream Impact (linear ft)	Stream Impacts Requiring Mitigation (linear ft)
1 (UT to SF Crooked)	46	36			82	46
2 (UT to SF Crooked)	108	11			119	108
3 (S.Fork Crooked Creek)			154	8	162	154
					0	0
<b>TOTAL</b>	<b>154</b>	<b>47</b>	<b>154</b>	<b>8</b>	<b>363</b>	<b>308</b>

Total Stream Impact for Project: 363 linear feet.

**Wetland Impacts in the Yadkin River Basin (riverine swamp forest/non-tidal freshwater marsh)**

Site	Fill (ac)	Fill (temporary) (ac)	Excavation (ac)	Mechanized Clearing (ac)	Hand Clearing (ac)	Total Wetland Impact (ac)	Impacts Requiring Mitigation (ac)
1	0.02			0.02		0.04	0.04
2	0.03					0.03	0.03
						0.00	0.00
						0.00	0.00
<b>Total</b>	<b>0.05</b>	<b>0.00</b>	<b>0.00</b>	<b>0.02</b>	<b>0.00</b>	<b>0.07</b>	<b>0.07</b>

Total Wetland Impact for Project: 0.07 acres.



The project shall be constructed in accordance with your application dated received July 21, 2015. After reviewing your application, we have decided that these impacts are covered by General Water Quality Certification Numbers 3885, 3891, and 3893. These certifications correspond to the Nationwide Permits 13, 23, and 33 issued by the Corps of Engineers. In addition, you should acquire any other federal, state or local permits before you proceed with your project including (but not limited to) Sediment and Erosion Control, Non-Discharge and Water Supply Watershed regulations. This approval will expire with the accompanying 404 permit.

This approval is valid solely for the purpose and design described in your application (unless modified below). Should your project change, you must notify the NCDWR and submit a new application. If the property is sold, the new owner must be given a copy of this Certification and approval letter, and is thereby responsible for complying with all the conditions. If total wetland fills for this project (now or in the future) exceed one acre, or of total impacts to streams (now or in the future) exceed 150 linear feet, compensatory mitigation may be required as described in 15A NCAC 2H .0506 (h) (6) and (7). For this approval to remain valid, you must adhere to the conditions listed in the attached certification(s) and any additional conditions listed below.

## Condition(s) of Certification:

### Project Specific Conditions

1. Native material shall be placed inside of the reinforced concrete box culvert at Permit Site 1 to create a natural streambed within the low flow barrel(s) of the culvert that matches the upstream and downstream profile and dimensions. If possible, the material placed inside of the culvert should be the same native material that is excavated from the streambed during the construction of the structure. Rip rap may be used only in the floodplain barrel(s) however native material must be placed on top of the rip rap to provide a flat surface for animal passage. [15A NCAC 02H.0506(b)(2)]

### General Conditions

1. Unless otherwise approved in this certification, placement of culverts and other structures in open waters and streams shall be placed below the elevation of the streambed by one foot for all culverts with a diameter greater than 48 inches, and 20 percent of the culvert diameter for culverts having a diameter less than 48 inches, to allow low flow passage of water and aquatic life. Design and placement of culverts and other structures including temporary erosion control measures shall not be conducted in a manner that may result in dis-equilibrium of wetlands or streambeds or banks, adjacent to or upstream and downstream of the above structures. The applicant is required to provide evidence that the equilibrium is being maintained if requested in writing by NCDWR. If this condition is unable to be met due to bedrock or other limiting features encountered during construction, please contact NCDWR for guidance on how to proceed and to determine whether or not a permit modification will be required. [15A NCAC 02H.0506(b)(2)]
2. If concrete is used during construction, a dry work area shall be maintained to prevent direct contact between curing concrete and stream water. Water that inadvertently contacts uncured concrete shall not be discharged to surface waters due to the potential for elevated pH and possible aquatic life and fish kills. [15A NCAC 02B.0200]
3. During the construction of the project, no staging of equipment of any kind is permitted in waters of the U.S., or protected riparian buffers. [15A NCAC 02H.0506(b)(2)]
4. The dimension, pattern and profile of the stream above and below the crossing shall not be modified. Disturbed floodplains and streams shall be restored to natural geomorphic conditions. [15A NCAC 02H.0506(b)(2)]
5. The use of rip-rap above the Normal High Water Mark shall be minimized. Any rip-rap placed for stream stabilization shall be placed in stream channels in such a manner that it does not impede aquatic life passage. [15A NCAC 02H.0506(b)(2)]
6. The Permittee shall ensure that the final design drawings adhere to the permit and to the permit drawings submitted for approval. [15A NCAC 02H .0507(c) and 15A NCAC 02H .0506 (b)(2) and (c)(2)]



## P-36

7. All work in or adjacent to stream waters shall be conducted in a dry work area. Approved BMP measures from the most current version of NCDOT Construction and Maintenance Activities manual such as sandbags, rock berms, cofferdams and other diversion structures shall be used to prevent excavation in flowing water. [15A NCAC 02H.0506(b)(3) and (c)(3)]
8. Heavy equipment shall be operated from the banks rather than in the stream channel in order to minimize sedimentation and reduce the introduction of other pollutants into the stream. [15A NCAC 02H.0506(b)(3)]
9. All mechanized equipment operated near surface waters must be regularly inspected and maintained to prevent contamination of stream waters from fuels, lubricants, hydraulic fluids, or other toxic materials. [15A NCAC 02H.0506(b)(3)]
10. No rock, sand or other materials shall be dredged from the stream channel except where authorized by this certification. [15A NCAC 02H.0506(b)(3)]
11. Discharging hydroseed mixtures and washing out hydroseeders and other equipment in or adjacent to surface waters is prohibited. [15A NCAC 02H.0506(b)(3)]
12. The permittee and its authorized agents shall conduct its activities in a manner consistent with State water quality standards (including any requirements resulting from compliance with §303(d) of the Clean Water Act) and any other appropriate requirements of State and Federal law. If the NCDWR determines that such standards or laws are not being met (including the failure to sustain a designated or achieved use) or that State or federal law is being violated, or that further conditions are necessary to assure compliance, the NCDWR may reevaluate and modify this certification. [15A NCAC 02B.0200]
13. All fill slopes located in jurisdictional wetlands shall be placed at slopes no flatter than 3:1, unless otherwise authorized by this certification. [15A NCAC 02H.0506(b)(2)]
14. A copy of this Water Quality Certification shall be maintained on the construction site at all times. In addition, the Water Quality Certification and all subsequent modifications, if any, shall be maintained with the Division Engineer and the on-site project manager. [15A NCAC 02H .0507(c) and 15A NCAC 02H .0506 (b)(2) and (c)(2)]
15. The outside buffer, wetland or water boundary located within the construction corridor approved by this authorization shall be clearly marked by highly visible fencing prior to any land disturbing activities. Impacts to areas within the fencing are prohibited unless otherwise authorized by this certification. [15A NCAC 02H.0501 and .0502]
16. The issuance of this certification does not exempt the Permittee from complying with any and all statutes, rules, regulations, or ordinances that may be imposed by other government agencies (i.e. local, state, and federal) having jurisdiction, including but not limited to applicable buffer rules, stormwater management rules, soil erosion and sedimentation control requirements, etc.
17. The Permittee shall report any violations of this certification to the Division of Water Resources within 24 hours of discovery. [15A NCAC 02B.0506(b)(2)]
18. Upon completion of the project (including any impacts at associated borrow or waste sites), the NCDOT Division Engineer shall complete and return the enclosed "Certification of Completion Form" to notify the NCDWR when all work included in the 401 Certification has been completed. [15A NCAC 02H.0502(f)]
19. Native riparian vegetation (ex. *Salix nigra*, *Juncus (spp)* , *Carex (spp)*, et al.) must be reestablished in the riparian areas within the construction limits of the project by the end of the growing season following completion of construction.[15A NCAC 02H.00506(b)(2)]
20. There shall be no excavation from, or waste disposal into, jurisdictional wetlands or waters associated with this permit without appropriate modification. Should waste or borrow sites, or access roads to waste or borrow sites, be located in wetlands or streams, compensatory mitigation will be required since that is a direct impact from road construction activities.[15A NCAC 02H.0506(b)(3) and (c)(3)]



21. Erosion and sediment control practices must be in full compliance with all specifications governing the proper design, installation and operation and maintenance of such Best Management Practices in order to protect surface waters standards [15A NCAC 02H.0506(b)(3) and (c)(3)]:
  - a. The erosion and sediment control measures for the project must be designed, installed, operated, and maintained in accordance with the most recent version of the *North Carolina Sediment and Erosion Control Planning and Design Manual*.
  - b. The design, installation, operation, and maintenance of the sediment and erosion control measures must be such that they equal, or exceed, the requirements specified in the most recent version of the *North Carolina Sediment and Erosion Control Manual*. The devices shall be maintained on all construction sites, borrow sites, and waste pile (spoil) projects, including contractor-owned or leased borrow pits associated with the project.
  - c. For borrow pit sites, the erosion and sediment control measures must be designed, installed, operated, and maintained in accordance with the most recent version of the *North Carolina Surface Mining Manual*.
  - d. The reclamation measures and implementation must comply with the reclamation in accordance with the requirements of the Sedimentation Pollution Control Act.
  
22. Sediment and erosion control measures shall not be placed in wetlands or waters unless otherwise approved by this Certification. [15A NCAC 02H.0506(b)(3) and (c)(3)]

If you wish to contest any statement in the attached Certification you must file a petition for an administrative hearing. You may obtain the petition form from the office of Administrative hearings. You must file the petition with the office of Administrative Hearings within sixty (60) days of receipt of this notice. A petition is considered filed when it is received in the office of Administrative Hearings during normal office hours. The Office of Administrative Hearings accepts filings Monday through Friday between the hours of 8:00am and 5:00pm, except for official state holidays. The original and one (1) copy of the petition must be filed with the Office of Administrative Hearings.

The petition may be faxed-provided the original and one copy of the document is received by the Office of Administrative Hearings within five (5) business days following the faxed transmission. The mailing address for the Office of Administrative Hearings is:

Office of Administrative Hearings  
6714 Mail Service Center  
Raleigh, NC 27699-6714  
Telephone: (919) 431-3000, Facsimile: (919) 431-3100

A copy of the petition must also be served on DENR as follows:

Mr. Sam M.Hayes, General Counsel  
Department of Environment and Natural Resources  
1601 Mail Service Center

This letter completes the review of the Division of Water Resources under Section 401 of the Clean Water Act. If you have any questions, please contact Donna Hood, Environmental Senior Specialist at (704)235-2193 or [donna.hood@ncdenr.gov](mailto:donna.hood@ncdenr.gov).

Sincerely,

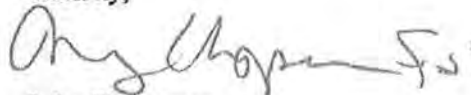

S. Jay Zimmerman  
Director, Division of Water Resources

Electronic copy only distribution:

Ms. Crystal Amschler, US Army Corps of Engineers, Asheville Field Office  
Mr. Larry Thompson, Division 10 Environmental Officer  
Ms. Marella Bunkirk, US Fish and Wildlife Service  
Ms. Marla Chambers, NC Wildlife Resources Commission  
Beth Harmon, Division of Mitigation Services NC Division of Water Resources Raleigh Central Office



**P-38**  
Water Quality Certification No. 3885

**GENERAL CERTIFICATION FOR STREAM RESTORATION, ENHANCEMENT AND STABILIZATION PROJECTS AND WETLAND AND RIPARIAN RESTORATION AND CREATION ACTIVITIES INCLUDING THOSE ELIGIBLE FOR U.S. ARMY CORPS OF ENGINEERS NATIONWIDE PERMIT NUMBERS 13 (BANK STABILIZATION) AND 27 (WETLAND AND RIPARIAN RESTORATION AND CREATION), AND REGIONAL PERMIT 197800080 (BULKHEADS AND RIPRAP) AND RIPARIAN AREA PROTECTION RULES (BUFFER RULES)**

Water Quality Certification Number 3885 is issued in conformity with the requirements of Section 401, Public Laws 92-500 and 95-217 of the United States and subject to the North Carolina Division of Water Quality Regulations in 15A NCAC 02H .0500 and 15A NCAC 02B .0200 for the discharge of fill material to waters as described in 33 CFR 330 Appendix A (B) (13 and 27) and Regional Permit 197800080 and for the Riparian Area Protection Rules (Buffer Rules) in 15A NCAC 02B .0200.

**The State of North Carolina certifies that the specified category of activity will not violate applicable portions of Sections 301, 302, 303, 306 and 307 of the Public Laws 92-500 and 95-217 if conducted in accordance with the conditions hereinafter set forth.**

**Activities meeting any one (1) of the following thresholds or circumstances require *written approval* for a 401 Water Quality Certification from the Division of Water Quality (the "Division"):**

- \* a) All proposed fill or modification of wetlands and/or waters, including streams and streambanks, regardless of the purpose of the restoration, enhancement, stabilization, or creation activity, except for single and independent projects involving in-stream structures for the sole purpose of streambank stabilization, which are designed based on current natural channel techniques, and do not exceed a total of three structures within 100 feet or less of streambank; or
  - b) Any stream relocation; or
  - c) Bank Stabilization projects qualifying for Nationwide Permit 13 for erosion protection which utilize non-natural armoring such as riprap, gabion baskets, deflection walls etc of greater than 150 feet in streambank length; or
  - d) Bank Stabilization projects qualifying for Nationwide Permit 13 for erosion protection which utilize natural streambank sloping, vegetation, and other natural channel protection techniques of greater than 500 feet of streambank length; or
  - e) Any impact associated with a Notice of Violation or an enforcement action for violation(s) of DWQ Wetland Rules (15A NCAC 02H .0500), Isolated Wetland Rules (15A NCAC 02H .1300), DWQ Surface Water or Wetland Standards, or Riparian Buffer Rules (15A NCAC 02B .0200); or
  - \* f) Any impacts to streams and/or buffers in the Neuse, Tar-Pamlico, or Catawba River Basins or in the Randleman, Jordan or Goose Creek Watersheds (or any other basin or watershed with Riparian Area Protection Rules [Buffer Rules] in effect at the time of application) *unless* the activities are listed as "EXEMPT" from these rules or a Buffer Authorization Certificate is issued through N.C. Division of Coastal Management (DCM) delegation for "ALLOWABLE" activities.
- \* In accordance with North Carolina General Statute 143-215.3D(e), written approval for a 401 Water Quality General Certification must include the appropriate fee. If a project also requires a CAMA Permit, then one payment to both agencies shall be submitted and will be the higher of the two fees.

**P-39**  
Water Quality Certification No. 3885

**Activities included in this General Certification that do not meet one of the thresholds listed above do not require written approval from the Division as long as they comply with the Conditions of Certification listed below. If any of these Conditions cannot be met, then written approval from the Division is required.**

Conditions of Certification:

1. Activities shall meet the definitions, design, and monitoring protocols specified within the US Army Corps of Engineers Wilmington District *Regulatory Guidance Letter* (RGL02-02) and the *Stream Mitigation Guidelines* (April 2003) or any subsequent updates to these documents.
2. No Impacts Beyond those Authorized in the Written Approval or Beyond the Threshold of Use of this Certification

No waste, spoil, solids, or fill of any kind shall occur in wetlands, waters, or riparian areas beyond the footprint of the impacts depicted in the Pre-Construction Notification, as authorized in the written approval from the Division or beyond the thresholds established for use of this Certification without written authorization, including incidental impacts. All construction activities, including the design, installation, operation, and maintenance of sediment and erosion control Best Management Practices shall be performed so that no violations of state water quality standards, statutes, or rules occur. Approved plans and specifications for this project are incorporated by reference and are enforceable parts of this permit.

3. Standard Erosion and Sediment Control Practices

Erosion and sediment control practices must be in full compliance with all specifications governing the proper design, installation and operation and maintenance of such Best Management Practices and if applicable, comply with the specific conditions and requirements of the NPDES Construction Stormwater Permit issued to the site:

- a. Design, installation, operation, and maintenance of the sediment and erosion control measures must be such that they equal or exceed the requirements specified in the most recent version of the *North Carolina Sediment and Erosion Control Manual*. The devices shall be maintained on all construction sites, borrow sites, and waste pile (spoil) projects, including contractor-owned or leased borrow pits associated with the project.
- b. For borrow pit sites, the erosion and sediment control measures must be designed, installed, operated, and maintained in accordance with the most recent version of the *North Carolina Surface Mining Manual*.
- c. Reclamation measures and implementation must comply with the reclamation in accordance with the requirements of the Sedimentation Pollution Control Act and the Mining Act of 1971.
- d. Sufficient materials required for stabilization and/or repair of erosion control measures and stormwater routing and treatment shall be on site at all times.
- e. If the project occurs in waters or watersheds classified as Primary Nursery Areas (PNAs), SA, WS-I, WS-II, High Quality (HQW), or Outstanding Resource (ORW) waters, then the sedimentation and erosion control designs must comply with the requirements set forth in 15A NCAC 04B .0124, *Design Standards in Sensitive Watersheds*.



**P-40**  
**Water Quality Certification No. 3885**

4. No Sediment and Erosion Control Measures in Wetlands or Waters

Sediment and erosion control measures shall not be placed in wetlands or waters. Exceptions to this condition require application submittal to and written approval by the Division. If placement of sediment and erosion control devices in wetlands and waters is unavoidable, then design and placement of temporary erosion control measures shall not be conducted in a manner that may result in dis-equilibrium of wetlands, stream beds, or banks, adjacent to or upstream and downstream of the above structures. All sediment and erosion control devices shall be removed and the natural grade restored within two (2) months of the date that the Division of Land Resources (DLR) or locally delegated program has released the specific area within the project.

5. Construction Stormwater Permit NCG010000

An NPDES Construction Stormwater Permit is required for construction projects that disturb one (1) or more acres of land. This Permit allows stormwater to be discharged during land disturbing construction activities as stipulated in the conditions of the permit. If your project is covered by this permit, full compliance with permit conditions including the erosion & sedimentation control plan, inspections and maintenance, self-monitoring, record keeping and reporting requirements is required. A copy of the general permit (NCG010000), inspection log sheets, and other information may be found at <http://portal.ncdenr.org/web/wq/ws/su/npdessw#tab-w>.

The North Carolina Department of Transportation (NCDOT) shall be required to be in full compliance with the conditions related to construction activities within the most recent version of their individual NPDES (NCS000250) stormwater permit.

6. Construction Moratoriums and Coordination

If activities must occur during periods of high biological activity (i.e. sea turtle nesting, fish spawning, or bird nesting), then biological monitoring may be required at the request of other state or federal agencies and coordinated with these activities.

All moratoriums on construction activities established by the NC Wildlife Resources Commission (WRC), US Fish and Wildlife Service (USFWS), NC Division of Marine Fisheries (DMF), or National Marine Fisheries Service (NMFS) to lessen impacts on trout, anadromous fish, larval/post-larval fishes and crustaceans, or other aquatic species of concern shall be implemented. Exceptions to this condition require written approval by the resource agency responsible for the given moratorium.

Work within the twenty-five (25) designated trout counties or identified state or federal endangered or threatened species habitat shall be coordinated with the appropriate WRC, USFWS, NMFS, and/or DMF personnel.

7. Work in the Dry

All work in or adjacent to stream waters shall be conducted so that the flowing stream does not come in contact with the disturbed area. Approved best management practices from the most current version of the NC Sediment and Erosion Control Manual, or the NC DOT Construction and Maintenance Activities Manual, such as sandbags, rock berms, cofferdams, and other diversion structures shall be used to minimize excavation in flowing water. Exceptions to this condition require application submittal to and written approval by the Division.



**P-41**  
**Water Quality Certification No. 3885**

8. Riparian Area Protection (Buffer) Rules

Activities located in the protected riparian areas (whether jurisdictional wetlands or not), within the Neuse, Tar-Pamlico, or Catawba River Basins or in the Randleman, Jordan, or Goose Creek Watersheds (or any other basin or watershed with buffer rules) shall be limited to "uses" identified within and constructed in accordance with 15A NCAC 02B .0233, .0259, .0243, .0250, .0267 and .0605, and shall be located, designed, constructed, and maintained to have minimal disturbance to protect water quality to the maximum extent practicable through the use of best management practices. All buffer rule requirements, including diffuse flow requirements, must be met.

9. If concrete is used during the construction, then all necessary measures shall be taken to prevent direct contact between uncured or curing concrete and waters of the state. Water that inadvertently contacts uncured concrete shall not be discharged to waters of the state due to the potential for elevated pH and possible aquatic life/ fish kills.
10. All temporary fill and culverts shall be removed and the impacted area returned to natural conditions within 60 days of the determination that the temporary impact is no longer necessary. The impacted areas shall be restored to original grade, including each stream's original cross sectional dimensions, plan form pattern, and longitudinal bed and bed profile, and the various sites shall be stabilized with natural woody vegetation (except for the approved maintenance areas) and restored to prevent erosion.
11. All temporary pipes/ culverts/ riprap pads etc, shall be installed in all streams as outlined in the most recent edition of the *North Carolina Sediment and Erosion Control Planning and Design Manual* or the *North Carolina Surface Mining Manual* so as not to restrict stream flow or cause dis-equilibrium during use of this General Certification.
12. Any riprap required for proper culvert placement, stream stabilization, or restoration of temporarily disturbed areas shall be restricted to the area directly impacted by the approved construction activity. All rip-rap shall be buried and/or "keyed in" such that the original stream elevation and streambank contours are restored and maintained. Placement of rip-rap or other approved materials shall not result in de-stabilization of the stream bed or banks upstream or downstream of the area.
13. Any rip-rap used for stream stabilization shall be of a size and density so as not to be able to be carried off by wave, current action, or stream flows and consist of clean rock or masonry material free of debris or toxic pollutants. Rip-rap shall not be installed in the streambed except in specific areas required for velocity control and to ensure structural integrity of bank stabilization measures.
14. A one-time application of fertilizer to re-establish vegetation is allowed in disturbed areas including riparian buffers, but is restricted to no closer than 10 feet from top of bank of streams. Any fertilizer application must comply with all other Federal, State and Local regulations.
15. Applications for riprap groins proposed in accordance with 15A NCAC 07H .1401 (NC Division of Coastal Management General Permit for construction of Wooden and Riprap Groins in Estuarine and Public Trust Waters) must meet all the specific conditions for design and construction specified in 15A NCAC 07H .1405.



**P-42**  
**Water Quality Certification No. 3885**

\* 16. Compensatory Mitigation

In accordance with 15A NCAC 02H .0506 (h), compensatory mitigation may be required for losses of equal to or greater than 150 linear feet of streams (intermittent and perennial) and/or equal to or greater than one (1) acre of wetlands. For linear public transportation projects, impacts equal to or exceeding 150 linear feet per stream shall require mitigation

Buffer mitigation may be required for any project with Buffer Rules in effect at the time of application for activities classified as "Allowable with Mitigation" or "Prohibited" within the Table of Uses.

A determination of buffer, wetland, and stream mitigation requirements shall be made for any General Water Quality Certification for this Nationwide and/or Regional General Permit. Design and monitoring protocols shall follow the US Army Corps of Engineers Wilmington District *Stream Mitigation Guidelines* (April 2003) or its subsequent updates. Compensatory mitigation plans shall be submitted to the Division for written approval as required in those protocols. The mitigation plan must be implemented and/or constructed before any impacts occur on site. Alternatively, the Division will accept payment into an in-lieu fee program or a mitigation bank. In these cases, proof of payment shall be provided to the Division before any impacts occur on site.

- \* 17. If an environmental document is required under the National or State Environmental Policy Act (NEPA or SEPA), then this General Certification is not valid until a Finding of No Significant Impact (FONSI) or Record of Decision (ROD) is issued by the State Clearinghouse.
18. In the twenty (20) coastal counties, the appropriate DWQ Regional Office must be contacted to determine if Coastal Stormwater Regulations will be required.
19. This General Certification does not relieve the applicant of the responsibility to obtain all other required Federal, State, or Local approvals.
20. The applicant/permittee and their authorized agents shall conduct all activities in a manner consistent with State water quality standards (including any requirements resulting from compliance with §303(d) of the Clean Water Act), and any other appropriate requirements of State and Federal Law. If the Division determines that such standards or laws are not being met, including failure to sustain a designated or achieved use, or that State or Federal law is being violated, or that further conditions are necessary to assure compliance, then the Division may reevaluate and modify this General Water Quality Certification.
- \* 21. When written authorization is required for use of this certification, upon completion of all permitted impacts included within the approval and any subsequent modifications, the applicant shall be required to return the certificate of completion attached to the approval. One copy of the certificate shall be sent to the DWQ Central Office in Raleigh at 1650 Mail Service Center, Raleigh, NC, 27699-1650.
22. Additional site-specific conditions, including monitoring and/or modeling requirements, may be added to the written approval letter for projects proposed under this Water Quality Certification in order to ensure compliance with all applicable water quality and effluent standards.
23. This certification grants permission to the director, an authorized representative of the Director, or DENR staff, upon the presentation of proper credentials, to enter the property during normal business hours.

**P-43**  
**Water Quality Certification No. 3885**

This General Certification shall expire on the same day as the expiration date of the corresponding Nationwide and/or Regional General Permit. The conditions in effect on the date of issuance of Certification for a specific project shall remain in effect for the life of the project, regardless of the expiration date of this Certification.

Non-compliance with or violation of the conditions herein set forth by a specific project may result in revocation of this General Certification for the project and may also result in criminal and/or civil penalties.

The Director of the North Carolina Division of Water Quality may require submission of a formal application for Individual Certification for any project in this category of activity if it is determined that the project is likely to have a significant adverse effect upon water quality, including state or federally listed endangered or threatened aquatic species, or degrade the waters so that existing uses of the wetland or downstream waters are precluded.

Public hearings may be held for specific applications or group of applications prior to a Certification decision if deemed in the public's best interest by the Director of the North Carolina Division of Water Quality.

Effective date: March 19, 2012

DIVISION OF WATER QUALITY

By



Charles Wakild, P.E.

Director

*History Note: Water Quality Certification (WQC) Number 3885 issued March 19, 2012 replaces WQC Number 3689 issued November 1, 2007; WQC Number 3626 issued March, 2007; WQC Number 3495 issued December 31, 2004; and WQC Number 3399 issued March 2003. This General Certification is rescinded when the Corps of Engineers reauthorizes any of the corresponding Nationwide and/or Regional General Permits and/or when deemed appropriate by the Director of the Division of Water Quality.*



# P-44

## Water Quality Certification No. 3891

### GENERAL CERTIFICATION FOR PROJECTS ELIGIBLE FOR U.S. ARMY CORPS OF ENGINEERS NATIONWIDE PERMIT NUMBER 23 (APPROVED CATEGORICAL EXCLUSIONS) AND RIPARIAN AREA PROTECTION RULES (BUFFER RULES)

Water Quality Certification Number 3891 is issued in conformity with the requirements of Section 401, Public Laws 92-500 and 95-217 of the United States and subject to the North Carolina Division of Water Quality Regulations in 15A NCAC 02H .0500 and 15A NCAC 02B .0200 for the discharge of fill material to waters and wetland areas as described in 33 CFR 330 Appendix A (B) (23) and for the Riparian Area Protection Rules (Buffer Rules) in 15A NCAC 02B .0200.

The category of activities shall include only Federally-approved Categorical Exclusion projects.

The State of North Carolina certifies that the specified category of activity will not violate applicable portions of Sections 301, 302, 303, 306 and 307 of the Public Laws 92-500 and 95-217 if conducted in accordance with the conditions hereinafter set forth.

**Activities meeting any one (1) of the following thresholds or circumstances require written approval for a 401 Water Quality Certification from the Division of Water Quality (the "Division"):**

- a) Stream impacts (temporary or permanent) equal or greater than 40 linear feet; or
  - b) Any stream relocation; or
  - c) Impacts equal to or greater than one-tenth (1/10) acre of wetlands or open waters; or
  - d) Any impacts to wetlands adjacent to waters designated as: ORW, SA, WS-I, WS-II, or Trout, or wetlands contiguous to waters designated as a North Carolina or National Wild and Scenic River.
  - e) Any impacts to coastal wetlands [15A NCAC 7H .0205)], or Unique Wetlands (UWL) [15A NCAC 2H .0506].
  - f) Any impact associated with a Notice of Violation or an enforcement action for violation(s) of DWQ Wetland Rules (15A NCAC 02H .0500), Isolated Wetland Rules (15A NCAC 02H .1300), DWQ Surface Water or Wetland Standards, or Riparian Buffer Rules (15A NCAC 02B .0200); or
  - \* g) Any impacts to streams and/or buffers in the Neuse, Tar-Pamlico, or Catawba River Basins or in the Randleman, Jordan or Goose Creek Watersheds (or any other basin or watershed with Riparian Area Protection Rules [Buffer Rules] in effect at the time of application) *unless* the activities are listed as "EXEMPT" from these rules or a Buffer Authorization Certificate is issued through N.C. Division of Coastal Management (DCM) delegation for "ALLOWABLE" activities.
- \* In accordance with North Carolina General Statute 143-215.3D(e), written approval for a 401 Water Quality General Certification must include the appropriate fee. If a project also requires a CAMA Permit, then one payment to both agencies shall be submitted and will be the higher of the two fees.

**Activities included in this General Certification that do not meet one of the thresholds listed above do not require written approval from the Division as long as they comply with the Conditions of Certification listed below. If any of these Conditions cannot be met, then written approval from the Division is required.**

Conditions of Certification:

1. No Impacts Beyond those Authorized in the Written Approval or Beyond the Threshold of Use of this Certification

No waste, spoil, solids, or fill of any kind shall occur in wetlands, waters, or riparian areas beyond the footprint of the impacts depicted in the Pre-Construction Notification, as

# P-45

## Water Quality Certification No. 3891

authorized in the written approval from the Division or beyond the thresholds established for use of this Certification without written authorization, including incidental impacts. All construction activities, including the design, installation, operation, and maintenance of sediment and erosion control Best Management Practices shall be performed so that no violations of state water quality standards, statutes, or rules occur. Approved plans and specifications for this project are incorporated by reference and are enforceable parts of this permit.

### 2. Standard Erosion and Sediment Control Practices

Erosion and sediment control practices must be in full compliance with all specifications governing the proper design, installation and operation and maintenance of such Best Management Practices and if applicable, comply with the specific conditions and requirements of the NPDES Construction Stormwater Permit issued to the site:

- a. Design, installation, operation, and maintenance of the sediment and erosion control measures must be such that they equal or exceed the requirements specified in the most recent version of the *North Carolina Sediment and Erosion Control Manual*. The devices shall be maintained on all construction sites, borrow sites, and waste pile (spoil) projects, including contractor-owned or leased borrow pits associated with the project.
- b. For borrow pit sites, the erosion and sediment control measures must be designed, installed, operated, and maintained in accordance with the most recent version of the *North Carolina Surface Mining Manual*.
- c. Reclamation measures and implementation must comply with the reclamation in accordance with the requirements of the Sedimentation Pollution Control Act and the Mining Act of 1971.
- d. Sufficient materials required for stabilization and/or repair of erosion control measures and stormwater routing and treatment shall be on site at all times.
- e. If the project occurs in waters or watersheds classified as Primary Nursery Areas (PNAs), SA, WS-I, WS-II, High Quality (HQW), or Outstanding Resource (ORW) waters, then the sedimentation and erosion control designs must comply with the requirements set forth in 15A NCAC 04B .0124, *Design Standards in Sensitive Watersheds*.

### 3. No Sediment and Erosion Control Measures in Wetlands or Waters

Sediment and erosion control measures shall not be placed in wetlands or waters. Exceptions to this condition require application submittal to and written approval by the Division. If placement of sediment and erosion control devices in wetlands and waters is unavoidable, then design and placement of temporary erosion control measures shall not be conducted in a manner that may result in dis-equilibrium of wetlands, stream beds, or banks, adjacent to or upstream and downstream of the above structures. All sediment and erosion control devices shall be removed and the natural grade restored within two (2) months of the date that the Division of Land Resources (DLR) or locally delegated program has released the specific area within the project.

### 4. Construction Stormwater Permit NCG010000



# P-46

## Water Quality Certification No. 3891

An NPDES Construction Stormwater Permit is required for construction projects that disturb one (1) or more acres of land. This Permit allows stormwater to be discharged during land disturbing construction activities as stipulated in the conditions of the permit. If your project is covered by this permit, full compliance with permit conditions including the erosion & sedimentation control plan, inspections and maintenance, self-monitoring, record keeping and reporting requirements is required. A copy of the general permit (NCG010000), inspection log sheets, and other information may be found at <http://portal.ncdenr.org/web/wq/ws/su/npdessw#tab-w>.

The North Carolina Department of Transportation (NCDOT) shall be required to be in full compliance with the conditions related to construction activities within the most recent version of their individual NPDES (NCS000250) stormwater permit.

### 5. Construction Moratoriums and Coordination

If activities must occur during periods of high biological activity (i.e. sea turtle nesting, fish spawning, or bird nesting), then biological monitoring may be required at the request of other state or federal agencies and coordinated with these activities.

All moratoriums on construction activities established by the NC Wildlife Resources Commission (WRC), US Fish and Wildlife Service (USFWS), NC Division of Marine Fisheries (DMF), or National Marine Fisheries Service (NMFS) to lessen impacts on trout, anadromous fish, larval/post-larval fishes and crustaceans, or other aquatic species of concern shall be implemented. Exceptions to this condition require written approval by the resource agency responsible for the given moratorium.

Work within the twenty-five (25) designated trout counties or identified state or federal endangered or threatened species habitat shall be coordinated with the appropriate WRC, USFWS, NMFS, and/or DMF personnel.

### 6. Work in the Dry

All work in or adjacent to stream waters shall be conducted so that the flowing stream does not come in contact with the disturbed area. Approved best management practices from the most current version of the NC Sediment and Erosion Control Manual, or the NC DOT Construction and Maintenance Activities Manual, such as sandbags, rock berms, cofferdams, and other diversion structures shall be used to minimize excavation in flowing water. Exceptions to this condition require application submittal to and written approval by the Division.

### 7. Riparian Area Protection (Buffer) Rules

Activities located in the protected riparian areas (whether jurisdictional wetlands or not), within the Neuse, Tar-Pamlico, or Catawba River Basins or in the Randleman, Jordan, or Goose Creek Watersheds (or any other basin or watershed with buffer rules) shall be limited to "uses" identified within and constructed in accordance with 15A NCAC 02B .0233, .0259, .0243, .0250, .0267 and .0605, and shall be located, designed, constructed, and maintained to have minimal disturbance to protect water quality to the maximum extent practicable through the use of best management practices. All buffer rule requirements, including diffuse flow requirements, must be met.

8. If concrete is used during the construction, then all necessary measures shall be taken to prevent direct contact between uncured or curing concrete and waters of the state. Water that inadvertently contacts uncured concrete shall not be discharged to waters of the state due to the potential for elevated pH and possible aquatic life/ fish kills.

**P-47**  
**Water Quality Certification No. 3891**

9. Bridge deck drains shall not discharge directly into the stream. Stormwater shall be directed across the bridge and pre-treated through site-appropriate means (grassed swales, pre-formed scour holes, vegetated buffers, etc.) before entering the stream. Please refer to the most current version of *Stormwater Best Management Practices*. Exceptions to this condition require written approval by the Division.
10. Relocated stream designs should include the same dimensions, patterns, and profiles as the existing channel (or a stable reference reach if the existing channel is unstable), to the maximum extent practical. The new channel should be constructed in the dry and water shall not be turned into the new channel until the banks are stabilized. Vegetation used for bank stabilization shall be limited to native woody species, and should include establishment of a 30-foot wide wooded and an adjacent 20-foot wide vegetated buffer on both sides of the relocated channel to the maximum extent practical. A transitional phase incorporating appropriate erosion control matting materials and seedling establishment is allowable, however matting that incorporates plastic mesh and/or plastic twine shall not be used in wetlands, riparian buffers or floodplains as recommended by the North Carolina Sediment and Erosion Control Manual. Rip-rap, A-Jacks, concrete, gabions or other hard structures may be allowed if it is necessary to maintain the physical integrity of the stream; however, the applicant must provide written justification and any calculations used to determine the extent of rip-rap coverage. Please note that if the stream relocation is conducted as a stream restoration as defined in the US Army Corps of Engineers Wilmington District, April 2003 *Stream Mitigation Guidelines* (or its subsequent updates), the restored length may be used as compensatory mitigation for the impacts resulting from the relocation.

11. Placement of Culverts and Other Structures in Waters and Wetlands

Culverts required for this project shall be designed and installed in such a manner that the original stream profiles are not altered and allow for aquatic life movement during low flows. Existing stream dimensions (including the cross section dimensions, pattern, and longitudinal profile) must be maintained above and below locations of each culvert.

Placement of culverts and other structures in waters and streams must be below the elevation of the streambed by one foot for all culverts with a diameter greater than 48 inches, and 20 percent of the culvert diameter for culverts having a diameter less than or equal to 48 inches, to allow low flow passage of water and aquatic life.

When topographic constraints indicate culvert slopes of greater than 5%, culvert burial is not required, provided that all alternative options for flattening the slope have been investigated and aquatic life movement/ connectivity has been provided when possible (rock ladders, crossvanes, etc). Notification to the Division including supporting documentation to include a location map of the culvert, culvert profile drawings, and slope calculations shall be provided to the Division 60 days prior to the installation of the culvert.

When bedrock is present in culvert locations, culvert burial is not required provided that there is sufficient documentation of the presence of bedrock. Notification to the Division including supporting documentation such as, but not limited to, a location map of the culvert, geotechnical reports, photographs, etc shall be provided to the Division a minimum of 60 days prior to the installation of the culvert. If bedrock is discovered during construction, then the Division shall be notified by phone or email within 24 hours of discovery.

If other site-specific topographic constraints preclude the ability to bury the culverts as described above and/or it can be demonstrated that burying the culvert would result in destabilization of the channel, then exceptions to this condition require application submittal to, and written approval by, the Division of Water Quality, regardless of the total impacts to streams or wetlands from the project.



# P-48

## Water Quality Certification No. 3891

Installation of culverts in wetlands must ensure continuity of water movement and be designed to adequately accommodate high water or flood conditions. Additionally, when roadways, causeways, or other fill projects are constructed across FEMA-designated floodways or wetlands, openings such as culverts or bridges must be provided to maintain the natural hydrology of the system as well as prevent constriction of the floodway that may result in destabilization of streams or wetlands.

The establishment of native, woody vegetation and other soft stream bank stabilization techniques must be used where practicable instead of riprap or other bank hardening methods.

\* 12. Compensatory Mitigation

In accordance with 15A NCAC 02H .0506 (h), compensatory mitigation may be required for losses of equal to or greater than 150 linear feet of streams (intermittent and perennial) and/or equal to or greater than one (1) acre of wetlands. For linear public transportation projects, impacts equal to or exceeding 150 linear feet per stream shall require mitigation.

Buffer mitigation may be required for any project with Buffer Rules in effect at the time of application for activities classified as "Allowable with Mitigation" or "Prohibited" within the Table of Uses.

A determination of buffer, wetland, and stream mitigation requirements shall be made for any General Water Quality Certification for this Nationwide and/or Regional General Permit. Design and monitoring protocols shall follow the US Army Corps of Engineers Wilmington District *Stream Mitigation Guidelines* (April 2003) or its subsequent updates. Compensatory mitigation plans shall be submitted to the Division for written approval as required in those protocols. The mitigation plan must be implemented and/or constructed before any impacts occur on site. Alternatively, the Division will accept payment into an in-lieu fee program or a mitigation bank. In these cases, proof of payment shall be provided to the Division before any impacts occur on site.

- \* 13. If an environmental document is required under the National or State Environmental Policy Act (NEPA or SEPA), then this General Certification is not valid until a Finding of No Significant Impact (FONSI) or Record of Decision (ROD) is issued by the State Clearinghouse.
14. In the twenty (20) coastal counties, the appropriate DWQ Regional Office must be contacted to determine if Coastal Stormwater Regulations will be required.
15. This General Certification does not relieve the applicant of the responsibility to obtain all other required Federal, State, or Local approvals.
16. The applicant/permittee and their authorized agents shall conduct all activities in a manner consistent with State water quality standards (including any requirements resulting from compliance with §303(d) of the Clean Water Act), and any other appropriate requirements of State and Federal Law. If the Division determines that such standards or laws are not being met, including failure to sustain a designated or achieved use, or that State or Federal law is being violated, or that further conditions are necessary to assure compliance, then the Division may reevaluate and modify this General Water Quality Certification.

**P-49**  
**Water Quality Certification No. 3891**

- \* 17. When written authorization is required for use of this certification, upon completion of all permitted impacts included within the approval and any subsequent modifications, the applicant shall be required to return the certificate of completion attached to the approval. One copy of the certificate shall be sent to the DWQ Central Office in Raleigh at 1650 Mail Service Center, Raleigh, NC, 27699-1650.
- 18. Additional site-specific conditions, including monitoring and/or modeling requirements, may be added to the written approval letter for projects proposed under this Water Quality Certification in order to ensure compliance with all applicable water quality and effluent standards.
- 19. This certification grants permission to the director, an authorized representative of the Director, or DENR staff, upon the presentation of proper credentials, to enter the property during normal business hours.

This General Certification shall expire on the same day as the expiration date of the corresponding Nationwide and/or Regional General Permit. The conditions in effect on the date of issuance of Certification for a specific project shall remain in effect for the life of the project, regardless of the expiration date of this Certification.

Non-compliance with or violation of the conditions herein set forth by a specific project may result in revocation of this General Certification for the project and may also result in criminal and/or civil penalties.

The Director of the North Carolina Division of Water Quality may require submission of a formal application for Individual Certification for any project in this category of activity if it is determined that the project is likely to have a significant adverse effect upon water quality, including state or federally listed endangered or threatened aquatic species, or degrade the waters so that existing uses of the wetland or downstream waters are precluded.

Public hearings may be held for specific applications or group of applications prior to a Certification decision if deemed in the public's best interest by the Director of the North Carolina Division of Water Quality.

Effective date: March 19, 2012

DIVISION OF WATER QUALITY

By



Charles Wakild, P.E.

Director

*History Note: Water Quality Certification (WQC) Number 3891 issued March 19, 2012 replaces WQC 3701 issued November 1, 2007; WQC Number 3632 issued March 2007; WQC Number 3403 issued March 2003; WQC Number 3361 issued March 18, 2002; WQC Number 3107 issued February 11, 1997; WQC Number 2734 issued May 1 1993; and WQC Number 2670 issued on January 21, 1992. This General Certification is rescinded when the Corps of Engineers reauthorizes any of the corresponding Nationwide and/or Regional General Permits or when deemed appropriate by the Director of the Division of Water Quality.*



# P-50

## Water Quality Certification No. 3893

**GENERAL CERTIFICATION FOR PROJECTS ELIGIBLE  
FOR U.S. ARMY CORPS OF ENGINEERS NATIONWIDE PERMIT NUMBER 33  
(TEMPORARY CONSTRUCTION, ACCESS AND DEWATERING)  
AND RIPARIAN AREA PROTECTION RULES (BUFFER RULES)**

Water Quality Certification Number 3893 is issued in conformity with the requirements of Section 401, Public Laws 92-500 and 95-217 of the United States and subject to the North Carolina Division of Water Quality Regulations in 15A NCAC 02H .0500 and 15A NCAC 02B .0200 for the discharge of fill material to waters and wetland areas as described in 33 CFR 330 Appendix A (B) (33) and for the Riparian Area Protection Rules (Buffer Rules) in 15A NCAC 02B .0200.

The State of North Carolina certifies that the specified category of activity will not violate applicable portions of Sections 301, 302, 303, 306 and 307 of the Public Laws 92-500 and 95-217 if conducted in accordance with the conditions hereinafter set forth.

**Activities meeting any one (1) of the following thresholds or circumstances require written approval for a 401 Water Quality Certification from the Division of Water Quality (the "Division"):**

- a. Any stream relocation; or
  - b. Any impact associated with a Notice of Violation or an enforcement action for violation(s) of DWQ Wetland Rules (15A NCAC 02H .0500), Isolated Wetland Rules (15A NCAC 02H .1300), DWQ Surface Water or Wetland Standards, or Riparian Buffer Rules (15A NCAC 02B .0200); or
  - \* c. Any impacts to streams and/or buffers in the Neuse, Tar-Pamlico, or Catawba River Basins or in the Randleman, Jordan or Goose Creek Watersheds (or any other basin or watershed with Riparian Area Protection Rules [Buffer Rules] in effect at the time of application) *unless* the activities are listed as "EXEMPT" from these rules or a Buffer Authorization Certificate is issued through N.C. Division of Coastal Management (DCM) delegation for "ALLOWABLE" activities.
- \* In accordance with North Carolina General Statute 143-215.3D(e), written approval for a 401 Water Quality General Certification must include the appropriate fee. If a project also requires a CAMA Permit, then one payment to both agencies shall be submitted and will be the higher of the two fees.

**Activities included in this General Certification that do not meet one of the thresholds listed above do not require written approval from the Division as long as they comply with the Conditions of Certification listed below. If any of these Conditions cannot be met, then written approval from the Division is required.**

Conditions of Certification:

1. No Impacts Beyond those Authorized in the Written Approval or Beyond the Threshold of Use of this Certification

No waste, spoil, solids, or fill of any kind shall occur in wetlands, waters, or riparian areas beyond the footprint of the impacts depicted in the Pre-Construction Notification, as authorized in the written approval from the Division or beyond the thresholds established for use of this Certification without written authorization, including incidental impacts. All construction activities, including the design, installation, operation, and maintenance of sediment and erosion control Best Management Practices shall be performed so that no violations of state water quality standards, statutes, or rules occur. Approved plans and specifications for this project are incorporated by reference and are enforceable parts of this permit.



# P-51

## Water Quality Certification No. 3893

### 2. Standard Erosion and Sediment Control Practices

Erosion and sediment control practices must be in full compliance with all specifications governing the proper design, installation and operation and maintenance of such Best Management Practices and if applicable, comply with the specific conditions and requirements of the NPDES Construction Stormwater Permit issued to the site:

- a. Design, installation, operation, and maintenance of the sediment and erosion control measures must be such that they equal or exceed the requirements specified in the most recent version of the *North Carolina Sediment and Erosion Control Manual*. The devices shall be maintained on all construction sites, borrow sites, and waste pile (spoil) projects, including contractor-owned or leased borrow pits associated with the project.
- b. For borrow pit sites, the erosion and sediment control measures must be designed, installed, operated, and maintained in accordance with the most recent version of the *North Carolina Surface Mining Manual*.
- c. Reclamation measures and implementation must comply with the reclamation in accordance with the requirements of the Sedimentation Pollution Control Act and the Mining Act of 1971.
- d. Sufficient materials required for stabilization and/or repair of erosion control measures and stormwater routing and treatment shall be on site at all times.
- e. If the project occurs in waters or watersheds classified as Primary Nursery Areas (PNAs), SA, WS-I, WS-II, High Quality (HQW), or Outstanding Resource (ORW) waters, then the sedimentation and erosion control designs must comply with the requirements set forth in 15A NCAC 04B .0124, *Design Standards in Sensitive Watersheds*.

### 3. No Sediment and Erosion Control Measures in Wetlands or Waters

Sediment and erosion control measures shall not be placed in wetlands or waters. Exceptions to this condition require application submittal to and written approval by the Division. If placement of sediment and erosion control devices in wetlands and waters is unavoidable, then design and placement of temporary erosion control measures shall not be conducted in a manner that may result in dis-equilibrium of wetlands, stream beds, or banks, adjacent to or upstream and downstream of the above structures. All sediment and erosion control devices shall be removed and the natural grade restored within two (2) months of the date that the Division of Land Resources (DLR) or locally delegated program has released the specific area within the project.

### 4. Construction Stormwater Permit NCG010000

An NPDES Construction Stormwater Permit is required for construction projects that disturb one (1) or more acres of land. This Permit allows stormwater to be discharged during land disturbing construction activities as stipulated in the conditions of the permit. If your project is covered by this permit, full compliance with permit conditions including the erosion & sedimentation control plan, inspections and maintenance, self-monitoring, record keeping and reporting requirements is required. A copy of the general permit (NCG010000), inspection log sheets, and other information may be found at <http://portal.ncdenr.org/web/wq/ws/su/npdcssw#tab-w>.

The North Carolina Department of Transportation (NCDOT) shall be required to be in full compliance with the conditions related to construction activities within the most recent version of their individual NPDES (NCS000250) stormwater permit.



## P-52

# Water Quality Certification No. 3893

### 5. Construction Moratoriums and Coordination

If activities must occur during periods of high biological activity (i.e. sea turtle nesting, fish spawning, or bird nesting), then biological monitoring may be required at the request of other state or federal agencies and coordinated with these activities.

All moratoriums on construction activities established by the NC Wildlife Resources Commission (WRC), US Fish and Wildlife Service (USFWS), NC Division of Marine Fisheries (DMF), or National Marine Fisheries Service (NMFS) to lessen impacts on trout, anadromous fish, larval/post-larval fishes and crustaceans, or other aquatic species of concern shall be implemented. Exceptions to this condition require written approval by the resource agency responsible for the given moratorium.

Work within the twenty-five (25) designated trout counties or identified state or federal endangered or threatened species habitat shall be coordinated with the appropriate WRC, USFWS, NMFS, and/or DMF personnel.

### 6. Work in the Dry

All work in or adjacent to stream waters shall be conducted so that the flowing stream does not come in contact with the disturbed area. Approved best management practices from the most current version of the NC Sediment and Erosion Control Manual, or the NC DOT Construction and Maintenance Activities Manual, such as sandbags, rock berms, cofferdams, and other diversion structures shall be used to minimize excavation in flowing water. Exceptions to this condition require application submittal to and written approval by the Division.

### 7. Riparian Area Protection (Buffer) Rules

Activities located in the protected riparian areas (whether jurisdictional wetlands or not), within the Neuse, Tar-Pamlico, or Catawba River Basins or in the Randleman, Jordan, or Goose Creek Watersheds (or any other basin or watershed with buffer rules) shall be limited to "uses" identified within and constructed in accordance with 15A NCAC 02B .0233, .0259, .0243, .0250, .0267 and .0605, and shall be located, designed, constructed, and maintained to have minimal disturbance to protect water quality to the maximum extent practicable through the use of best management practices. All buffer rule requirements, including diffuse flow requirements, must be met.

8. If concrete is used during the construction, then all necessary measures shall be taken to prevent direct contact between uncured or curing concrete and waters of the state. Water that inadvertently contacts uncured concrete shall not be discharged to waters of the state due to the potential for elevated pH and possible aquatic life/ fish kills.
9. Bridge deck drains shall not discharge directly into the stream. Stormwater shall be directed across the bridge and pre-treated through site-appropriate means (grassed swales, pre-formed scour holes, vegetated buffers, etc.) before entering the stream. Please refer to the most current version of *Stormwater Best Management Practices*. Exceptions to this condition require written approval by the Division.
10. Placement of culverts and other structures in Waters and Wetlands

Culverts required for this project shall be designed and installed in such a manner that the original stream profiles are not altered and allow for aquatic life movement during low flows. Existing stream dimensions (including the cross section dimensions, pattern, and longitudinal profile) must be maintained above and below locations of each culvert.



# P-53

## Water Quality Certification No. 3893

Placement of culverts and other structures in waters and streams must be below the elevation of the streambed by one foot for all culverts with a diameter greater than 48 inches, and 20 percent of the culvert diameter for culverts having a diameter less than or equal to 48 inches, to allow low flow passage of water and aquatic life.

When topographic constraints indicate culvert slopes of greater than 5%, culvert burial is not required, provided that all alternative options for flattening the slope have been investigated and aquatic life movement/ connectivity has been provided when possible (rock ladders, crossvanes, etc). Notification to the Division including supporting documentation to include a location map of the culvert, culvert profile drawings, and slope calculations shall be provided to the Division 60 days prior to the installation of the culvert.

When bedrock is present in culvert locations, culvert burial is not required provided that there is sufficient documentation of the presence of bedrock. Notification to the Division including supporting documentation such as, but not limited to, a location map of the culvert, geotechnical reports, photographs, etc shall be provided to the Division a minimum of 60 days prior to the installation of the culvert. If bedrock is discovered during construction, then the Division shall be notified by phone or email within 24 hours of discovery.

If other site-specific topographic constraints preclude the ability to bury the culverts as described above and/or it can be demonstrated that burying the culvert would result in destabilization of the channel, then exceptions to this condition require application submittal to, and written approval by, the Division of Water Quality, regardless of the total impacts to streams or wetlands from the project.

Installation of culverts in wetlands must ensure continuity of water movement and be designed to adequately accommodate high water or flood conditions. Additionally, when roadways, causeways, or other fill projects are constructed across FEMA-designated floodways or wetlands, openings such as culverts or bridges must be provided to maintain the natural hydrology of the system as well as prevent constriction of the floodway that may result in destabilization of streams or wetlands.

The establishment of native, woody vegetation and other soft stream bank stabilization techniques must be used where practicable instead of riprap or other bank hardening methods.

### \* 11. Compensatory Mitigation

In accordance with 15A NCAC 02H .0506 (h), compensatory mitigation may be required for losses of equal to or greater than 150 linear feet of streams (intermittent and perennial) and/or equal to or greater than one (1) acre of wetlands. For linear public transportation projects, impacts equal to or exceeding 150 linear feet per stream shall require mitigation.

Buffer mitigation may be required for any project with Buffer Rules in effect at the time of application for activities classified as "Allowable with Mitigation" or "Prohibited" within the Table of Uses.

A determination of buffer, wetland, and stream mitigation requirements shall be made for any General Water Quality Certification for this Nationwide and/or Regional General Permit. Design and monitoring protocols shall follow the US Army Corps of Engineers Wilmington District *Stream Mitigation Guidelines* (April 2003) or its subsequent updates. Compensatory mitigation plans shall be submitted to the Division for written approval as required in those protocols. The mitigation plan must be implemented and/or constructed before any impacts occur on site. Alternatively, the Division will accept payment into an in-lieu fee program or a mitigation bank. In these cases, proof of payment shall be provided to the Division before any impacts occur on site.



**P-54**  
**Water Quality Certification No. 3893**

12. Relocated stream designs should include the same dimensions, patterns, and profiles as the existing channel (or a stable reference reach if the existing channel is unstable), to the maximum extent practical. The new channel should be constructed in the dry and water shall not be turned into the new channel until the banks are stabilized. Vegetation used for bank stabilization shall be limited to native woody species, and should include establishment of a 30-foot wide wooded and an adjacent 20-foot wide vegetated buffer on both sides of the relocated channel to the maximum extent practical. A transitional phase incorporating appropriate erosion control matting materials and seedling establishment is allowable, however matting that incorporates plastic mesh and/or plastic twine shall not be used in wetlands, riparian buffers or floodplains as recommended by the North Carolina Sediment and Erosion Control Manual. Rip-rap, A-Jacks, concrete, gabions or other hard structures may be allowed if it is necessary to maintain the physical integrity of the stream; however, the applicant must provide written justification and any calculations used to determine the extent of rip-rap coverage. Please note that if the stream relocation is conducted as a stream restoration as defined in the US Army Corps of Engineers Wilmington District, April 2003 *Stream Mitigation Guidelines* (or its subsequent updates), the restored length may be used as compensatory mitigation for the impacts resulting from the relocation.
13. All temporary fill and culverts shall be removed and the impacted area returned to natural conditions within 60 days of the determination that the temporary impact is no longer necessary. The impacted areas shall be restored to original grade, including each stream's original cross sectional dimensions, plan form pattern, and longitudinal bed and bed profile, and the various sites shall be stabilized with natural woody vegetation (except for the approved maintenance areas) and restored to prevent erosion.
14. Pipes shall be installed under the road or causeway in all streams to carry at least the 25-year storm event as outlined in the most recent edition of the *North Carolina Sediment and Erosion Control Planning and Design Manual* or the *North Carolina Surface Mining Manual* so as not to restrict stream flow during use of this General Certification.
- \* 15. If an environmental document is required under the National or State Environmental Policy Act (NEPA or SEPA), then this General Certification is not valid until a Finding of No Significant Impact (FONSI) or Record of Decision (ROD) is issued by the State Clearinghouse.
16. In the twenty (20) coastal counties, the appropriate DWQ Regional Office must be contacted to determine if Coastal Stormwater Regulations will be required.
17. This General Certification does not relieve the applicant of the responsibility to obtain all other required Federal, State, or Local approvals.
18. The applicant/permittee and their authorized agents shall conduct all activities in a manner consistent with State water quality standards (including any requirements resulting from compliance with §303(d) of the Clean Water Act), and any other appropriate requirements of State and Federal Law. If the Division determines that such standards or laws are not being met, including failure to sustain a designated or achieved use, or that State or Federal law is being violated, or that further conditions are necessary to assure compliance, then the Division may reevaluate and modify this General Water Quality Certification.
- \* 19. When written authorization is required for use of this certification, upon completion of all permitted impacts included within the approval and any subsequent modifications, the applicant shall be required to return the certificate of completion attached to the approval. One copy of the certificate shall be sent to the DWQ Central Office in Raleigh at 1650 Mail Service Center, Raleigh, NC, 27699-1650.

**P-55**  
**Water Quality Certification No. 3893**

20. Additional site-specific conditions, including monitoring and/or modeling requirements, may be added to the written approval letter for projects proposed under this Water Quality Certification in order to ensure compliance with all applicable water quality and effluent standards.
21. This certification grants permission to the director, an authorized representative of the Director, or DENR staff, upon the presentation of proper credentials, to enter the property during normal business hours.

This General Certification shall expire on the same day as the expiration date of the corresponding Nationwide and/or Regional General Permit. The conditions in effect on the date of issuance of Certification for a specific project shall remain in effect for the life of the project, regardless of the expiration date of this Certification.

Non-compliance with or violation of the conditions herein set forth by a specific project may result in revocation of this General Certification for the project and may also result in criminal and/or civil penalties.

The Director of the North Carolina Division of Water Quality may require submission of a formal application for Individual Certification for any project in this category of activity if it is determined that the project is likely to have a significant adverse effect upon water quality, including state or federally listed endangered or threatened aquatic species, or degrade the waters so that existing uses of the wetland or downstream waters are precluded.

Public hearings may be held for specific applications or group of applications prior to a Certification decision if deemed in the public's best interest by the Director of the North Carolina Division of Water Quality.

Effective date: March 19, 2012

DIVISION OF WATER QUALITY

By



Charles Wakild, P.E.

Director

*History Note: Water Quality Certification (WQC) Number 3893 issued March 19, 2012 replaces WQC Number 3688 issued November 1, 2007; WQC Number 3634 issued March 19, 2007; WQC Number 3366 issued March 18, 2002; WQC Number 3114 issued February 11, 1997; and WQC Number 2727 issued May 1, 1992. This General Certification is rescinded when the Corps of Engineers reauthorizes any of the corresponding Nationwide and/or Regional General Permits or when deemed appropriate by the Director of the Division of Water Quality.*



STATE	N.C.	PROJECT NUMBER	B-5243
COUNTY	UNION	DATE	1
PROJECT	BRIDGE 258 ON SR 1008 OVER SOUTH FORK CROOKED CREEK AND IMPROVEMENT OF THE INTERSECTION OF SR 1009 AND SR 1371	DESIGNER	PE
CONTRACT		PROJECT ENGINEER	RW & UTIL
		PROJECT ENGINEER	CONST.



PERMIT DRAWING  
SHEET 1 OF 11

P-56

PRELIMINARY PLANS  
NO PART FOR USE IN CONSTRUCTION



STATE OF NORTH CAROLINA  
DIVISION OF HIGHWAYS

**UNION COUNTY**

LOCATION: BRIDGE 258 ON SR 1008 OVER SOUTH FORK CROOKED CREEK AND IMPROVEMENT OF THE INTERSECTION OF SR 1009 AND SR 1371

TYPE OF WORK: GRADING, DRAINAGE, PAVING, CULVERT AND SIGNAL

WETLAND AND SURFACE WATER IMPACTS PERMIT

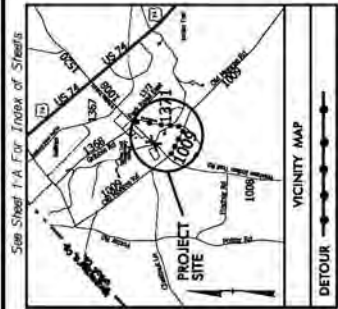

DETOUR  
THIS PROJECT IS WITHIN THE MUNICIPAL BOUNDARIES OF INDIAN TRAIL

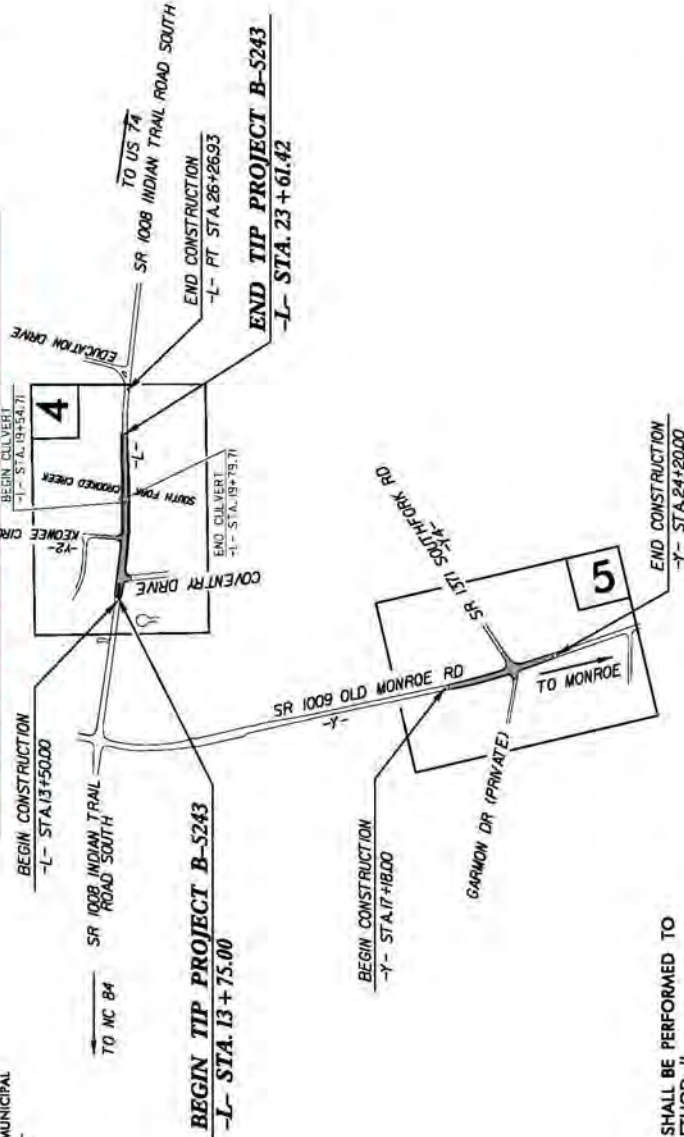

CLEARING ON THIS PROJECT SHALL BE PERFORMED TO THE LIMITS ESTABLISHED BY METHOD II

HYDRAULICS ENGINEER	P.E.
ROADWAY DESIGN ENGINEER	P.E.
PROJECT ENGINEER	I.T. YOUNIS
PROJECT DESIGN ENGINEER	

Prepared in the Office of:	
DIVISION OF HIGHWAYS	
1400 Bruce B. Bessie Dr., Raleigh, NC, 27601	
RIGHT OF WAY DATE:	G.E. BREW, PE
JANUARY 16, 2015	PROJECT ENGINEER
LETTING DATE:	I.T. YOUNIS
JANUARY 19, 2016	PROJECT DESIGN ENGINEER

PROJECT LENGTH	
LENGTH OF ROADWAY TIP PROJECT B-5243 = 0.182 MILES	
LENGTH STRUCTURE TIP PROJECT B-5243 = 0.005 MILES	
TOTAL LENGTH OF TIP PROJECT B-5243 = 0.187 MILES	

DESIGN DATA	
ADT 2016 = 15,900	
ADT 2036 = 19,350	
K = 9 %	
D = 65 %	
T = 5 %	
V = 40 MPH	
* ITST = 1% DUAL 4%	
FUNC CLASS = MAJOR COLLECTOR	
SUB REGIONAL TIER	

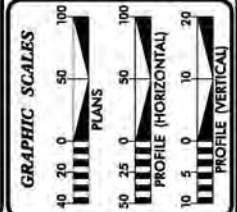

TIP PROJECT: B-5243

CONTRACT: C



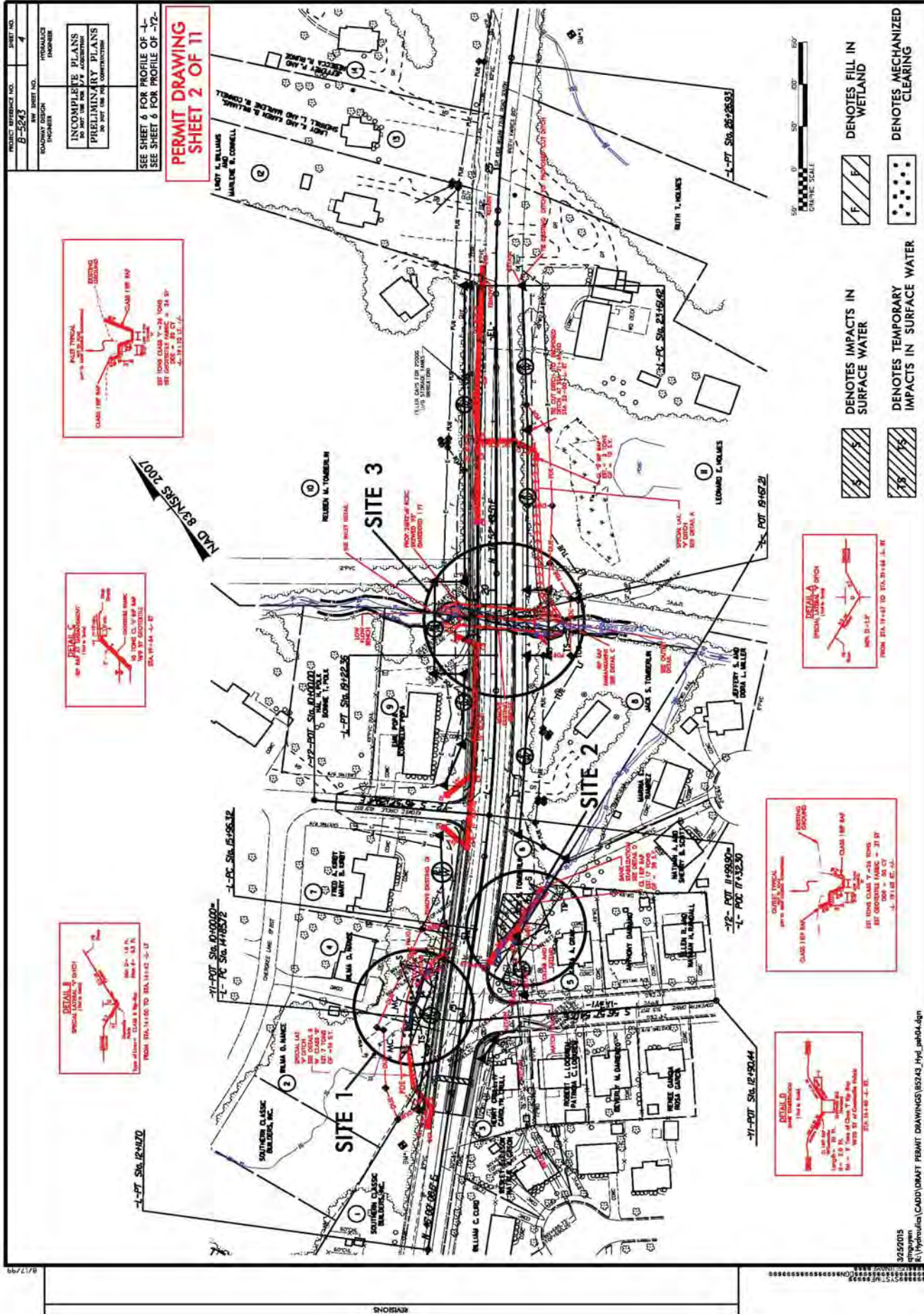



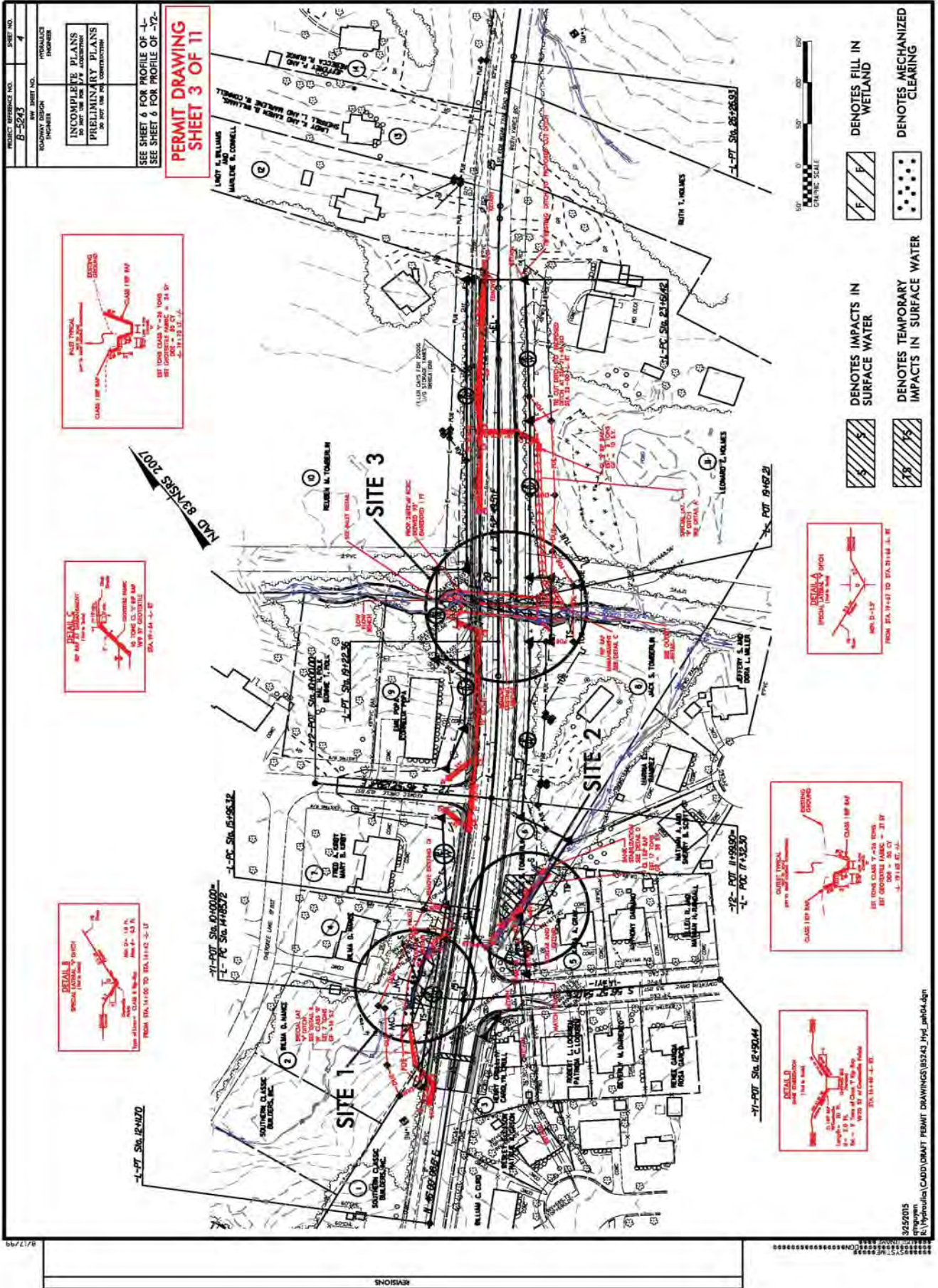

PROJECT REFERENCE NO.	B-5243	SHEET NO.	4
ROADWAY DESIGN ENGINEER	HYDRAULICS ENGINEER		
INCOMPLETE PLANS NOT FOR CONSTRUCTION PRELIMINARY PLANS FOR INFORMATION ONLY			
SEE SHEET 6 FOR PROFILE OF -L- SEE SHEET 6 FOR PROFILE OF -T-			

**PERMIT DRAWING  
SHEET 3 OF 11**

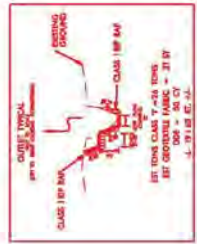

- DENOTES IMPACTS IN SURFACE WATER
- DENOTES TEMPORARY IMPACTS IN SURFACE WATER
- DENOTES FILL IN WETLAND
- DENOTES MECHANIZED CLEARING

3/25/2015  
 K:\Hydraulics\CADD\DRAW\PERMIT DRAWINGS\B5143\_Hyd\_per04.dgn



# SITE 1 ENLARGEMENT

NAD 83/NRS 2007

PROJECT REFERENCE NO. B-5243	SHEET NO. 1
ROADWAY DESIGN ENGINEER	HYDRAULICS ENGINEER
INCOMPLETE PLANS PRELIMINARY PLANS DO NOT USE FOR CONSTRUCTION	

PERMIT DRAWING  
SHEET 4 OF 11

P-59

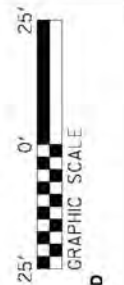
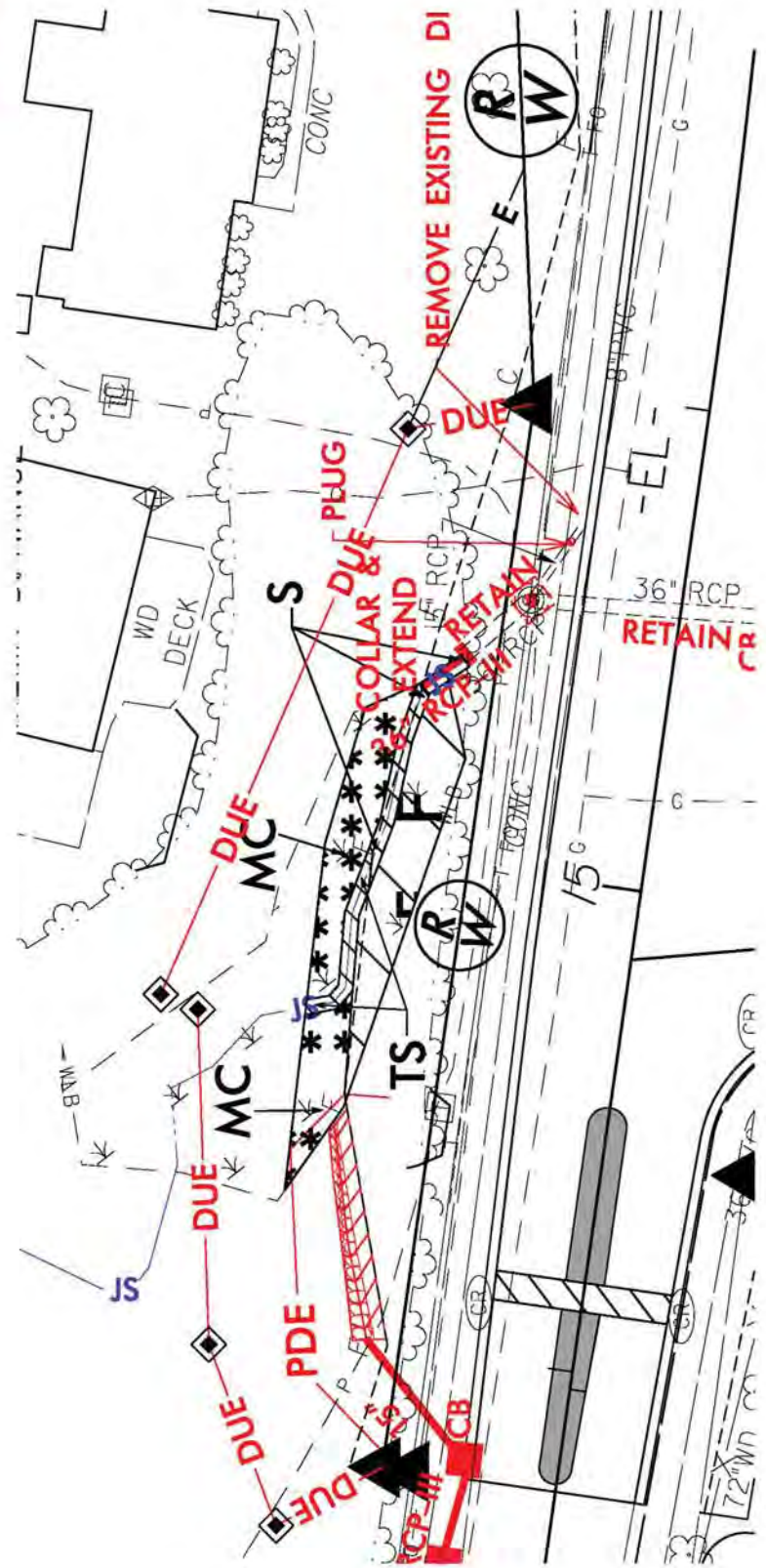

DENOTES FILL IN WETLAND

DENOTES MECHANIZED CLEARING

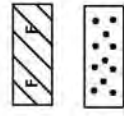

DENOTES IMPACTS IN SURFACE WATER

DENOTES TEMPORARY IMPACTS IN SURFACE WATER

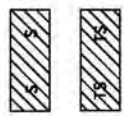

3/25/2015  
qimguyen  
R:\Hydraulics\CADD\PERMIT DRAWINGS\B5243\_Hyd\_psh04\_site1.dgn

8/17/2015

REVISIONS

# SITE 1 ENLARGEMENT

NAD 83/NRS 2007

PROJECT REFERENCE NO.	B-5243	SHEET NO.	1
RDW SHEET NO.		HYDRAULICS ENGINEER	
INCOMPLETE PLANS IN PRELIMINARY STAGE PRELIMINARY PLANS DO NOT TAKE ANY ACTION			

PERMIT DRAWING  
SHEET 5 OF 11

P-60

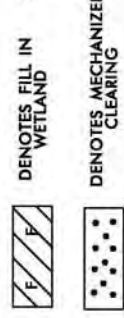
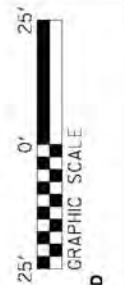
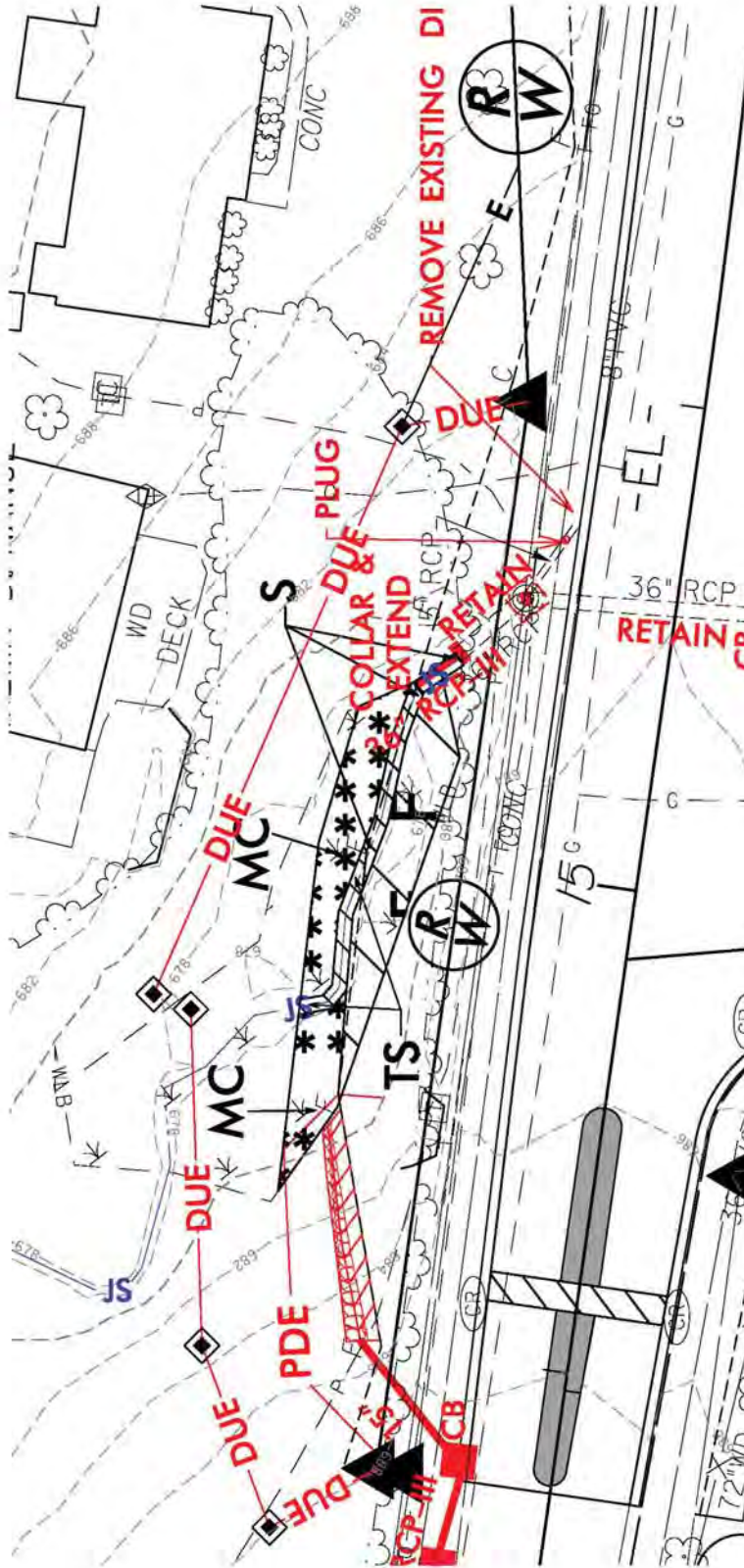

3/25/2015  
qmguyen  
R:\Hydraulics\CADD\PROJECT PERMIT DRAWINGS\B5243\_Hyd\_psh04\_site1.dgn

REVISIONS



# SITE 2 ENLARGEMENT

MAD 83/NSRS 2007

PROJECT REFERENCE NO.	B-5243	SHEET NO.	4
RDW SHEET NO.		HYDRAULICS ENGINEER	
INCOMPLETE PLANS AND/OR PRELIMINARY PLANS TO NOT BE USED FOR CONSTRUCTION			

PERMIT DRAWING  
SHEET 6 OF 11

P-61

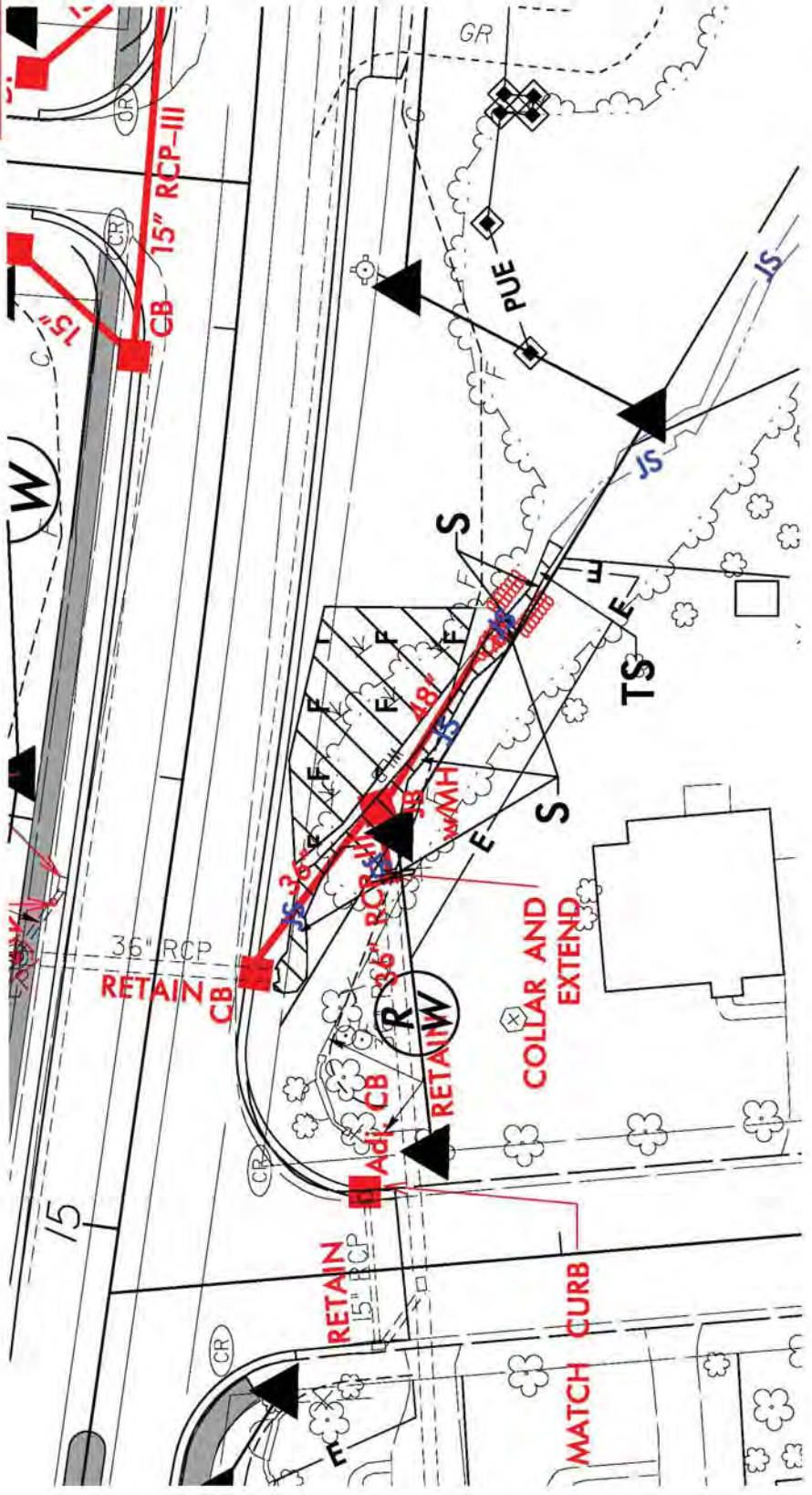

- DENOTES IMPACTS IN SURFACE WATER
- DENOTES IMPACTS IN SURFACE WATER
- DENOTES TEMPORARY IMPACTS IN SURFACE WATER
- DENOTES FILL IN WETLAND

3/25/2015  
gnguyen  
K:\Hydraulics\CADD\DRIFT PERMIT DRAWINGS\B5243\_Hyd\_per04\_sine2.dgn

9/17/2015

REVISIONS



# SITE 2 ENLARGEMENT

MAD 83/NSRS 2007

PROJECT REFERENCE NO. B-5243  
SHEET NO. 4  
HYDRAULICS ENGINEER  
ROADWAY DESIGN ENGINEER  
INCOMPLETE PLANS  
PRELIMINARY PLANS  
DO NOT SCALE OR REPRODUCE

PERMIT DRAWING  
SHEET 7 OF 11

P-62

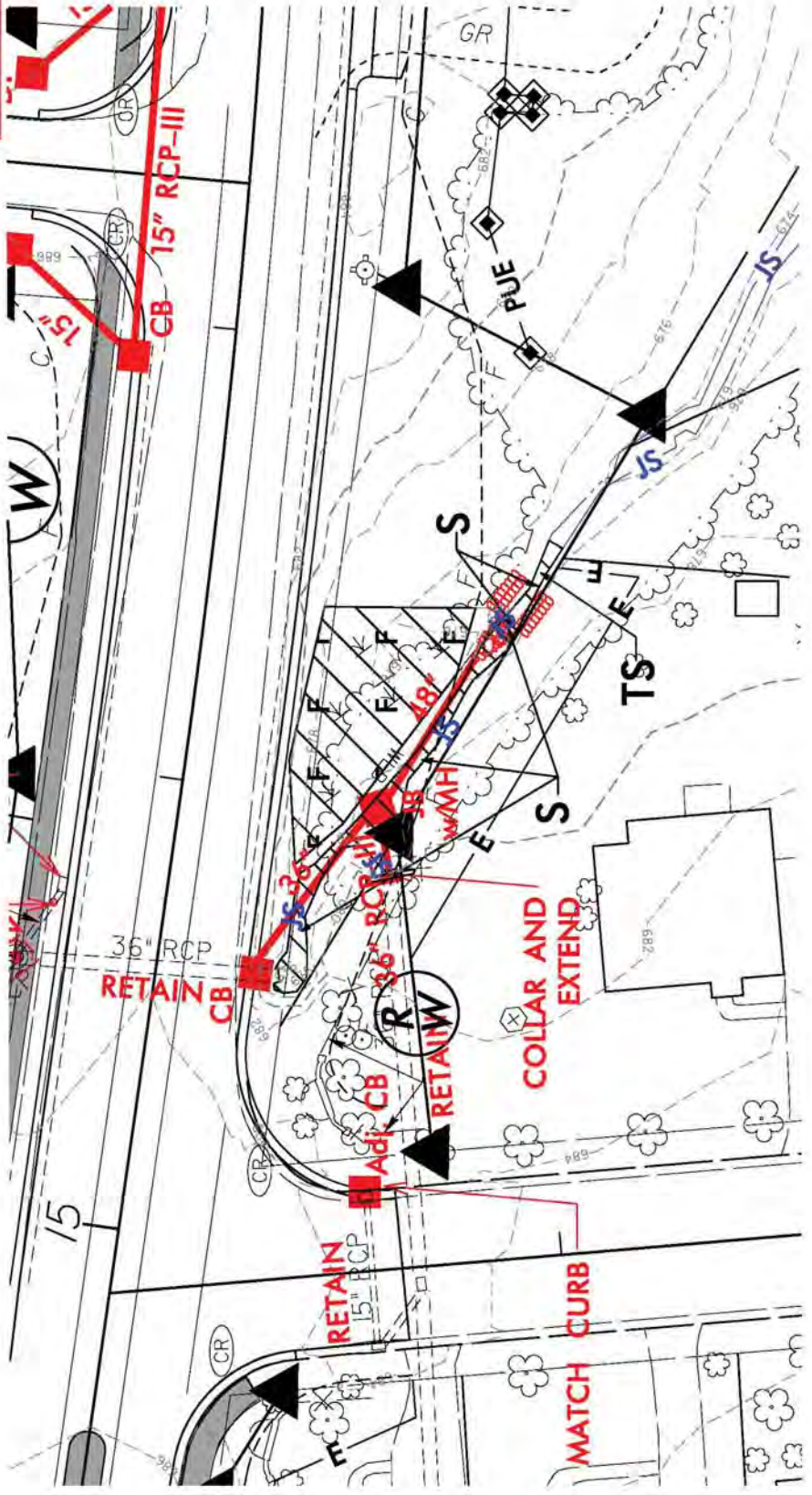

DEMOTES FILL IN WETLAND

DEMOTES TEMPORARY IMPACTS IN SURFACE WATER

DEMOTES IMPACTS IN SURFACE WATER

DEMOTES IMPACTS IN SURFACE WATER

DEMOTES IMPACTS IN SURFACE WATER

DEMOTES IMPACTS IN SURFACE WATER

DEMOTES IMPACTS IN SURFACE WATER

DEMOTES IMPACTS IN SURFACE WATER

DEMOTES IMPACTS IN SURFACE WATER

DEMOTES IMPACTS IN SURFACE WATER

DEMOTES IMPACTS IN SURFACE WATER

DEMOTES IMPACTS IN SURFACE WATER

DEMOTES IMPACTS IN SURFACE WATER

DEMOTES IMPACTS IN SURFACE WATER

DEMOTES IMPACTS IN SURFACE WATER

DEMOTES IMPACTS IN SURFACE WATER

DEMOTES IMPACTS IN SURFACE WATER

3/25/2015  
gmguyen  
K:\Hydraulics\CADD\DRIFT PERMIT DRAWINGS\B5243\_Hyd\_pch04\_sine2.dgn

REVISIONS

8/17/2015

# SITE 3 ENLARGEMENT

PROJECT REFERENCE NO.	SHEET NO.
B-5243	4
ROADWAY DESIGN ENGINEER	HYDRAULICS ENGINEER
INCOMPLETE PLANS FOR PERMITTING PRELIMINARY PLANS DO NOT TAKE ANY ACTION	

PERMIT DRAWING  
SHEET 8 OF 11

P-63

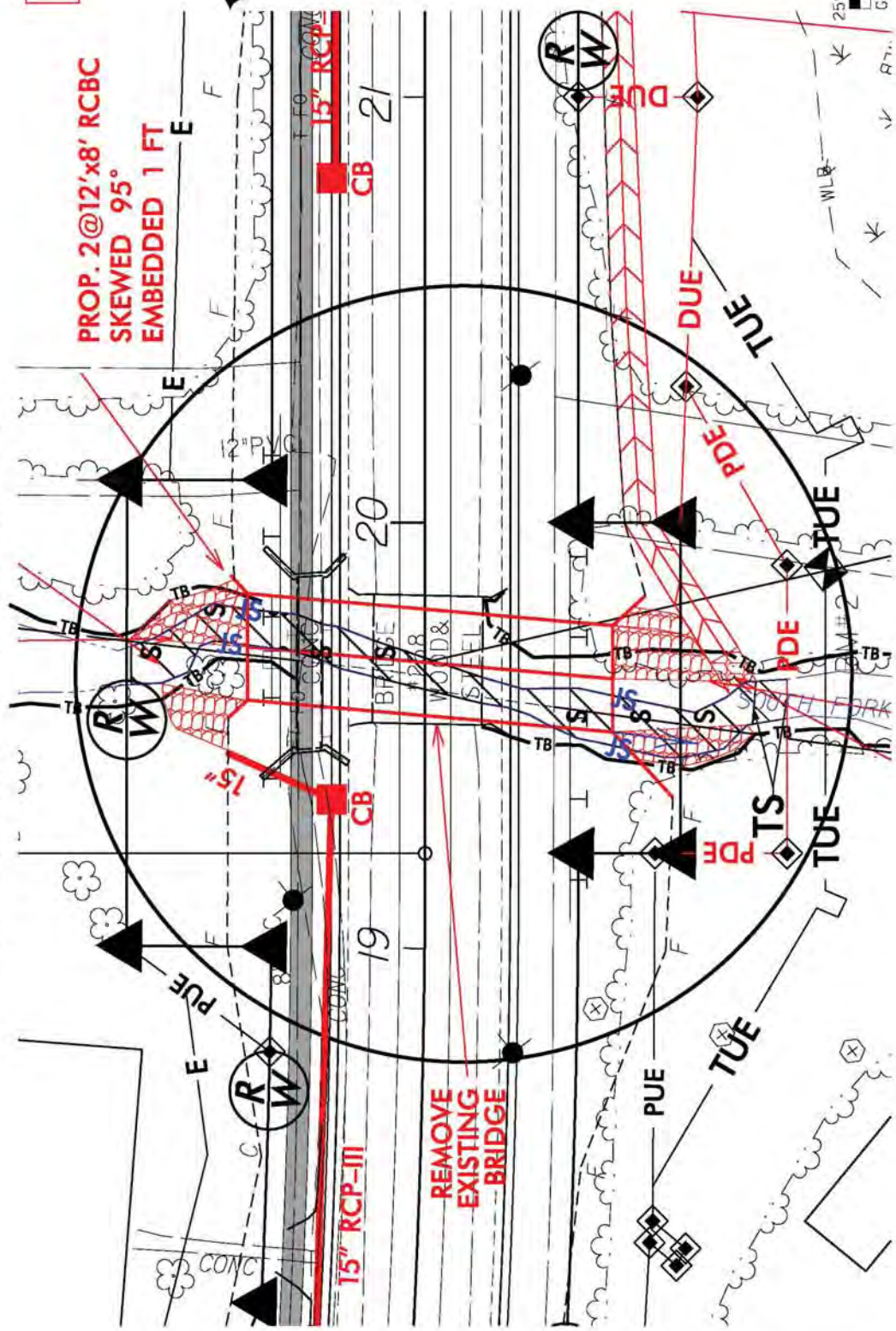

PROP. 2@12'x8' RCBC  
SKEWED 95°  
EMBEDDED 1 FT

REMOVE  
EXISTING  
BRIDGE

MAD BANKS 2007



DENOTES IMPACTS IN SURFACE WATER  
 DENOTES TEMPORARY IMPACTS IN SURFACE WATER

3252015  
cmguyen  
R:\Hydraulics\CADD\PERMIT DRAWINGS\B5243\_Hyd\_per04\_site3.dgn

8/17/2015

REVISIONS



# SITE 3 ENLARGEMENT

PROJECT REFERENCE NO.	B-5243	SHEET NO.	4
ROADWAY DESIGN ENGINEER	HYDRAULICS ENGINEER		
INCOMPLETE PLANS OR PRELIMINARY PLANS DO NOT BE USED FOR CONSTRUCTION			

**PERMIT DRAWING  
SHEET 9 OF 11**

**MAD BANSKS 2007**

**P-64**

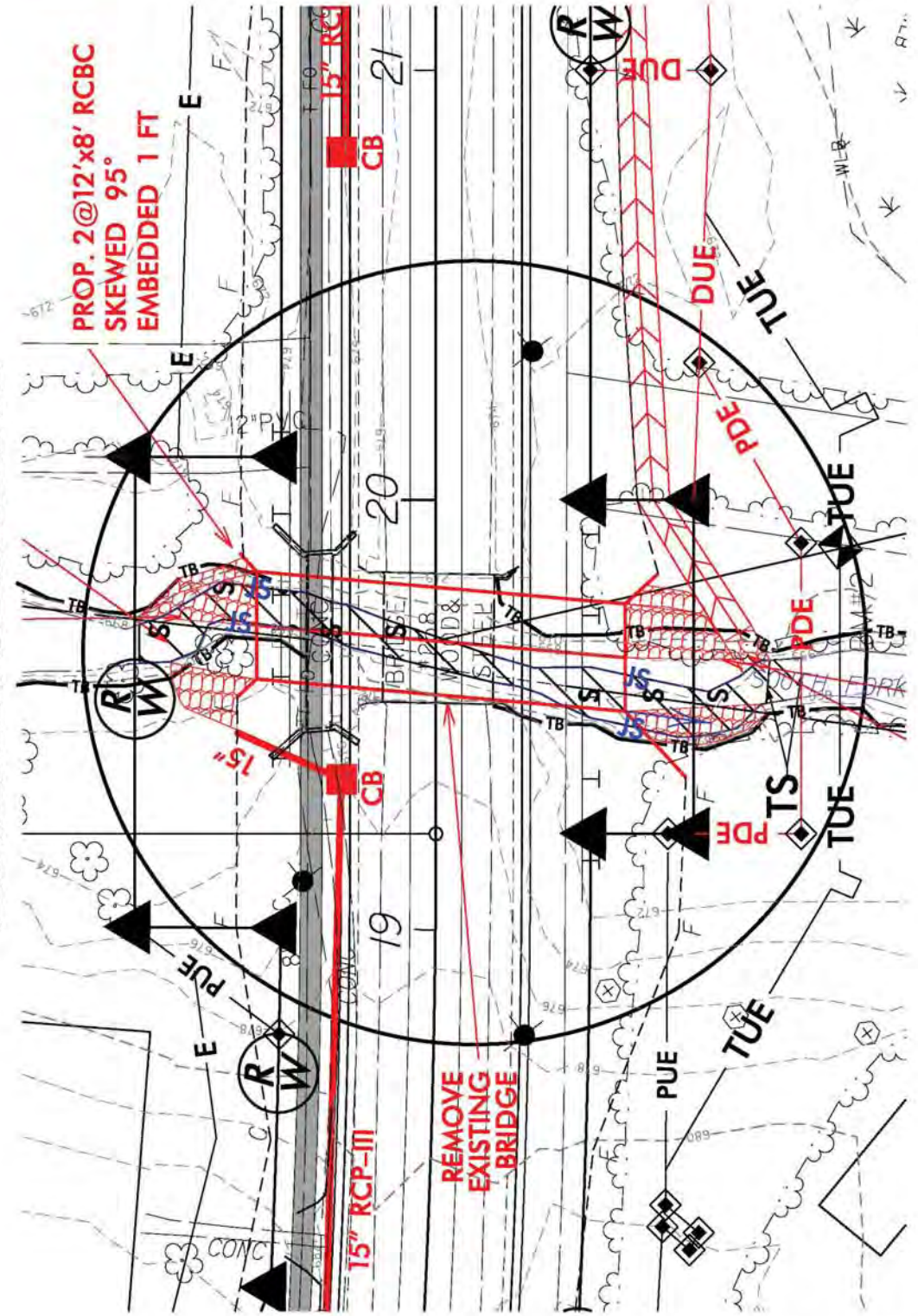

DENOTES IMPACTS IN SURFACE WATER  
 DENOTES TEMPORARY IMPACTS IN SURFACE WATER

3252015  
 cimguyen  
 R:\Hydraulics\CADD\PERMIT DRAWINGS\B5243\_Hyd\_per04\_site3.dgn

9/17/2015

REVISIONS





WETLAND PERMIT IMPACT SUMMARY																	
Site No.	Station (From/To)	Structure Size / Type	WETLAND IMPACTS					SURFACE WATER IMPACTS									
			Permanent Fill In Wetlands (ac)	Temp. Fill In Wetlands (ac)	Excavation in Wetlands (ac)	Mechanized Clearing in Wetlands (ac)	Hand Clearing in Wetlands (ac)	Permanent SW impacts (ac)	Temp. SW impacts (ac)	Existing Channel Impacts Permanent (ft)	Existing Channel Impacts Temp. (ft)	Natural Stream Design (ft)					
1	14+48 TO 15+37 -L- LT	ROAD FILL	0.02														
1	14+28 TO 14+71 -L- LT	ROAD FILL				< 0.01											
1	14+68 TO 15+34 -L- LT	ROAD FILL				0.01											
1	14+65 TO 15+01 -L- LT	STREAM INSIDE MC															
1	15+01 TO 15+35 -L- LT	ROAD FILL															
1	15+35 TO 15+43 -L- LT	36" RCP															
2	15+85 TO 14+61 -L- RT	ROAD FILL	0.03														
2	15+87 TO 16+43 -L- RT	STREAM IMPACT (36" & 48" ALT.)															
2	16+43 TO 16+53 -L- RT	BANK STABILIZATION															
3	19+47 TO 19+80 -L-	2 @ 12'X8' RCBC SOUTH FORK CROOK CREEK															
<b>TOTALS*:</b>			0.05			0.02				0.04	< 0.01	308	55				0

\*Rounded totals are sum of actual impacts

NOTES:

NC DEPARTMENT OF TRANSPORTATION  
 DIVISION OF HIGHWAYS  
 3/25/2015  
 UNION COUNTY  
 B-5243  
 WBS 42845.1.1  
 SHEET 11 OF 11

County : Union

Line #	Item Number	Sec #	Description	Quantity	Unit Cost	Amount
<b>ROADWAY ITEMS</b>						
0001	0000100000-N	800	MOBILIZATION	Lump Sum	L.S.	
0002	0000400000-N	801	CONSTRUCTION SURVEYING	Lump Sum	L.S.	
0003	0043000000-N	226	GRADING	Lump Sum	L.S.	
0004	0050000000-E	226	SUPPLEMENTARY CLEARING & GRUB-BING	1 ACR		
0005	0057000000-E	226	UNDERCUT EXCAVATION	950 CY		
0006	0134000000-E	240	DRAINAGE DITCH EXCAVATION	100 CY		
0007	0195000000-E	265	SELECT GRANULAR MATERIAL	500 CY		
0008	0196000000-E	270	GEOTEXTILE FOR SOIL STABILIZATION	1,300 SY		
0009	0318000000-E	300	FOUNDATION CONDITIONING MATERIAL, MINOR STRUCTURES	353 TON		
0010	0320000000-E	300	FOUNDATION CONDITIONING GEOTEXTILE	1,110 SY		
0011	0335200000-E	305	15" DRAINAGE PIPE	136 LF		
0012	0335300000-E	305	18" DRAINAGE PIPE	32 LF		
0013	0335600000-E	305	36" DRAINAGE PIPE	44 LF		
0014	0335800000-E	305	48" DRAINAGE PIPE	40 LF		
0015	0342000000-E	310	*** SIDE DRAIN PIPE (12")	48 LF		
0016	0343000000-E	310	15" SIDE DRAIN PIPE	64 LF		
0017	0366000000-E	310	15" RC PIPE CULVERTS, CLASS III	652 LF		
0018	0372000000-E	310	18" RC PIPE CULVERTS, CLASS III	40 LF		
0019	0390000000-E	310	36" RC PIPE CULVERTS, CLASS III	28 LF		

County : Union

Line #	Item Number	Sec #	Description	Quantity	Unit Cost	Amount
0020	0995000000-E	340	PIPE REMOVAL	140		LF
0021	1099500000-E	505	SHALLOW UNDERCUT	500		CY
0022	1099700000-E	505	CLASS IV SUBGRADE STABILIZATION	540		TON
0023	1220000000-E	545	INCIDENTAL STONE BASE	150		TON
0024	1330000000-E	607	INCIDENTAL MILLING	280		SY
0025	1489000000-E	610	ASPHALT CONC BASE COURSE, TYPE B25.0B	960		TON
0026	1498000000-E	610	ASPHALT CONC INTERMEDIATE COURSE, TYPE 119.0B	990		TON
0027	1519000000-E	610	ASPHALT CONC SURFACE COURSE, TYPE S9.5B	1,560		TON
0028	1575000000-E	620	ASPHALT BINDER FOR PLANT MIX	185		TON
0029	1693000000-E	654	ASPHALT PLANT MIX, PAVEMENT REPAIR	225		TON
0030	2000000000-N	806	RIGHT OF WAY MARKERS	39		EA
0031	2022000000-E	815	SUBDRAIN EXCAVATION	45		CY
0032	2026000000-E	815	GEOTEXTILE FOR SUBSURFACE DRAINS	200		SY
0033	2036000000-E	815	SUBDRAIN COARSE AGGREGATE	35		CY
0034	2044000000-E	815	6" PERFORATED SUBDRAIN PIPE	200		LF
0035	2077000000-E	815	6" OUTLET PIPE	6		LF
0036	2132000000-N	816	CONCRETE PAD FOR SHOULDER DRAIN PIPE OUTLET	1		EA
0037	2253000000-E	840	PIPE COLLARS	2		CY
0038	2275000000-E	SP	FLOWABLE FILL	1		CY



County : Union

Line #	Item Number	Sec #	Description	Quantity	Unit Cost	Amount
0039	2286000000-N	840	MASONRY DRAINAGE STRUCTURES	15	EA	
0040	2308000000-E	840	MASONRY DRAINAGE STRUCTURES	5	LF	
0041	2364000000-N	840	FRAME WITH TWO GRATES, STD 840.16	2	EA	
0042	2366000000-N	840	FRAME WITH TWO GRATES, STD 840.24	2	EA	
0043	2374000000-N	840	FRAME WITH GRATE & HOOD, STD 840.03, TYPE ** (E)	4	EA	
0044	2374000000-N	840	FRAME WITH GRATE & HOOD, STD 840.03, TYPE ** (F)	1	EA	
0045	2374000000-N	840	FRAME WITH GRATE & HOOD, STD 840.03, TYPE ** (G)	5	EA	
0046	2396000000-N	840	FRAME WITH COVER, STD 840.54	1	EA	
0047	2549000000-E	846	2'-6" CONCRETE CURB & GUTTER	1,775	LF	
0048	2591000000-E	848	4" CONCRETE SIDEWALK	590	SY	
0049	2605000000-N	848	CONCRETE CURB RAMP	6	EA	
0050	2612000000-E	848	6" CONCRETE DRIVEWAY	35	SY	
0051	2655000000-E	852	5" MONOLITHIC CONCRETE ISLANDS (KEYED IN)	65	SY	
0052	2800000000-N	858	ADJUSTMENT OF CATCH BASINS	1	EA	
0053	2830000000-N	858	ADJUSTMENT OF MANHOLES	4	EA	
0054	3030000000-E	862	STEEL BM GUARDRAIL	150	LF	
0055	3150000000-N	862	ADDITIONAL GUARDRAIL POSTS	5	EA	
0056	3210000000-N	862	GUARDRAIL ANCHOR UNITS, TYPE CAT-1	2	EA	

County : Union

Line #	Item Number	Sec #	Description	Quantity	Unit Cost	Amount
0057	3270000000-N	SP	GUARDRAIL ANCHOR UNITS, TYPE 350	2 EA		
0058	3575000000-E	SP	GENERIC FENCING ITEM VINYL COATED GLARE SCREEN (GUARDRAIL MOUNTED)	50 LF		
0059	3628000000-E	876	RIP RAP, CLASS I	78 TON		
0060	3635000000-E	876	RIP RAP, CLASS II	10 TON		
0061	3649000000-E	876	RIP RAP, CLASS B	10 TON		
0062	3656000000-E	876	GEOTEXTILE FOR DRAINAGE	813 SY		
0063	4072000000-E	903	SUPPORTS, 3-LB STEEL U-CHANNEL	275 LF		
0064	4102000000-N	904	SIGN ERECTION, TYPE E	19 EA		
0065	4155000000-N	907	DISPOSAL OF SIGN SYSTEM, U-CHANNEL	11 EA		
0066	4400000000-E	1110	WORK ZONE SIGNS (STATIONARY)	582 SF		
0067	4405000000-E	1110	WORK ZONE SIGNS (PORTABLE)	144 SF		
0068	4410000000-E	1110	WORK ZONE SIGNS (BARRICADE MOUNTED)	123 SF		
0069	4430000000-N	1130	DRUMS	54 EA		
0070	4435000000-N	1135	CONES	37 EA		
0071	4445000000-E	1145	BARRICADES (TYPE III)	96 LF		
0072	4455000000-N	1150	FLAGGER	180 DAY		
0073	4650000000-N	1251	TEMPORARY RAISED PAVEMENT MARKERS	45 EA		
0074	4685000000-E	1205	THERMOPLASTIC PAVEMENT MARKING LINES (4", 90 MILS)	2,293 LF		
0075	4686000000-E	1205	THERMOPLASTIC PAVEMENT MARKING LINES (4", 120 MILS)	5,085 LF		

County : Union

Line #	Item Number	Sec #	Description	Quantity	Unit Cost	Amount
0076	4695000000-E	1205	THERMOPLASTIC PAVEMENT MARKING LINES (8", 90 MILS)	180	LF	
0077	4710000000-E	1205	THERMOPLASTIC PAVEMENT MARKING LINES (24", 120 MILS)	132	LF	
0078	4721000000-E	1205	THERMOPLASTIC PAVEMENT MARKING CHARACTER (120 MILS)	6	EA	
0079	4725000000-E	1205	THERMOPLASTIC PAVEMENT MARKING SYMBOL (90 MILS)	8	EA	
0080	4810000000-E	1205	PAINT PAVEMENT MARKING LINES (4")	7,193	LF	
0081	4820000000-E	1205	PAINT PAVEMENT MARKING LINES (8")	32	LF	
0082	4835000000-E	1205	PAINT PAVEMENT MARKING LINES (24")	174	LF	
0083	4845000000-N	1205	PAINT PAVEMENT MARKING SYMBOL	8	EA	
0084	4900000000-N	1251	PERMANENT RAISED PAVEMENT MARKERS	33	EA	
0085	5325600000-E	1510	6" WATER LINE	1,138	LF	
0086	5325800000-E	1510	8" WATER LINE	686	LF	
0087	5540000000-E	1515	6" VALVE	5	EA	
0088	5546000000-E	1515	8" VALVE	2	EA	
0089	5648000000-N	1515	RELOCATE WATER METER	9	EA	
0090	5649000000-N	1515	RECONNECT WATER METER	5	EA	
0091	5672000000-N	1515	RELOCATE FIRE HYDRANT	2	EA	
0092	5691300000-E	1520	8" SANITARY GRAVITY SEWER	393	LF	
0093	5775000000-E	1525	4' DIA UTILITY MANHOLE	3	EA	
0094	5781000000-E	1525	UTILITY MANHOLE WALL, 4' DIA	13	LF	

County : Union

Line #	Item Number	Sec #	Description	Quantity	Unit Cost	Amount
0095	5800000000-E	1530	ABANDON 6" UTILITY PIPE	1,010 LF		
0096	5801000000-E	1530	ABANDON 8" UTILITY PIPE	1,034 LF		
0097	5816000000-N	1530	ABANDON UTILITY MANHOLE	1 EA		
0098	5828000000-N	1530	REMOVE UTILITY MANHOLE	2 EA		
0099	5835600000-E	1540	12" ENCASEMENT PIPE	60 LF		
0100	6000000000-E	1605	TEMPORARY SILT FENCE	2,860 LF		
0101	6006000000-E	1610	STONE FOR EROSION CONTROL, CLASS A	285 TON		
0102	6009000000-E	1610	STONE FOR EROSION CONTROL, CLASS B	160 TON		
0103	6012000000-E	1610	SEDIMENT CONTROL STONE	390 TON		
0104	6015000000-E	1615	TEMPORARY MULCHING	4 ACR		
0105	6018000000-E	1620	SEED FOR TEMPORARY SEEDING	300 LB		
0106	6021000000-E	1620	FERTILIZER FOR TEMPORARY SEED- ING	2.5 TON		
0107	6024000000-E	1622	TEMPORARY SLOPE DRAINS	200 LF		
0108	6029000000-E	SP	SAFETY FENCE	200 LF		
0109	6030000000-E	1630	SILT EXCAVATION	400 CY		
0110	6036000000-E	1631	MATTING FOR EROSION CONTROL	5,000 SY		
0111	6037000000-E	SP	COIR FIBER MAT	100 SY		
0112	6038000000-E	SP	PERMANENT SOIL REINFORCEMENT MAT	120 SY		
0113	6042000000-E	1632	1/4" HARDWARE CLOTH	850 LF		
0114	6070000000-N	1639	SPECIAL STILLING BASINS	6 EA		

County : Union

Line #	Item Number	Sec #	Description	Quantity	Unit Cost	Amount
0115	6071010000-E	SP	WATTLE	270		LF
0116	6071020000-E	SP	POLYACRYLAMIDE (PAM)	90		LB
0117	6071030000-E	1640	COIR FIBER BAFFLE	70		LF
0118	6071050000-E	SP	*** SKIMMER (1-1/2")	1		EA
0119	6084000000-E	1660	SEEDING & MULCHING	4		ACR
0120	6087000000-E	1660	MOWING	2		ACR
0121	6090000000-E	1661	SEED FOR REPAIR SEEDING	50		LB
0122	6093000000-E	1661	FERTILIZER FOR REPAIR SEEDING	0.25		TON
0123	6096000000-E	1662	SEED FOR SUPPLEMENTAL SEEDING	100		LB
0124	6108000000-E	1665	FERTILIZER TOPDRESSING	2.5		TON
0125	6111000000-E	SP	IMPERVIOUS DIKE	250		LF
0126	6114500000-N	1667	SPECIALIZED HAND MOWING	10		MHR
0127	6117000000-N	SP	RESPONSE FOR EROSION CONTROL	20		EA
0128	6120000000-E	SP	CULVERT DIVERSION CHANNEL	280		CY
0129	6132000000-N	SP	GENERIC EROSION CONTROL ITEM CONCRETE WASHOUT STRUCTURE	6		EA
0130	6890000000-E	SP	CONCRETE STEPS	1		CY
0131	7060000000-E	1705	SIGNAL CABLE	920		LF
0132	7120000000-E	1705	VEHICLE SIGNAL HEAD (12", 3 SECTION)	9		EA
0133	7132000000-E	1705	VEHICLE SIGNAL HEAD (12", 4 SECTION)	1		EA
0134	7264000000-E	1710	MESSENGER CABLE (3/8")	350		LF

County : Union

Line #	Item Number	Sec #	Description	Quantity	Unit Cost	Amount
0135	7288000000-E	1715	PAVED TRENCHING (*****) (2", 1)	25 LF		
0136	7300000000-E	1715	UNPAVED TRENCHING (*****) (2", 1)	700 LF		
0137	7324000000-N	1716	JUNCTION BOX (STANDARD SIZE)	8 EA		
0138	7360000000-N	1720	WOOD POLE	2 EA		
0139	7372000000-N	1721	GUY ASSEMBLY	8 EA		
0140	7408000000-E	1722	1" RISER WITH WEATHERHEAD	1 EA		
0141	7420000000-E	1722	2" RISER WITH WEATHERHEAD	5 EA		
0142	7444000000-E	1725	INDUCTIVE LOOP SAWCUT	700 LF		
0143	7456000000-E	1726	LEAD-IN CABLE (*****) (14-2)	1,675 LF		
0144	7575200000-N	SP	GPS UNIT	2 EA		
0145	7636000000-N	1745	SIGN FOR SIGNALS	8 EA		
0146	7684000000-N	1750	SIGNAL CABINET FOUNDATION	1 EA		
0147	7756000000-N	1751	CONTROLLER WITH CABINET (TYPE 2070L, BASE MOUNTED)	1 EA		
0148	7780000000-N	1751	DETECTOR CARD (TYPE 2070L)	5 EA		
0149	7901000000-N	1753	CABINET BASE EXTENDER	1 EA		
0150	7948000000-N	1757	TRAFFIC SIGNAL REMOVAL	1 EA		
0151	7980000000-N	SP	GENERIC SIGNAL ITEM RELOCATE SCHOOL FLASHER	1 EA		

County : Union

Line #	Item Number	Sec #	Description	Quantity	Unit Cost	Amount
<b>CULVERT ITEMS</b>						
0152	8042000000-N	402	REMOVAL OF EXISTING STRUCTURES AT STATION ***** (19+67.20 -L-)	Lump Sum	L.S.	
0153	8126000000-N	414	CULVERT EXCAVATION, STA ***** (19+67.20 -L-)	Lump Sum	L.S.	
0154	8133000000-E	414	FOUNDATION CONDITIONING MATERIAL, BOX CULVERT	182 TON		
0155	8196000000-E	420	CLASS A CONCRETE (CULVERT)	268.7 CY		
0156	8245000000-E	425	REINFORCING STEEL (CULVERT)	30,621 LB		
0157	8804000000-N	SP	GENERIC CULVERT ITEM PLACEMENT OF NATURAL STREAM BED MATERIAL	Lump Sum	L.S.	

0911/Nov30/Q83696.95/D686031710000/E157

Total Amount Of Bid For Entire Project :



**Vendor 1 of 4: SEALAND CONTRACTORS CORP (3618)**  
**Call Order 009 (Proposal: C203663)**

**Bid Information**

---

**Proposal County:** UNION

**Vendor Address:** P.O. Box 350  
85 High Tech Drive  
Rush , NY , 14543-0350

**Signature Check:** Robert\_J.\_Bree\_3618

**Time Bid Received:** January 19, 2016 01:33 PM

**Amendment Count:** 0

**Bid Checksum:** 23C02AC3

**Bid Total:** \$1,926,671.52

**Items Total:** \$1,926,671.52

**Time Total:** \$0.00

**Bidding Errors:**

None.

DBE Goal Set 11.0

DBE Goal Met 11.0

**Vendor 1 of 4: SEALAND CONTRACTORS CORP (3618)**  
**Call Order 009 (Proposal: C203663)**

**Bid Information**

---

**Proposal County:** UNION

**Vendor Address:** P.O. Box 350  
85 High Tech Drive  
Rush , NY , 14543-0350

**Signature Check:** Robert\_J.\_Bree\_3618

**Time Bid Received:** January 19, 2016 01:33 PM

**Amendment Count:** 0

**Bid Checksum:** 23C02AC3

**Bid Total:** \$1,926,671.52

**Items Total:** \$1,926,671.52

**Time Total:** \$0.00

**Bidding Errors:**

None.

Bidder 1 of 4

Bid Bond Data Info - Contractor Responses:

=====

BondID: SNC15390942

Surety Registry Agency: surety2000

Verified?: Yes

Surety Agency: Liberty Mutual Insurance Company

Bond Execution Date: 12/28/2015 3

Bond Amount: \$96,333.58 (Five Percent of Bid)

Bidder 1 of 4

Vendor 3618's Bid Information for Call 009, Letting L160119, 01/19/16

Sealand Contractors Corp. (3618)  
 Call Order 009 (Proposal ID C203663)

LIST OF DBE PARTICIPANTS

VENDOR NUMBER	DBE NAME ADDRESS	WORK CODE TYPE OF WORK	CERT TYPE AMOUNT
10201WB	D'S TRUCKING SERVICE INC PO BOX 1404 , INDIAN TRAIL, NC 28079		Sub 156,900.00 Committed
3376WB	REYNOLDS FENCE & GUARDRAIL INC 9320 MACHADO DRIVE , INDIAN TRAIL, NC 28079		Sub 10,050.00 Committed
2759WB	SUPERIOR SEEDING, INC. POST OFFICE BOX 12642 , GASTONIA, NC 280520010		Sub 38,044.00 Committed
4761WB	TRAFFIC CONTROL SAFETY SERVICES POST OFFICE BOX 24511 , WINSTON-SALEM, NC 27114		Sub 6,989.00 Committed
TOTAL:			\$211,983.00 11.00%

Vendor 3618's Bid Information for Call 009, Letting L160119, 01/19/16

Sealand Contractors Corp. (3618)  
 Call Order 009 (Proposal ID C203663)

Miscellaneous Data Info - Contractor Responses:

NON-COLLUSION AND DEBARMENT CERTIFICATION

Explanation of the prospective bidder that is unable to certify to any of the statements in this certification:

- Explanation:
- NOT ANSWERED
- NOT ANSWERED
- NOT ANSWERED
- NOT ANSWERED

AWARD LIMITS ON MULTIPLE PROJECTS

By answering YES to this statement, the bidder acknowledges that they are using the award limits on multiple projects. No

It is the desire of the Bidder to be awarded contracts, the value of which will not exceed a total of NOT ANSWERED for those projects indicated herein, for which bids will be opened on (MM/DD/YY)

The Award Limits shall apply to the following projects:

Contract Number	County
NOT ANSWERED	
NOT ANSWERED	
NOT ANSWERED	
NOT ANSWERED	
NOT ANSWERED	
NOT ANSWERED	

Dept of Transportation

Revised:

Contract ID: C203663

Project(s): BRSTP-1008(23)

Letting Date: 01-19-16 Call Order: 009

Bidder: 3618 - Sealand Contractors Corp.

Line No.	Item Description	Approx. Quantity and Units	Unit Price Dollars   Cts	Bid Amount Dollars   Ct
Section 0001 ROADWAY ITEMS				
Alt Group				
0001	0000100000-N MOBILIZATION	LUMP	LUMP	96,000.00
0002	0000400000-N CONSTRUCTION SURVEYING	LUMP	LUMP	10,000.00
0003	0043000000-N GRADING	LUMP	LUMP	356,762.00
0004	0050000000-E SUPPLEMENTARY CLEARING & GRUB-BING	1.000 ACR	10,000.00000	10,000.00
0005	0057000000-E UNDERCUT EXCAVATION	950.000 CY	38.00000	36,100.00
0006	0134000000-E DRAINAGE DITCH EXCAVATION	100.000 CY	17.30000	1,730.00
0007	0195000000-E SELECT GRANULAR MATERIAL	500.000 CY	38.00000	19,000.00
0008	0196000000-E GEOTEXTILE FOR SOIL STABILIZATION	1,300.000 SY	0.65000	845.00
0009	0318000000-E FOUNDATION CONDITIONING MATERIAL, MINOR STRUCTURES	353.000 TON	39.00000	13,767.00
0010	0320000000-E FOUNDATION CONDITIONING GEOTEXTILE	1,110.000 SY	2.85000	3,163.50
0011	0335200000-E 15" DRAINAGE PIPE	136.000 LF	43.00000	5,848.00

Dept of Transportation

Revised:

Contract ID: C203663

Project(s): BRSTP-1008(23)

Letting Date: 01-19-16 Call Order: 009

Bidder: 3618 - Sealand Contractors Corp.

Line No.	Item Description	Approx. Quantity and Units	Unit Price Dollars   Cts	Bid Amount Dollars   Ct
0012	0335300000-E 18" DRAINAGE PIPE	32.000	54.00000	1,728.00
		LF		
0013	0335600000-E 36" DRAINAGE PIPE	44.000	110.00000	4,840.00
		LF		
0014	0335800000-E 48" DRAINAGE PIPE	40.000	145.00000	5,800.00
		LF		
0015	0342000000-E **" SIDE DRAIN PIPE (12")	48.000	43.00000	2,064.00
		LF		
0016	0343000000-E 15" SIDE DRAIN PIPE	64.000	44.00000	2,816.00
		LF		
0017	0366000000-E 15" RC PIPE CULVERTS, CLASS III	652.000	44.00000	28,688.00
		LF		
0018	0372000000-E 18" RC PIPE CULVERTS, CLASS III	40.000	56.00000	2,240.00
		LF		
0019	0390000000-E 36" RC PIPE CULVERTS, CLASS III	28.000	120.00000	3,360.00
		LF		
0020	0995000000-E PIPE REMOVAL	140.000	17.00000	2,380.00
		LF		
0021	1099500000-E SHALLOW UNDERCUT	500.000	17.00000	8,500.00
		CY		
0022	1099700000-E CLASS IV SUBGRADE STABILIZATION	540.000	24.00000	12,960.00
		TON		
0023	1220000000-E INCIDENTAL STONE BASE	150.000	30.00000	4,500.00
		TON		

Dept of Transportation

Revised:

Contract ID: C203663

Project(s): BRSTP-1008(23)

Letting Date: 01-19-16 Call Order: 009

Bidder: 3618 - Sealand Contractors Corp.

Line No.	Item Description	Approx. Quantity and Units	Unit Price Dollars   Cts	Bid Amount Dollars   Ct
0024	1330000000-E INCIDENTAL MILLING	280.000 SY	25.00000	7,000.00
0025	1489000000-E ASPHALT CONC BASE COURSE, TYPE B25.0B	960.000 TON	70.00000	67,200.00
0026	1498000000-E ASPHALT CONC INTERMEDIATE COURSE, TYPE I19.0B	990.000 TON	70.00000	69,300.00
0027	1519000000-E ASPHALT CONC SURFACE COURSE, TYPE S9.5B	1,560.000 TON	71.00000	110,760.00
0028	1575000000-E ASPHALT BINDER FOR PLANT MIX	185.000 TON	470.00000	86,950.00
0029	1693000000-E ASPHALT PLANT MIX, PAVEMENT REPAIR	225.000 TON	175.00000	39,375.00
0030	2000000000-N RIGHT OF WAY MARKERS	39.000 EA	195.00000	7,605.00
0031	2022000000-E SUBDRAIN EXCAVATION	45.000 CY	15.00000	675.00
0032	2026000000-E GEOTEXTILE FOR SUBSURFACE DRAINS	200.000 SY	1.00000	200.00
0033	2036000000-E SUBDRAIN COARSE AGGREGATE	35.000 CY	60.00000	2,100.00
0034	2044000000-E 6" PERFORATED SUBDRAIN PIPE	200.000 LF	8.00000	1,600.00
0035	2077000000-E 6" OUTLET PIPE	6.000 LF	20.00000	120.00



Contract ID: C203663

Project(s): BRSTP-1008(23)

Letting Date: 01-19-16 Call Order: 009

Bidder: 3618 - Sealand Contractors Corp.

Line No.	Item Description	Approx. Quantity and Units	Unit Price Dollars   Cts	Bid Amount Dollars   Ct
0036	2132000000-N CONCRETE PAD FOR SHOULDER DRAIN PIPE OUTLET	1.000 EA	250.00000	250.00
0037	2253000000-E PIPE COLLARS	2.000 CY	900.00000	1,800.00
0038	2275000000-E FLOWABLE FILL	1.000 CY	325.00000	325.00
0039	2286000000-N MASONRY DRAINAGE STRUCTURES	15.000 EA	1,400.00000	21,000.00
0040	2308000000-E MASONRY DRAINAGE STRUCTURES	5.000 LF	245.00000	1,225.00
0041	2364000000-N FRAME WITH TWO GRATES, STD 840.16	2.000 EA	420.00000	840.00
0042	2366000000-N FRAME WITH TWO GRATES, STD 840.24	2.000 EA	500.00000	1,000.00
0043	2374000000-N FRAME WITH GRATE & HOOD, STD 840.03, TYPE ** (E)	4.000 EA	440.00000	1,760.00
0044	2374000000-N FRAME WITH GRATE & HOOD, STD 840.03, TYPE ** (F)	1.000 EA	485.00000	485.00
0045	2374000000-N FRAME WITH GRATE & HOOD, STD 840.03, TYPE ** (G)	5.000 EA	485.00000	2,425.00
0046	2396000000-N FRAME WITH COVER, STD 840.54	1.000 EA	400.00000	400.00
0047	2549000000-E 2'-6" CONCRETE CURB & GUTTER	1,775.000 LF	19.85000	35,233.75

Dept of Transportation

Revised:

Contract ID: C203663

Project(s): BRSTP-1008(23)

Letting Date: 01-19-16 Call Order: 009

Bidder: 3618 - Sealand Contractors Corp.

Line No.	Item Description	Approx. Quantity and Units	Unit Price Dollars   Cts	Bid Amount Dollars   Ct
0048	2591000000-E 4" CONCRETE SIDEWALK	590.000 SY	31.00000	18,290.00
0049	2605000000-N CONCRETE CURB RAMP	6.000 EA	1,100.00000	6,600.00
0050	2612000000-E 6" CONCRETE DRIVEWAY	35.000 SY	55.00000	1,925.00
0051	2655000000-E 5" MONOLITHIC CONCRETE ISLANDS (KEYED IN)	65.000 SY	55.00000	3,575.00
0052	2800000000-N ADJUSTMENT OF CATCH BASINS	1.000 EA	400.00000	400.00
0053	2830000000-N ADJUSTMENT OF MANHOLES	4.000 EA	450.00000	1,800.00
0054	3030000000-E STEEL BM GUARDRAIL	150.000 LF	32.00000	4,800.00
0055	3150000000-N ADDITIONAL GUARDRAIL POSTS	5.000 EA	32.00000	160.00
0056	3210000000-N GUARDRAIL ANCHOR UNITS, TYPE CAT-1	2.000 EA	685.00000	1,370.00
0057	3270000000-N GUARDRAIL ANCHOR UNITS, TYPE 350	2.000 EA	2,155.00000	4,310.00
0058	3575000000-E GENERIC FENCING ITEM VINYL COATED GLARE SCREEN (GUARDRAIL MOUNTED)	50.000 LF	42.00000	2,100.00

Dept of Transportation

Revised:

Contract ID: C203663

Project(s): BRSTP-1008(23)

Letting Date: 01-19-16 Call Order: 009

Bidder: 3618 - Sealand Contractors Corp.

Line No.	Item Description	Approx. Quantity and Units	Unit Price Dollars   Cts	Bid Amount Dollars   Ct
0059	3628000000-E RIP RAP, CLASS I	78.000 TON	55.00000	4,290.00
0060	3635000000-E RIP RAP, CLASS II	10.000 TON	85.00000	850.00
0061	3649000000-E RIP RAP, CLASS B	10.000 TON	65.00000	650.00
0062	3656000000-E GEOTEXTILE FOR DRAINAGE	813.000 SY	1.50000	1,219.50
0063	4072000000-E SUPPORTS, 3-LB STEEL U-CHANNEL	275.000 LF	5.75000	1,581.25
0064	4102000000-N SIGN ERECTION, TYPE E	19.000 EA	58.00000	1,102.00
0065	4155000000-N DISPOSAL OF SIGN SYSTEM, U-CHANNEL	11.000 EA	1.00000	11.00
0066	4400000000-E WORK ZONE SIGNS (STATIONARY)	582.000 SF	4.85000	2,822.70
0067	4405000000-E WORK ZONE SIGNS (PORTABLE)	144.000 SF	16.00000	2,304.00
0068	4410000000-E WORK ZONE SIGNS (BARRICADE MOUNTED)	123.000 SF	5.60000	688.80
0069	4430000000-N DRUMS	54.000 EA	50.00000	2,700.00
0070	4435000000-N CONES	37.000 EA	20.00000	740.00

Dept of Transportation

Revised:

Contract ID: C203663

Project(s): BRSTP-1008(23)

Letting Date: 01-19-16 Call Order: 009

Bidder: 3618 - Sealand Contractors Corp.

Line No.	Item Description	Approx. Quantity and Units	Unit Price Dollars   Cts	Bid Amount Dollars   Ct
0071	4445000000-E BARRICADES (TYPE III)	96.000	17.75000	1,704.00
		LF		
0072	4455000000-N FLAGGER	180.000	200.00000	36,000.00
		DAY		
0073	4650000000-N TEMPORARY RAISED PAVEMENT MARKERS	45.000	6.20000	279.00
		EA		
0074	4685000000-E THERMOPLASTIC PAVEMENT MARKING LINES (4", 90 MILS)	2,293.000	0.70000	1,605.10
		LF		
0075	4686000000-E THERMOPLASTIC PAVEMENT MARKING LINES (4", 120 MILS)	5,085.000	0.73000	3,712.05
		LF		
0076	4695000000-E THERMOPLASTIC PAVEMENT MARKING LINES (8", 90 MILS)	180.000	1.46000	262.80
		LF		
0077	4710000000-E THERMOPLASTIC PAVEMENT MARKING LINES (24", 120 MILS)	132.000	6.51000	859.32
		LF		
0078	4721000000-E THERMOPLASTIC PAVEMENT MARKING CHARACTER (120 MILS)	6.000	103.00000	618.00
		EA		
0079	4725000000-E THERMOPLASTIC PAVEMENT MARKING SYMBOL (90 MILS)	8.000	103.00000	824.00
		EA		
0080	4810000000-E PAINT PAVEMENT MARKING LINES (4")	7,193.000	0.23000	1,654.39
		LF		
0081	4820000000-E PAINT PAVEMENT MARKING LINES (8")	32.000	1.26000	40.32
		LF		

Dept of Transportation

Revised:

Contract ID: C203663

Project(s): BRSTP-1008(23)

Letting Date: 01-19-16 Call Order: 009

Bidder: 3618 - Sealand Contractors Corp.

Line No.	Item Description	Approx. Quantity and Units	Unit Price Dollars   Cts	Bid Amount Dollars   Ct
0082	4835000000-E PAINT PAVEMENT MARKING LINES (24")	174.000 LF	3.26000	567.24
0083	4845000000-N PAINT PAVEMENT MARKING SYMBOL	8.000 EA	42.00000	336.00
0084	4900000000-N PERMANENT RAISED PAVEMENT MARKERS	33.000 EA	6.60000	217.80
0085	5325600000-E 6" WATER LINE	1,138.000 LF	68.00000	77,384.00
0086	5325800000-E 8" WATER LINE	686.000 LF	78.00000	53,508.00
0087	5540000000-E 6" VALVE	5.000 EA	1,050.00000	5,250.00
0088	5546000000-E 8" VALVE	2.000 EA	1,450.00000	2,900.00
0089	5648000000-N RELOCATE WATER METER	9.000 EA	1,285.00000	11,565.00
0090	5649000000-N RECONNECT WATER METER	5.000 EA	1,025.00000	5,125.00
0091	5672000000-N RELOCATE FIRE HYDRANT	2.000 EA	3,100.00000	6,200.00
0092	5691300000-E 8" SANITARY GRAVITY SEWER	393.000 LF	85.00000	33,405.00
0093	5775000000-E 4' DIA UTILITY MANHOLE	3.000 EA	3,500.00000	10,500.00

Dept of Transportation

Revised:

Contract ID: C203663

Project(s): BRSTP-1008(23)

Letting Date: 01-19-16 Call Order: 009

Bidder: 3618 - Sealand Contractors Corp.

Line No.	Item Description	Approx. Quantity and Units	Unit Price Dollars   Cts	Bid Amount Dollars   Ct
0094	5781000000-E UTILITY MANHOLE WALL, 4' DIA	13.000 LF	200.00000	2,600.00
0095	5800000000-E ABANDON 6" UTILITY PIPE	1,010.000 LF	9.25000	9,342.50
0096	5801000000-E ABANDON 8" UTILITY PIPE	1,034.000 LF	12.25000	12,666.50
0097	5816000000-N ABANDON UTILITY MANHOLE	1.000 EA	710.00000	710.00
0098	5828000000-N REMOVE UTILITY MANHOLE	2.000 EA	675.00000	1,350.00
0099	5835600000-E 12" ENCASEMENT PIPE	60.000 LF	100.00000	6,000.00
0100	6000000000-E TEMPORARY SILT FENCE	2,860.000 LF	2.10000	6,006.00
0101	6006000000-E STONE FOR EROSION CONTROL, CLASS A	285.000 TON	52.00000	14,820.00
0102	6009000000-E STONE FOR EROSION CONTROL, CLASS B	160.000 TON	52.00000	8,320.00
0103	6012000000-E SEDIMENT CONTROL STONE	390.000 TON	45.00000	17,550.00
0104	6015000000-E TEMPORARY MULCHING	4.000 ACR	1,050.00000	4,200.00
0105	6018000000-E SEED FOR TEMPORARY SEEDING	300.000 LB	6.30000	1,890.00

Dept of Transportation

Revised:

Contract ID: C203663

Project(s): BRSTP-1008(23)

Letting Date: 01-19-16 Call Order: 009

Bidder: 3618 - Sealand Contractors Corp.

Line No.	Item Description	Approx. Quantity and Units	Unit Price Dollars   Cts	Bid Amount Dollars   Ct
0106	6021000000-E FERTILIZER FOR TEMPORARY SEED-ING	2.500 TON	2,100.00000	5,250.00
0107	6024000000-E TEMPORARY SLOPE DRAINS	200.000 LF	13.50000	2,700.00
0108	6029000000-E SAFETY FENCE	200.000 LF	2.00000	400.00
0109	6030000000-E SILT EXCAVATION	400.000 CY	16.00000	6,400.00
0110	6036000000-E MATTING FOR EROSION CONTROL	5,000.000 SY	1.84000	9,200.00
0111	6037000000-E COIR FIBER MAT	100.000 SY	4.15000	415.00
0112	6038000000-E PERMANENT SOIL REINFORCEMENT MAT	120.000 SY	4.15000	498.00
0113	6042000000-E 1/4" HARDWARE CLOTH	850.000 LF	4.10000	3,485.00
0114	6070000000-N SPECIAL STILLING BASINS	6.000 EA	370.00000	2,220.00
0115	6071010000-E WATTLE	270.000 LF	6.20000	1,674.00
0116	6071020000-E POLYACRYLAMIDE (PAM)	90.000 LB	8.00000	720.00
0117	6071030000-E COIR FIBER BAFFLE	70.000 LF	7.50000	525.00

Dept of Transportation

Revised:

Contract ID: C203663

Project(s): BRSTP-1008(23)

Letting Date: 01-19-16 Call Order: 009

Bidder: 3618 - Sealand Contractors Corp.

Line No.	Item Description	Approx. Quantity and Units	Unit Price Dollars   Cts	Bid Amount Dollars   Ct
0118	6071050000-E *** SKIMMER (1-1/2")	1.000 EA	1,225.00000	1,225.00
0119	6084000000-E SEEDING & MULCHING	4.000 ACR	1,835.00000	7,340.00
0120	6087000000-E MOWING	2.000 ACR	155.00000	310.00
0121	6090000000-E SEED FOR REPAIR SEEDING	50.000 LB	7.35000	367.50
0122	6093000000-E FERTILIZER FOR REPAIR SEEDING	0.250 TON	2,625.00000	656.25
0123	6096000000-E SEED FOR SUPPLEMENTAL SEEDING	100.000 LB	5.25000	525.00
0124	6108000000-E FERTILIZER TOPDRESSING	2.500 TON	1,470.00000	3,675.00
0125	6111000000-E IMPERVIOUS DIKE	250.000 LF	26.00000	6,500.00
0126	6114500000-N SPECIALIZED HAND MOWING	10.000 MHR	37.00000	370.00
0127	6117000000-N RESPONSE FOR EROSION CONTROL	20.000 EA	260.00000	5,200.00
0128	6120000000-E CULVERT DIVERSION CHANNEL	280.000 CY	37.00000	10,360.00



Dept of Transportation

Revised:

Contract ID: C203663

Project(s): BRSTP-1008(23)

Letting Date: 01-19-16 Call Order: 009

Bidder: 3618 - Sealand Contractors Corp.

Line No.	Item Description	Approx. Quantity and Units	Unit Price Dollars   Cts	Bid Amount Dollars   Ct
0129	6132000000-N GENERIC EROSION CONTROL ITEM CONCRETE WASHOUT STRUCTURE	6.000 EA	1,900.00000	11,400.00
0130	6890000000-E CONCRETE STEPS	1.000 CY	850.00000	850.00
0131	7060000000-E SIGNAL CABLE	920.000 LF	2.36000	2,171.20
0132	7120000000-E VEHICLE SIGNAL HEAD (12", 3 SECTION)	9.000 EA	840.00000	7,560.00
0133	7132000000-E VEHICLE SIGNAL HEAD (12", 4 SECTION)	1.000 EA	1,050.00000	1,050.00
0134	7264000000-E MESSENGER CABLE (3/8")	350.000 LF	3.15000	1,102.50
0135	7288000000-E PAVED TRENCHING (*****)(2", 1)	25.000 LF	31.50000	787.50
0136	7300000000-E UNPAVED TRENCHING (*****)(2", 1)	700.000 LF	6.30000	4,410.00
0137	7324000000-N JUNCTION BOX (STANDARD SIZE)	8.000 EA	315.00000	2,520.00
0138	7360000000-N WOOD POLE	2.000 EA	950.00000	1,900.00
0139	7372000000-N GUY ASSEMBLY	8.000 EA	370.00000	2,960.00

Dept of Transportation

Revised:

Contract ID: C203663

Project(s): BRSTP-1008(23)

Letting Date: 01-19-16 Call Order: 009

Bidder: 3618 - Sealand Contractors Corp.

Line No.	Item Description	Approx. Quantity and Units	Unit Price Dollars   Cts	Bid Amount Dollars   Ct
0140	7408000000-E 1" RISER WITH WEATHERHEAD	1.000 EA	315.00000	315.00
0141	7420000000-E 2" RISER WITH WEATHERHEAD	5.000 EA	475.00000	2,375.00
0142	7444000000-E INDUCTIVE LOOP SAWCUT	700.000 LF	7.35000	5,145.00
0143	7456000000-E LEAD-IN CABLE (*****)(14-2)	1,675.000 LF	1.58000	2,646.50
0144	7575200000-N GPS UNIT	2.000 EA	1,160.00000	2,320.00
0145	7636000000-N SIGN FOR SIGNALS	8.000 EA	420.00000	3,360.00
0146	7684000000-N SIGNAL CABINET FOUNDATION	1.000 EA	630.00000	630.00
0147	7756000000-N CONTROLLER WITH CABINET (TYPE 2070L, BASE MOUNTED)	1.000 EA	11,100.00000	11,100.00
0148	7780000000-N DETECTOR CARD (TYPE 2070L)	5.000 EA	105.00000	525.00
0149	7901000000-N CABINET BASE EXTENDER	1.000 EA	420.00000	420.00
0150	7948000000-N TRAFFIC SIGNAL REMOVAL	1.000 EA	1,900.00000	1,900.00
0151	7980000000-N GENERIC SIGNAL ITEM RELOCATE SCHOOL FLASHER	1.000 EA	2,100.00000	2,100.00

Contract ID: C203663

Project(s): BRSTP-1008(23)

Letting Date: 01-19-16 Call Order: 009

Bidder: 3618 - Sealand Contractors Corp.

Line No.	Item Description	Approx. Quantity and Units	Unit Price Dollars   Cts	Bid Amount Dollars   Ct
Section 0001 Total				1,636,544.97
Section 0002 CULVERT ITEMS				
Alt Group				
0152	8042000000-N REMOVAL OF EXISTING STRUCTURES AT STATION ***** (19+67.20 -L-)	LUMP	LUMP	55,000.00
0153	8126000000-N CULVERT EXCAVATION, STA ***** (19+67.20 -L-)	LUMP	LUMP	35,000.00
0154	8133000000-E FOUNDATION CONDITIONING MATERIAL, BOX CULVERT	182.000 TON	53.00000	9,646.00
0155	8196000000-E CLASS A CONCRETE (CULVERT)	268.700 CY	555.00000	149,128.50
0156	8245000000-E REINFORCING STEEL (CULVERT)	30,621.000 LB	1.05000	32,152.05
0157	8804000000-N GENERIC CULVERT ITEM PLACEMENT OF NATURAL STREAM BED MATERIAL	LUMP	LUMP	9,200.00
Section 0002 Total				290,126.55
Bid Total				1,926,671.52

NON-COLLUSION AND DEBARMENT CERTIFICATION

The bidder certifies that neither he, nor any official, agent or employee of the bidder has entered into any agreement, participated in any collusion, or otherwise taken any action which is in restraint of free competitive bidding in connection with this bid, and that the bidder intends to do the work with its own bonafide employees or subcontractors and is not bidding for the benefit of another contractor. In addition, submitting this electronic bid constitutes the bidder's certification of Status under penalty of perjury under the laws of the United States and in accordance with the Debarment Certification on file with the Department.

By submitting this bid, the bidder certifies to the best of his knowledge and belief that he and his principals:

- a. Are not presently debarred, suspended, proposed for debarment, declared ineligible, or voluntarily excluded from covered transactions by any Federal department or agency;
- b. Have not within a three-year period preceding this proposal been convicted of or had a civil judgment rendered against them for commission of fraud or a criminal offense in connection with obtaining, attempting to obtain, or performing a public (Federal, State or local) transaction or contract under a public transaction; violation of Federal or State antitrust statutes or commission of embezzlement, theft, forgery, bribery, falsification or destruction of records; making false statements; or receiving stolen property;
- c. Are not presently indicted for or otherwise criminally or civilly charged by a governmental entity (Federal, State or local) with commission of any of the offenses enumerated in paragraph b. of this certification; and
- d. Have not within a three-year period preceding this proposal had one or more public transactions (Federal, State or local) terminated for cause or default.

Where the prospective bidder is unable to certify to any of the statements in this certification, the bidder shall submit an explanation in the blanks provided herein. The explanation will not necessarily result in denial of participation in a contract.

Explanation:  
NOT ANSWERED  
NOT ANSWERED  
NOT ANSWERED  
NOT ANSWERED

If the prequalified bidder's status changes, he shall immediately submit a new fully executed non-collusion affidavit and debarment certification with an explanation of the change to the Contract Office prior to submitting the bid.

Failure to furnish a certification or an explanation will be grounds for rejection of a bid

AWARD LIMITS ON MULTIPLE PROJECTS

By answering YES to this statement, the bidder acknowledges that they are using the award limits on multiple projects. No

A bidder who desires to bid on more than one project on which bids are to be opened on the same date, and who also desires to avoid receiving an award of more projects than he is equipped to handle, may bid on any number of projects but may limit the total amount of work awarded to him on selected projects by completing the AWARD LIMITS ON MULTIPLE PROJECTS.

The Award Limits on Multiple Projects must be filled in on each project bid for which the Bidder desires protection.

It is the desire of the Bidder to be awarded contracts, the value of which will not exceed a total of NOT ANSWERED for those projects indicated herein, for which bids will be opened on (MM/DD/YY)

The Award Limits shall apply to the following projects:

Contract Number	County
NOT ANSWERED	
NOT ANSWERED	
NOT ANSWERED	
NOT ANSWERED	
NOT ANSWERED	
NOT ANSWERED	

It is agreed that if I am (we are) the low Bidder(s) on indicated projects, the total value of which is more than the above stipulated award limits, the Board of Transportation will award me (us) projects from among those indicated that have a total value not to exceed the award limit and will result in the lowest total bids to the Department of Transportation.

PROPOSAL: C203663  
 LETTING: L160119 CALL: 009  
 VENDOR: 3618 Sealand Contractors Corp.

LINE NO.	ITEM NO.	ITEM DESC.	UNIT TYPE	SUBCONTRACTOR QUANTITY	SUBCONTRACTOR UNIT PRICE	EXTENDED AMOUNT
-----						
DBE SUBCONTRACTOR: 10201 D'S TRUCKING SERVICE INC						
Will Use Quote: Yes						
0003	0043000000-N	GRADING	LS	1.000	64740.00000	64740.00
		1079 Hrs. x \$60.00/Hr.				
0005	0057000000-E	UNDERCUT EXC	CY	310.000	60.00000	18600.00
		310 Hrs. x \$60.00/Hr.				
0006	0134000000-E	DRAINAGE DIT	CY	13.500	60.00000	810.00
		13.5 Hrs. x \$60.00/Hr.				
0009	0318000000-E	FND CONDIT M	TON	38.000	60.00000	2280.00
		38 Hrs. x \$60.00/Hr.				
0011	0335200000-E	15" DRAINAGE	LF	12.000	60.00000	720.00
		12 Hrs. x \$60.00/Hr.				
0012	0335300000-E	18" DRAINAGE	LF	3.500	60.00000	210.00
		3.5 Hrs. x \$60.00/Hr.				
0013	0335600000-E	36" DRAINAGE	LF	5.500	60.00000	330.00
		5.5 Hrs. x \$60.00/Hr.				
0014	0335800000-E	48" DRAINAGE	LF	8.000	60.00000	480.00
		8 Hrs. x \$60.00/Hr.				
0015	0342000000-E	**" SIDE DRA	LF	4.000	60.00000	240.00
		4 Hrs. x \$60.00/Hr.				
0016	0343000000-E	15" SIDE DRA	LF	5.500	60.00000	330.00
		5.5 Hrs. x \$60.00/Hr.				
0017	0366000000-E	15" RC PIPE	LF	54.000	60.00000	3240.00
		54 Hrs. x \$60.00/Hr.				
0018	0372000000-E	18" RC PIPE	LF	4.500	60.00000	270.00
		4.5 Hrs. x \$60.00/Hr.				
0019	0390000000-E	36" RC PIPE	LF	4.500	60.00000	270.00
		4.5 Hrs. x \$60.00/Hr.				
0020	0995000000-E	PIPE REMOVAL	LF	13.000	60.00000	780.00
		13 Hrs. x \$60.00/Hr.				
0021	1099500000-E	SHALLOW UNDE	CY	81.000	60.00000	4860.00
		81 Hrs. x \$60.00/Hr.				
0024	1330000000-E	INCIDENTAL M	SY	10.500	60.00000	630.00
		10.5 Hrs. x \$60.00/Hr.				
0025	1489000000-E	ASP CONC BAS	TON	172.000	60.00000	10320.00
		172 Hrs. x \$60.00/Hr.				
0026	1498000000-E	ASP CONC INT	TON	166.000	60.00000	9960.00
		166 Hrs. x \$60.00/Hr.				
0027	1519000000-E	ASP CONC SUR	TON	194.000	60.00000	11640.00
		194 Hrs. x \$60.00/Hr.				
0029	1693000000-E	ASPH PLT MIX	TON	97.000	60.00000	5820.00
		97 Hrs. x \$60.00/Hr.				
0031	2022000000-E	SUBDRAIN EXC	CY	8.500	60.00000	510.00
		8.5 Hrs. x \$60.00/Hr.				
0033	2036000000-E	SUBDRAIN COA	CY	6.000	60.00000	360.00
		6 Hrs. x \$60.00/Hr.				
-----						

PROPOSAL: C203663  
 LETTING: L160119 CALL: 009  
 VENDOR: 3618 Sealand Contractors Corp.

LINE NO.	ITEM NO.	ITEM DESC.	UNIT TYPE	SUBCONTRACTOR QUANTITY	SUBCONTRACTOR UNIT PRICE	EXTENDED AMOUNT
0085	5325600000-E	6" WATER LIN	LF	145.000	60.00000	8700.00
		145 Hrs. x \$60.00/Hr.				
0086	5325800000-E	8" WATER LIN	LF	89.000	60.00000	5340.00
		89 Hrs. x \$60.00/Hr.				
0092	5691300000-E	8" SANITARY	LF	91.000	60.00000	5460.00
		91 Hrs. x \$60.00/Hr.				

DBE COMMITMENT TOTAL FOR SUBCONTRACTOR: 156,900.00 **Committed**  
 DBE COMMITMENT TOTAL FOR VENDOR (SubContractor ) 156,900

DBE SUBCONTRACTOR: 3376 REYNOLDS FENCE & GUARDRAIL INC  
 Will Use Quote: Yes

0054	3030000000-E	STL BM GUARD	LF	150.000	30.00000	4500.00
0055	3150000000-N	ADDIT GUARDR	EA	5.000	30.00000	150.00
0056	3210000000-N	GR ANCHOR TY	EA	2.000	650.00000	1300.00
0057	3270000000-N	GR ANCHOR TY	EA	2.000	2050.00000	4100.00

DBE COMMITMENT TOTAL FOR SUBCONTRACTOR: 10,050.00 **Committed**  
 DBE COMMITMENT TOTAL FOR VENDOR (SubContractor ) 10,050.

DBE SUBCONTRACTOR: 2759 SUPERIOR SEEDING, INC.  
 Will Use Quote: Yes

0104	6015000000-E	TEMPORARY MU	ACR	4.000	1000.00000	4000.00
0105	6018000000-E	SEED FOR TEM	LB	300.000	6.00000	1800.00
0106	6021000000-E	FERT FOR TEM	TON	2.500	2000.00000	5000.00
0110	6036000000-E	MATTING FOR	SY	5000.000	1.75000	8750.00
0111	6037000000-E	COIR FIBER M	SY	100.000	3.95000	395.00
0112	6038000000-E	PERM SOIL RE	SY	120.000	3.95000	474.00
0119	6084000000-E	SEEDING AND	ACR	4.000	1750.00000	7000.00
0120	6087000000-E	MOWING	ACR	2.000	150.00000	300.00
0121	6090000000-E	SEED FOR REP	LB	50.000	7.00000	350.00
0122	6093000000-E	FERT FOR REP	TON	0.250	2500.00000	625.00
0123	6096000000-E	SEED FOR SUP	LB	100.000	5.00000	500.00
0124	6108000000-E	FERTILIZER T	TON	2.500	1400.00000	3500.00
0126	6114500000-N	SPECIALIZED	MHR	10.000	35.00000	350.00
0127	6117000000-N	RESPONSE FOR	EA	20.000	250.00000	5000.00

DBE COMMITMENT TOTAL FOR SUBCONTRACTOR: 38,044.00 **Committed**  
 DBE COMMITMENT TOTAL FOR VENDOR (SubContractor ) 38,044.

DBE SUBCONTRACTOR: 4761 TRAFFIC CONTROL SAFETY SERVICES, INC.  
 Will Use Quote: Yes

0063	4072000000-E	SUPPORT, 3-L	LF	275.000	5.50000	1512.50
0064	4102000000-N	SIGN ERECTIO	EA	19.000	55.00000	1045.00

LINE NO.	ITEM NO.	ITEM DESC.	UNIT TYPE	SUBCONTRACTOR QUANTITY	SUBCONTRACTOR UNIT PRICE	EXTENDED AMOUNT
0065	4155000000-N	DISPOSE SIGN	EA	11.000	1.00000	11.00
0066	4400000000-E	WORK ZONE	SI SF	582.000	4.33000	2520.06
0068	4410000000-E	WORK ZONE	SI SF	123.000	5.00000	615.00
0071	4445000000-E	BARRICADES ( LF		96.000	13.39000	1285.44

DBE COMMITMENT TOTAL FOR SUBCONTRACTOR: 6,989.00 **Committed**  
 DBE COMMITMENT TOTAL FOR VENDOR (SubContractor ) 6,989.0

TOTAL DBE COMMITMENT FOR VENDOR: Entered: 11.00% or 211983.00  
 Required: 11.00% or 211933.87  
 <GOAL MET>



THIS PROPOSAL CONTAINS THE FOLLOWING ERRORS/WARNINGS (IF ANY)

This Bid contains 0 amendment files

Electronic Bid Submission

By submitting this bid electronically, I hereby acknowledge that all requirements included in the hard copy proposal, addendum, amendments, plans, standard specifications, supplemental specifications and special provisions are part of the bid and contract. Further, I acknowledge that I have read, understand, accept, acknowledge and agree to comply with all statements in this electronic bid.

I Hereby certify that I have the authority to submit this bid.

Signature

Agency

Date

-----  
-----  
-----

## Contract Item Sheets For C203663

Line #	ItemNumber	Sec #	Description	Quantity Unit	Unit Bid Price	Amount Bid
<b>ROADWAY ITEMS</b>						
0001	0000100000-N	800	MOBILIZATION	Lump Sum LS	96,000.00	96,000.00
0002	0000400000-N	801	CONSTRUCTION SURVEYING	Lump Sum LS	10,000.00	10,000.00
0003	0043000000-N	226	GRADING	Lump Sum LS	356,762.00	356,762.00
0004	0050000000-E	226	SUPPLEMENTARY CLEARING & GRUB- BING	1 ACR	10,000.00	10,000.00
0005	0057000000-E	226	UNDERCUT EXCAVATION	950 CY	38.00	36,100.00
0006	0134000000-E	240	DRAINAGE DITCH EXCAVATION	100 CY	17.30	1,730.00
0007	0195000000-E	265	SELECT GRANULAR MATERIAL	500 CY	38.00	19,000.00
0008	0196000000-E	270	GEOTEXTILE FOR SOIL STABILIZA- TION	1,300 SY	0.65	845.00
0009	0318000000-E	300	FOUNDATION CONDITIONING MATE- RIAL, MINOR STRUCTURES	353 TON	39.00	13,767.00
0010	0320000000-E	300	FOUNDATION CONDITIONING GEO- TEXTILE	1,110 SY	2.85	3,163.50
0011	0335200000-E	305	15" DRAINAGE PIPE	136 LF	43.00	5,848.00
0012	0335300000-E	305	18" DRAINAGE PIPE	32 LF	54.00	1,728.00
0013	0335600000-E	305	36" DRAINAGE PIPE	44 LF	110.00	4,840.00
0014	0335800000-E	305	48" DRAINAGE PIPE	40 LF	145.00	5,800.00
0015	0342000000-E	310	*** SIDE DRAIN PIPE (12")	48 LF	43.00	2,064.00
0016	0343000000-E	310	15" SIDE DRAIN PIPE	64 LF	44.00	2,816.00
0017	0366000000-E	310	15" RC PIPE CULVERTS, CLASS III	652 LF	44.00	28,688.00
0018	0372000000-E	310	18" RC PIPE CULVERTS, CLASS III	40 LF	56.00	2,240.00
0019	0390000000-E	310	36" RC PIPE CULVERTS, CLASS III	28 LF	120.00	3,360.00

Line #	ItemNumber	Sec #	Description	Quantity Unit	Unit Bid Price	Amount Bid
0020	0995000000-E	340	PIPE REMOVAL	140 LF	17.00	2,380.00
0021	1099500000-E	505	SHALLOW UNDERCUT	500 CY	17.00	8,500.00
0022	1099700000-E	505	CLASS IV SUBGRADE STABILIZATION	540 TON	24.00	12,960.00
0023	1220000000-E	545	INCIDENTAL STONE BASE	150 TON	30.00	4,500.00
0024	1330000000-E	607	INCIDENTAL MILLING	280 SY	25.00	7,000.00
0025	1489000000-E	610	ASPHALT CONC BASE COURSE, TYPE B25.0B	960 TON	70.00	67,200.00
0026	1498000000-E	610	ASPHALT CONC INTERMEDIATE COURSE, TYPE I19.0B	990 TON	70.00	69,300.00
0027	1519000000-E	610	ASPHALT CONC SURFACE COURSE, TYPE S9.5B	1,560 TON	71.00	110,760.00
0028	1575000000-E	620	ASPHALT BINDER FOR PLANT MIX	185 TON	470.00	86,950.00
0029	1693000000-E	654	ASPHALT PLANT MIX, PAVEMENT REPAIR	225 TON	175.00	39,375.00
0030	2000000000-N	806	RIGHT OF WAY MARKERS	39 EA	195.00	7,605.00
0031	2022000000-E	815	SUBDRAIN EXCAVATION	45 CY	15.00	675.00
0032	2026000000-E	815	GEOTEXTILE FOR SUBSURFACE DRAINS	200 SY	1.00	200.00
0033	2036000000-E	815	SUBDRAIN COARSE AGGREGATE	35 CY	60.00	2,100.00
0034	2044000000-E	815	6" PERFORATED SUBDRAIN PIPE	200 LF	8.00	1,600.00
0035	2077000000-E	815	6" OUTLET PIPE	6 LF	20.00	120.00
0036	2132000000-N	816	CONCRETE PAD FOR SHOULDER DRAIN PIPE OUTLET	1 EA	250.00	250.00
0037	2253000000-E	840	PIPE COLLARS	2 CY	900.00	1,800.00
0038	2275000000-E	SP	FLOWABLE FILL	1 CY	325.00	325.00

Line #	ItemNumber	Sec #	Description	Quantity Unit	Unit Bid Price	Amount Bid
0039	2286000000-N	840	MASONRY DRAINAGE STRUCTURES	15 EA	1,400.00	21,000.00
0040	2308000000-E	840	MASONRY DRAINAGE STRUCTURES	5 LF	245.00	1,225.00
0041	2364000000-N	840	FRAME WITH TWO GRATES, STD 840.16	2 EA	420.00	840.00
0042	2366000000-N	840	FRAME WITH TWO GRATES, STD 840.24	2 EA	500.00	1,000.00
0043	2374000000-N	840	FRAME WITH GRATE & HOOD, STD 840.03, TYPE ** (E)	4 EA	440.00	1,760.00
0044	2374000000-N	840	FRAME WITH GRATE & HOOD, STD 840.03, TYPE ** (F)	1 EA	485.00	485.00
0045	2374000000-N	840	FRAME WITH GRATE & HOOD, STD 840.03, TYPE ** (G)	5 EA	485.00	2,425.00
0046	2396000000-N	840	FRAME WITH COVER, STD 840.54	1 EA	400.00	400.00
0047	2549000000-E	846	2'-6" CONCRETE CURB & GUTTER	1,775 LF	19.85	35,233.75
0048	2591000000-E	848	4" CONCRETE SIDEWALK	590 SY	31.00	18,290.00
0049	2605000000-N	848	CONCRETE CURB RAMP	6 EA	1,100.00	6,600.00
0050	2612000000-E	848	6" CONCRETE DRIVEWAY	35 SY	55.00	1,925.00
0051	2655000000-E	852	5" MONOLITHIC CONCRETE ISLANDS (KEYED IN)	65 SY	55.00	3,575.00
0052	2800000000-N	858	ADJUSTMENT OF CATCH BASINS	1 EA	400.00	400.00
0053	2830000000-N	858	ADJUSTMENT OF MANHOLES	4 EA	450.00	1,800.00
0054	3030000000-E	862	STEEL BM GUARDRAIL	150 LF	32.00	4,800.00
0055	3150000000-N	862	ADDITIONAL GUARDRAIL POSTS	5 EA	32.00	160.00
0056	3210000000-N	862	GUARDRAIL ANCHOR UNITS, TYPE CAT-1	2 EA	685.00	1,370.00

Line #	ItemNumber	Sec #	Description	Quantity Unit	Unit Bid Price	Amount Bid
0057	3270000000-N	SP	GUARDRAIL ANCHOR UNITS, TYPE 350	2 EA	2,155.00	4,310.00
0058	3575000000-E	SP	GENERIC FENCING ITEM VINYL COATED GLARE SCREEN (GUARDRAIL MOUNTED)	50 LF	42.00	2,100.00
0059	3628000000-E	876	RIP RAP, CLASS I	78 TON	55.00	4,290.00
0060	3635000000-E	876	RIP RAP, CLASS II	10 TON	85.00	850.00
0061	3649000000-E	876	RIP RAP, CLASS B	10 TON	65.00	650.00
0062	3656000000-E	876	GEOTEXTILE FOR DRAINAGE	813 SY	1.50	1,219.50
0063	4072000000-E	903	SUPPORTS, 3-LB STEEL U-CHANNEL	275 LF	5.75	1,581.25
0064	4102000000-N	904	SIGN ERECTION, TYPE E	19 EA	58.00	1,102.00
0065	4155000000-N	907	DISPOSAL OF SIGN SYSTEM, U-CHANNEL	11 EA	1.00	11.00
0066	4400000000-E	1110	WORK ZONE SIGNS (STATIONARY)	582 SF	4.85	2,822.70
0067	4405000000-E	1110	WORK ZONE SIGNS (PORTABLE)	144 SF	16.00	2,304.00
0068	4410000000-E	1110	WORK ZONE SIGNS (BARRICADE MOUNTED)	123 SF	5.60	688.80
0069	4430000000-N	1130	DRUMS	54 EA	50.00	2,700.00
0070	4435000000-N	1135	CONES	37 EA	20.00	740.00
0071	4445000000-E	1145	BARRICADES (TYPE III)	96 LF	17.75	1,704.00
0072	4455000000-N	1150	FLAGGER	180 DAY	200.00	36,000.00
0073	4650000000-N	1251	TEMPORARY RAISED PAVEMENT MARKERS	45 EA	6.20	279.00
0074	4685000000-E	1205	THERMOPLASTIC PAVEMENT MARKING LINES (4", 90 MILS)	2,293 LF	0.70	1,605.10
0075	4686000000-E	1205	THERMOPLASTIC PAVEMENT MARKING LINES (4", 120 MILS)	5,085 LF	0.73	3,712.05

Line #	ItemNumber	Sec #	Description	Quantity Unit	Unit Bid Price	Amount Bid
0076	4695000000-E	1205	THERMOPLASTIC PAVEMENT MARKING LINES (8", 90 MILS)	180 LF	1.46	262.80
0077	4710000000-E	1205	THERMOPLASTIC PAVEMENT MARKING LINES (24", 120 MILS)	132 LF	6.51	859.32
0078	4721000000-E	1205	THERMOPLASTIC PAVEMENT MARKING CHARACTER (120 MILS)	6 EA	103.00	618.00
0079	4725000000-E	1205	THERMOPLASTIC PAVEMENT MARKING SYMBOL (90 MILS)	8 EA	103.00	824.00
0080	4810000000-E	1205	PAINT PAVEMENT MARKING LINES (4")	7,193 LF	0.23	1,654.39
0081	4820000000-E	1205	PAINT PAVEMENT MARKING LINES (8")	32 LF	1.26	40.32
0082	4835000000-E	1205	PAINT PAVEMENT MARKING LINES (24")	174 LF	3.26	567.24
0083	4845000000-N	1205	PAINT PAVEMENT MARKING SYMBOL	8 EA	42.00	336.00
0084	4900000000-N	1251	PERMANENT RAISED PAVEMENT MARKERS	33 EA	6.60	217.80
0085	5325600000-E	1510	6" WATER LINE	1,138 LF	68.00	77,384.00
0086	5325800000-E	1510	8" WATER LINE	686 LF	78.00	53,508.00
0087	5540000000-E	1515	6" VALVE	5 EA	1,050.00	5,250.00
0088	5546000000-E	1515	8" VALVE	2 EA	1,450.00	2,900.00
0089	5648000000-N	1515	RELOCATE WATER METER	9 EA	1,285.00	11,565.00
0090	5649000000-N	1515	RECONNECT WATER METER	5 EA	1,025.00	5,125.00
0091	5672000000-N	1515	RELOCATE FIRE HYDRANT	2 EA	3,100.00	6,200.00
0092	5691300000-E	1520	8" SANITARY GRAVITY SEWER	393 LF	85.00	33,405.00
0093	5775000000-E	1525	4' DIA UTILITY MANHOLE	3 EA	3,500.00	10,500.00
0094	5781000000-E	1525	UTILITY MANHOLE WALL, 4' DIA	13 LF	200.00	2,600.00

Line #	ItemNumber	Sec #	Description	Quantity Unit	Unit Bid Price	Amount Bid
0095	5800000000-E	1530	ABANDON 6" UTILITY PIPE	1,010 LF	9.25	9,342.50
0096	5801000000-E	1530	ABANDON 8" UTILITY PIPE	1,034 LF	12.25	12,666.50
0097	5816000000-N	1530	ABANDON UTILITY MANHOLE	1 EA	710.00	710.00
0098	5828000000-N	1530	REMOVE UTILITY MANHOLE	2 EA	675.00	1,350.00
0099	5835600000-E	1540	12" ENCASEMENT PIPE	60 LF	100.00	6,000.00
0100	6000000000-E	1605	TEMPORARY SILT FENCE	2,860 LF	2.10	6,006.00
0101	6006000000-E	1610	STONE FOR EROSION CONTROL, CLASS A	285 TON	52.00	14,820.00
0102	6009000000-E	1610	STONE FOR EROSION CONTROL, CLASS B	160 TON	52.00	8,320.00
0103	6012000000-E	1610	SEDIMENT CONTROL STONE	390 TON	45.00	17,550.00
0104	6015000000-E	1615	TEMPORARY MULCHING	4 ACR	1,050.00	4,200.00
0105	6018000000-E	1620	SEED FOR TEMPORARY SEEDING	300 LB	6.30	1,890.00
0106	6021000000-E	1620	FERTILIZER FOR TEMPORARY SEED- ING	2.5 TON	2,100.00	5,250.00
0107	6024000000-E	1622	TEMPORARY SLOPE DRAINS	200 LF	13.50	2,700.00
0108	6029000000-E	SP	SAFETY FENCE	200 LF	2.00	400.00
0109	6030000000-E	1630	SILT EXCAVATION	400 CY	16.00	6,400.00
0110	6036000000-E	1631	MATTING FOR EROSION CONTROL	5,000 SY	1.84	9,200.00
0111	6037000000-E	SP	COIR FIBER MAT	100 SY	4.15	415.00
0112	6038000000-E	SP	PERMANENT SOIL REINFORCEMENT MAT	120 SY	4.15	498.00
0113	6042000000-E	1632	1/4" HARDWARE CLOTH	850 LF	4.10	3,485.00
0114	6070000000-N	1639	SPECIAL STILLING BASINS	6 EA	370.00	2,220.00

Line #	ItemNumber	Sec #	Description	Quantity Unit	Unit Bid Price	Amount Bid
0115	6071010000-E	SP	WATTLE	270 LF	6.20	1,674.00
0116	6071020000-E	SP	POLYACRYLAMIDE (PAM)	90 LB	8.00	720.00
0117	6071030000-E	1640	COIR FIBER BAFFLE	70 LF	7.50	525.00
0118	6071050000-E	SP	*** SKIMMER (1-1/2")	1 EA	1,225.00	1,225.00
0119	6084000000-E	1660	SEEDING & MULCHING	4 ACR	1,835.00	7,340.00
0120	6087000000-E	1660	MOWING	2 ACR	155.00	310.00
0121	6090000000-E	1661	SEED FOR REPAIR SEEDING	50 LB	7.35	367.50
0122	6093000000-E	1661	FERTILIZER FOR REPAIR SEEDING	0.25 TON	2,625.00	656.25
0123	6096000000-E	1662	SEED FOR SUPPLEMENTAL SEEDING	100 LB	5.25	525.00
0124	6108000000-E	1665	FERTILIZER TOPDRESSING	2.5 TON	1,470.00	3,675.00
0125	6111000000-E	SP	IMPERVIOUS DIKE	250 LF	26.00	6,500.00
0126	6114500000-N	1667	SPECIALIZED HAND MOWING	10 MHR	37.00	370.00
0127	6117000000-N	SP	RESPONSE FOR EROSION CONTROL	20 EA	260.00	5,200.00
0128	6120000000-E	SP	CULVERT DIVERSION CHANNEL	280 CY	37.00	10,360.00
0129	6132000000-N	SP	GENERIC EROSION CONTROL ITEM CONCRETE WASHOUT STRUCTURE	6 EA	1,900.00	11,400.00
0130	6890000000-E	SP	CONCRETE STEPS	1 CY	850.00	850.00
0131	7060000000-E	1705	SIGNAL CABLE	920 LF	2.36	2,171.20
0132	7120000000-E	1705	VEHICLE SIGNAL HEAD (12", 3 SECTION)	9 EA	840.00	7,560.00
0133	7132000000-E	1705	VEHICLE SIGNAL HEAD (12", 4 SECTION)	1 EA	1,050.00	1,050.00
0134	7264000000-E	1710	MESSENGER CABLE (3/8")	350 LF	3.15	1,102.50



Line #	ItemNumber	Sec #	Description	Quantity Unit	Unit Bid Price	Amount Bid
0135	7288000000-E	1715	PAVED TRENCHING (*****) (2", 1)	25 LF	31.50	787.50
0136	7300000000-E	1715	UNPAVED TRENCHING (*****) (2", 1)	700 LF	6.30	4,410.00
0137	7324000000-N	1716	JUNCTION BOX (STANDARD SIZE)	8 EA	315.00	2,520.00
0138	7360000000-N	1720	WOOD POLE	2 EA	950.00	1,900.00
0139	7372000000-N	1721	GUY ASSEMBLY	8 EA	370.00	2,960.00
0140	7408000000-E	1722	1" RISER WITH WEATHERHEAD	1 EA	315.00	315.00
0141	7420000000-E	1722	2" RISER WITH WEATHERHEAD	5 EA	475.00	2,375.00
0142	7444000000-E	1725	INDUCTIVE LOOP SAWCUT	700 LF	7.35	5,145.00
0143	7456000000-E	1726	LEAD-IN CABLE (*****) (14-2)	1,675 LF	1.58	2,646.50
0144	7575200000-N	SP	GPS UNIT	2 EA	1,160.00	2,320.00
0145	7636000000-N	1745	SIGN FOR SIGNALS	8 EA	420.00	3,360.00
0146	7684000000-N	1750	SIGNAL CABINET FOUNDATION	1 EA	630.00	630.00
0147	7756000000-N	1751	CONTROLLER WITH CABINET (TYPE 2070L, BASE MOUNTED)	1 EA	11,100.00	11,100.00
0148	7780000000-N	1751	DETECTOR CARD (TYPE 2070L)	5 EA	105.00	525.00
0149	7901000000-N	1753	CABINET BASE EXTENDER	1 EA	420.00	420.00
0150	7948000000-N	1757	TRAFFIC SIGNAL REMOVAL	1 EA	1,900.00	1,900.00
0151	7980000000-N	SP	GENERIC SIGNAL ITEM RELOCATE SCHOOL FLASHER	1 EA	2,100.00	2,100.00

## Contract Item Sheets For C203663

Line #	ItemNumber	Sec #	Description	Quantity Unit	Unit Bid Price	Amount Bid
0152	8042000000-N	402	REMOVAL OF EXISTING STRUCTURES AT STATION ***** (19+67.20 -L-)	Lump Sum LS	55,000.00	55,000.00
0153	8126000000-N	414	CULVERT EXCAVATION, STA ***** (19+67.20 -L-)	Lump Sum LS	35,000.00	35,000.00
0154	8133000000-E	414	FOUNDATION CONDITIONING MATER- IAL, BOX CULVERT	182 TON	53.00	9,646.00
0155	8196000000-E	420	CLASS A CONCRETE (CULVERT)	268.7 CY	555.00	149,128.50
0156	8245000000-E	425	REINFORCING STEEL (CULVERT)	30,621 LB	1.05	32,152.05
0157	8804000000-N	SP	GENERIC CULVERT ITEM PLACEMENT OF NATURAL STREAM BED MATERIAL	Lump Sum LS	9,200.00	9,200.00

**TOTAL AMOUNT OF BID FOR ENTIRE PROJECT**

**\$1,926,671.52**

**EXECUTION OF CONTRACT  
NON-COLLUSION AFFIDAVIT, DEBARMENT CERTIFICATION AND GIFT BAN CERTIFICATION**

**CORPORATION**

The Contractor being duly sworn, solemnly swears (or affirms) that neither he, nor any official, agent or employee has entered into any agreement, participated in any collusion, or otherwise taken any action which is in restraint of free competitive bidding in connection with this Contract, that the Contractor has not been convicted of violating N.C.G.S. § 133-24 within the last three years, and that the Contractor intends to do the work with its own bonafide employees or subcontractors and did not bid for the benefit of another contractor.

By submitting this Execution of Contract, Non-Collusion Affidavit and Debarment Certification, the Contractor is certifying his status under penalty of perjury under the laws of the United States in accordance with the Debarment Certification attached, provided that the Debarment Certification also includes any required statements concerning exceptions that are applicable.

N.C.G.S. § 133-32 and Executive Order 24 prohibit the offer to, or acceptance by, any State Employee of any gift from anyone with a contract with the State, or from any person seeking to do business with the State. By execution of any response in this procurement, you attest, for your entire organization and its employees or agents, that you are not aware that any such gift has been offered, accepted, or promised by any employees of your organization.

**SIGNATURE OF CONTRACTOR**

**Sealand Contractors Corp.**

\_\_\_\_\_  
Full name of Corporation

**1708 North Caldwell Street, Charlotte, NC 28206**

\_\_\_\_\_  
Address as Prequalified

Attest

Valerie Hargreaves  
Secretary/Assistant Secretary  
Select appropriate title

By

Daniel Bree  
President/Vice President/Assistant Vice President  
Select appropriate title

**Valerie Hargreaves**

\_\_\_\_\_  
Print or type Signer's name

**Daniel Bree**

\_\_\_\_\_  
Print or type Signer's name

**CORPORATE SEAL**



**AFFIDAVIT MUST BE NOTARIZED**

Subscribed and sworn to before me this the

5th day of February 2016

Stacy L. Schmitt  
Signature of Notary Public

**NOTARY SEAL**

of Ontario County

State of Ny

My Commission Expires: 1/5/17

**STACY L. SCHMITT**  
Notary Public - State of New York  
No. 01SC6198935  
Qualified in Ontario County  
My Commission Expires January 5, 2017

## DEBARMENT CERTIFICATION

### Conditions for certification:

1. The prequalified bidder shall provide immediate written notice to the Department if at any time the bidder learns that his certification was erroneous when he submitted his debarment certification or explanation filed with the Department, or has become erroneous because of changed circumstances.
2. The terms *covered transaction, debarred, suspended, ineligible, lower tier covered transaction, participant, person, primary covered transaction, principal, proposal, and voluntarily excluded*, as used in this provision, have the meanings set out in the Definitions and Coverage sections of the rules implementing Executive Order 12549. A copy of the Federal Rules requiring this certification and detailing the definitions and coverages may be obtained from the Contract Officer of the Department.
3. The prequalified bidder agrees by submitting this form, that he will not knowingly enter into any lower tier covered transaction with a person who is debarred, suspended, declared ineligible, or voluntarily excluded from participation in NCDOT contracts, unless authorized by the Department.
4. For Federal Aid projects, the prequalified bidder further agrees that by submitting this form he will include the Federal-Aid Provision titled *Required Contract Provisions Federal-Aid Construction Contract (Form FHWA PR 1273)* provided by the Department, without subsequent modification, in all lower tier covered transactions.
5. The prequalified bidder may rely upon a certification of a participant in a lower tier covered transaction that he is not debarred, suspended, ineligible, or voluntarily excluded from the covered transaction, unless he knows that the certification is erroneous. The bidder may decide the method and frequency by which he will determine the eligibility of his subcontractors.
6. Nothing contained in the foregoing shall be construed to require establishment of a system of records in order to render in good faith the certification required by this provision. The knowledge and information of a participant is not required to exceed that which is normally possessed by a prudent person in the ordinary course of business dealings.
7. Except as authorized in paragraph 6 herein, the Department may terminate any contract if the bidder knowingly enters into a lower tier covered transaction with a person who is suspended, debarred, ineligible, or voluntarily excluded from participation in this transaction, in addition to other remedies available by the Federal Government.

### DEBARMENT CERTIFICATION

The prequalified bidder certifies to the best of his knowledge and belief, that he and his principals:

- a. Are not presently debarred, suspended, proposed for debarment, declared ineligible, or voluntarily excluded from covered transactions by any Federal department or agency;
- b. Have not within a three-year period preceding this proposal been convicted of or had a civil judgment rendered against them for commission of fraud or a criminal offense in connection with obtaining, attempting to obtain, or performing a public (Federal, State or local) transaction or contract under a public transaction; violation of Federal or State antitrust statutes or commission of embezzlement, theft, forgery, bribery, falsification or destruction of records; making false statements; or receiving stolen property;
- c. Are not presently indicted for or otherwise criminally or civilly charged by a governmental entity (Federal, State or local) with commission of any of the offenses enumerated in paragraph b. of this certification; and
- d. Have not within a three-year period preceding this proposal had one or more public transactions (Federal, State or local) terminated for cause or default.
- e. Will submit a revised Debarment Certification immediately if his status changes and will show in his bid proposal an explanation for the change in status.

If the prequalified bidder cannot certify that he is not debarred, he shall provide an explanation with this submittal. An explanation will not necessarily result in denial of participation in a contract.

Failure to submit a non-collusion affidavit and debarment certification will result in the prequalified bidder's bid being considered non-responsive.

Check here if an explanation is attached to this certification.

Contract No. C203663

County (ies): Union

ACCEPTED BY THE  
DEPARTMENT OF TRANSPORTATION

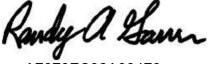
DocuSigned by:  
  
A7079FC32A09478...  
Contract Officer

2/10/2016

Date

Execution of Contract and Bonds  
Approved as to Form:

DocuSigned by:  
  
1889E4C5ADF14AE...  
Attorney General

2/9/2016

Date

Signature Sheet (Bid - Acceptance by Department)

Contract No. C203663  
County Union  
Bond No. 837066427

Rev 5-17-11

### CONTRACT PAYMENT BOND

Date of Payment Bond Execution February 4, 2016  
Name of Principal Contractor Sealand Contractors Corp  
Name of Surety: Liberty Mutual Insurance Company  
Name of Contracting Body: North Carolina Department of Transportation  
Raleigh, North Carolina  
Amount of Bond: One Million Nine Hundred Twenty-Six Thousand Six Hundred  
Seventy-One and 52/100 (\$1,926,671.52)  
Contract ID No.: C203663  
County Name: Union

KNOW ALL MEN BY THESE PRESENTS, That we, the PRINCIPAL CONTRACTOR (hereafter, PRINCIPAL) and SURETY above named, are held and firmly bound unto the above named Contracting Body, hereinafter called the Contracting Body, in the penal sum of the amount stated above for the payment of which sum well and truly to be made, we bind ourselves, our heirs, executors, administrators, and successors, jointly and severally, firmly by these presents.

THE CONDITION OF THIS OBLIGATION IS SUCH, that whereas the principal entered into a certain contract with the Contracting Body, numbered as shown above and hereto attached:

NOW THEREFORE, if the principal shall promptly make payment to all persons supplying labor and material in the prosecution of the work provided for in said contract, and any and all duly authorized modifications of said contract that may hereafter be made, notice of which modifications to the surety being hereby waived, then this obligation to be void; otherwise to remain in full force and virtue.

IN WITNESS WHEREOF, the above-bound parties have executed this instrument under their several seals on the date indicated above, the name and corporate seal of each corporate party being hereto affixed and these presents duly signed by its undersigned representative, pursuant to authority of its governing body.

Contract No. C203663  
County Union

Rev 5-17-11

**CONTRACT PAYMENT BOND**



*Affix Seal of Surety Company*

Liberty Mutual Insurance Company  
Print or type Surety Company Name

By Natalie M. Jimenez  
Print, stamp or type name of Attorney-in-Fact

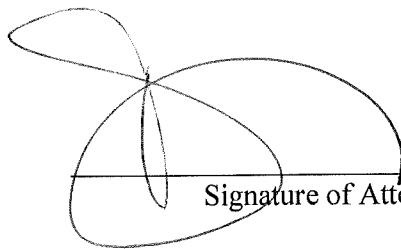
  
Signature of Attorney-in-Fact

  
Signature of Witness

Monique Laroche  
Print or type Signer's name

8 E. Main St., P.O. Box 191, Marcellus, NY 13108  
Address of Attorney-in-Fact



Contract No. C203663  
County Union

Rev 5-17-11

**CONTRACT PAYMENT BOND**

**CORPORATION**

SIGNATURE OF CONTRACTOR (Principal)

Sealand Contractors Corp  
Full name of Corporation

1708 North Caldwell Street, Charlotte, NC 28206  
Address as prequalified

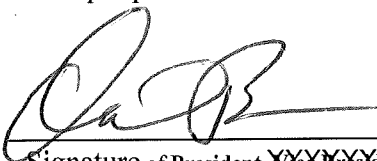
By   
Signature of President, ~~Vice President, Assistant Vice President~~  
Select appropriate title

Daniel Bree  
Print or type Signer's name

*Affix Corporate Seal*

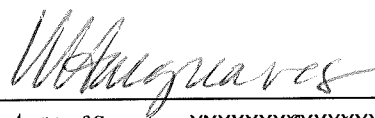

Attest   
Signature of Secretary, ~~Assistant Secretary~~  
Select appropriate title

Valerie Hargreaves  
Print or type Signer's name

**INDIVIDUAL ACKNOWLEDGMENT**

State of \_\_\_\_\_  
County of \_\_\_\_\_

On this \_\_\_\_\_ day of \_\_\_\_\_, \_\_\_\_\_, before me personally appeared \_\_\_\_\_ known to me to be the person \_\_\_\_\_ described in and who executed the foregoing instrument, and \_\_\_\_\_ he \_\_\_\_\_ duly acknowledged to me that \_\_\_\_\_ he \_\_\_\_\_ executed the same.

\_\_\_\_\_  
Notary Public

**CORPORATION ACKNOWLEDGMENT**

State of New York  
County of Ontario

On this 5<sup>th</sup> day of February, 2016, before me personally appeared Daniel Bree to me known, who being by me duly sworn, did depose and say: that he/she resides at Victor, NY; that he/she is President of the corporation described in and which executed the foregoing instrument; that he/she knows the seal of said corporation; that the seal affixed to said instrument is such corporate seal; that it was so affixed by order of the Board of Directors of said corporation; and that he/she signed his/her name thereto by like order.

Stacy L. Schmitt  
Notary Public

**STACY L. SCHMITT**  
Notary Public - State of New York  
No. 01SC6198935  
Qualified in Ontario County  
My Commission Expires January 5, 2017

**SURETY ACKNOWLEDGMENT**

State of New York  
County of Onondaga

On this 4th day of February, 2016, before me personally appeared Natalie M. Jimenez to me known, who being by me duly sworn, did depose and say: that he/she resides in the City of Syracuse, NY; that he/she is the Attorney-In-Fact of the above signed surety, the corporation described in and which executed the within instrument; that he/she knows the corporate seal of said corporation; that the seal affixed to said instrument is such corporate seal; that it was so affixed by order of the Board of Directors of said corporation; and that he/she signed his/her name thereto by like order.

Monique Laroche  
Notary Public

**MONIQUE LAROCHE**  
Notary Public, State of New York  
No. 01LA6319197  
Qualified in Onondaga County  
My Commission Expires Feb. 17, 2019

Contract No. C203663  
County Union  
Bond No. 837066427

Rev 5-17-11

### CONTRACT PERFORMANCE BOND

Date of Performance Bond Execution: February 4, 2016  
Name of Principal Contractor: Sealand Contractors Corp  
Name of Surety: Liberty Mutual Insurance Company  
Name of Contracting Body: North Carolina Department of Transportation  
Raleigh, North Carolina  
Amount of Bond: One Million Nine Hundred Twenty-Six Thousand Six Hundred  
Seventy-One and 52/100 (\$1,926,671.52)  
Contract ID No.: C203663  
County Name: Union

KNOW ALL MEN BY THESE PRESENTS, That we, the PRINCIPAL CONTRACTOR (hereafter, PRINCIPAL) and SURETY above named, are held and firmly bound unto the above named Contracting Body, hereinafter called the Contracting Body, in the penal sum of the amount stated above for the payment of which sum well and truly to be made, we bind ourselves, our heirs, executors, administrators, and successors, jointly and severally, firmly by these presents.

THE CONDITION OF THIS OBLIGATION IS SUCH, that whereas the principal entered into a certain contract with the Contracting Body, numbered as shown above and hereto attached:

NOW THEREFORE, if the principal shall well and truly perform and fulfill all the undertakings, covenants, terms, conditions, and agreements of said contract during the original term of said contract and any extensions thereof that may be granted by the Contracting Body, with or without notice to the Surety, and during the life of any guaranty required under the contract, and shall also well and truly perform and fulfill all the undertakings, covenants, terms, conditions, and agreements of any and all duly authorized modifications of said contract that may hereafter be made, notice of which modifications to the surety being hereby waived, then this obligation to be void; otherwise to remain in full force and virtue.

IN WITNESS WHEREOF, the above-bound parties have executed this instrument under their several seals on the date indicated above, the name and corporate seal of each corporate party being hereto affixed and these presents duly signed by its undersigned representative, pursuant to authority of its governing body.

Contract No. C203663  
County Union

Rev 5-17-11

**CONTRACT PERFORMANCE BOND**

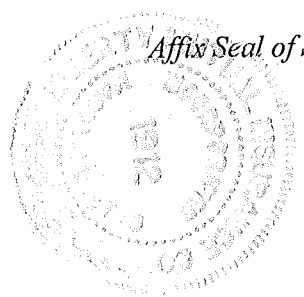

*Affix Seal of Surety Company*

Liberty Mutual Insurance Company  
Print or type Surety Company Name

By Natalie M. Jimenez  
Print, stamp or type name of Attorney-in-Fact

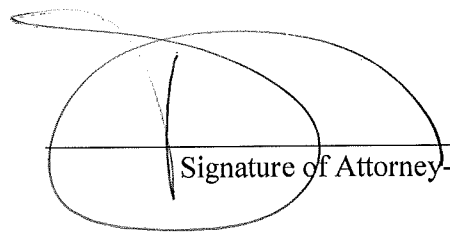
  
Signature of Attorney-in-Fact

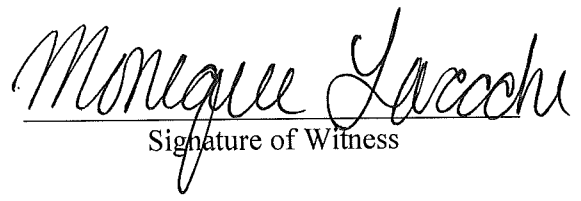
  
Signature of Witness

Monique Laroche  
Print or type Signer's name

8 E. Main St., P.O. Box 191, Marcellus, NY 13108  
Address of Attorney-in-Fact



**INDIVIDUAL ACKNOWLEDGMENT**

State of \_\_\_\_\_  
County of \_\_\_\_\_

On this \_\_\_\_\_ day of \_\_\_\_\_, \_\_\_\_\_, before me personally appeared \_\_\_\_\_ known to me to be the person \_\_\_\_\_ described in and who executed the foregoing instrument, and \_\_\_\_\_ he \_\_\_\_\_ duly acknowledged to me that \_\_\_\_\_ he \_\_\_\_\_ executed the same.

\_\_\_\_\_  
Notary Public

**CORPORATION ACKNOWLEDGMENT**

State of New York  
County of Ontario

On this 5<sup>th</sup> day of February, 2016, before me personally appeared Daniel Bree to me known, who being by me duly sworn, did depose and say: that he/she resides at Victor, NY; that he/she is President of the corporation described in and which executed the foregoing instrument; that he/she knows the seal of said corporation; that the seal affixed to said instrument is such corporate seal; that it was so affixed by order of the Board of Directors of said corporation; and that he/she signed his/her name thereto by like order.

Stacy L. Schmitt  
Notary Public

**STACY L. SCHMITT**  
Notary Public - State of New York  
No. 01SC6198935  
Qualified in Ontario County  
My Commission Expires January 5, 2017

**SURETY ACKNOWLEDGMENT**

State of New York  
County of Onondaga

On this 4<sup>th</sup> day of February, 2016, before me personally appeared Natalie M. Jimenez to me known, who being by me duly sworn, did depose and say: that he/she resides in the City of Syracuse, NY; that he/she is the Attorney-In-Fact of the above signed surety, the corporation described in and which executed the within instrument; that he/she knows the corporate seal of said corporation; that the seal affixed to said instrument is such corporate seal; that it was so affixed by order of the Board of Directors of said corporation; and that he/she signed his/her name thereto by like order.

Monique Laroche  
Notary Public

**MONIQUE LAROCHE**  
Notary Public, State of New York  
No. 01LA6319197  
Qualified in Onondaga County  
My Commission Expires Feb. 17, 2019

**THIS POWER OF ATTORNEY IS NOT VALID UNLESS IT IS PRINTED ON RED BACKGROUND.**

This Power of Attorney limits the acts of those named herein, and they have no authority to bind the Company except in the manner and to the extent herein stated.

Certificate No. 7133199

American Fire and Casualty Company  
The Ohio Casualty Insurance Company

Liberty Mutual Insurance Company  
West American Insurance Company

**POWER OF ATTORNEY**

KNOWN ALL PERSONS BY THESE PRESENTS: That American Fire & Casualty Company and The Ohio Casualty Insurance Company are corporations duly organized under the laws of the State of New Hampshire, that Liberty Mutual Insurance Company is a corporation duly organized under the laws of the State of Massachusetts, and West American Insurance Company is a corporation duly organized under the laws of the State of Indiana (herein collectively called the "Companies"); pursuant to and by authority herein set forth, does hereby name, constitute and appoint, Courtney P. Sprague; Edward J. Reagan; Francis A. Lowther; Monique Laroche; Natalie M. Jimenez; Robert B. Parrish

all of the city of Marcellus, state of NY each individually if there be more than one named, its true and lawful attorney-in-fact to make, execute, seal, acknowledge and deliver, for and on its behalf as surety and as its act and deed, any and all undertakings, bonds, recognizances and other surety obligations, in pursuance of these presents and shall be as binding upon the Companies as if they have been duly signed by the president and attested by the secretary of the Companies in their own proper persons.

IN WITNESS WHEREOF, this Power of Attorney has been subscribed by an authorized officer or official of the Companies and the corporate seals of the Companies have been affixed thereto this 6th day of October, 2015.

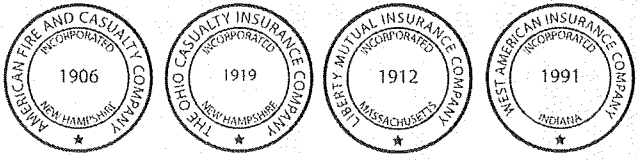

American Fire and Casualty Company  
The Ohio Casualty Insurance Company  
Liberty Mutual Insurance Company  
West American Insurance Company

By: David M. Carey  
David M. Carey, Assistant Secretary

STATE OF PENNSYLVANIA ss  
COUNTY OF MONTGOMERY

On this 6th day of October, 2015, before me personally appeared David M. Carey, who acknowledged himself to be the Assistant Secretary of American Fire and Casualty Company, Liberty Mutual Insurance Company, The Ohio Casualty Insurance Company, and West American Insurance Company, and that he, as such, being authorized so to do, execute the foregoing instrument for the purposes therein contained by signing on behalf of the corporations by himself as a duly authorized officer.

IN WITNESS WHEREOF, I have hereunto subscribed my name and affixed my notarial seal at Plymouth Meeting, Pennsylvania, on the day and year first above written.



COMMONWEALTH OF PENNSYLVANIA  
Notarial Seal  
Teresa Pastella, Notary Public  
Plymouth Twp., Montgomery County  
My Commission Expires March 28, 2017  
Member, Pennsylvania Association of Notaries

By: Teresa Pastella  
Teresa Pastella, Notary Public

This Power of Attorney is made and executed pursuant to and by authority of the following By-laws and Authorizations of American Fire and Casualty Company, The Ohio Casualty Insurance Company, Liberty Mutual Insurance Company, and West American Insurance Company which resolutions are now in full force and effect reading as follows:

**ARTICLE IV – OFFICERS** – Section 12. Power of Attorney. Any officer or other official of the Corporation authorized for that purpose in writing by the Chairman or the President, and subject to such limitation as the Chairman or the President may prescribe, shall appoint such attorneys-in-fact, as may be necessary to act in behalf of the Corporation to make, execute, seal, acknowledge and deliver as surety any and all undertakings, bonds, recognizances and other surety obligations. Such attorneys-in-fact, subject to the limitations set forth in their respective powers of attorney, shall have full power to bind the Corporation by their signature and execution of any such instruments and to attach thereto the seal of the Corporation. When so executed, such instruments shall be as binding as if signed by the President and attested to by the Secretary. Any power or authority granted to any representative or attorney-in-fact under the provisions of this article may be revoked at any time by the Board, the Chairman, the President or by the officer or officers granting such power or authority.

**ARTICLE XIII – Execution of Contracts – SECTION 5. Surety Bonds and Undertakings.** Any officer of the Company authorized for that purpose in writing by the chairman or the president, and subject to such limitations as the chairman or the president may prescribe, shall appoint such attorneys-in-fact, as may be necessary to act in behalf of the Company to make, execute, seal, acknowledge and deliver as surety any and all undertakings, bonds, recognizances and other surety obligations. Such attorneys-in-fact subject to the limitations set forth in their respective powers of attorney, shall have full power to bind the Company by their signature and execution of any such instruments and to attach thereto the seal of the Company. When so executed such instruments shall be as binding as if signed by the president and attested by the secretary.

**Certificate of Designation** – The President of the Company, acting pursuant to the Bylaws of the Company, authorizes David M. Carey, Assistant Secretary to appoint such attorneys-in-fact as may be necessary to act on behalf of the Company to make, execute, seal, acknowledge and deliver as surety any and all undertakings, bonds, recognizances and other surety obligations.

**Authorization** – By unanimous consent of the Company's Board of Directors, the Company consents that facsimile or mechanically reproduced signature of any assistant secretary of the Company, wherever appearing upon a certified copy of any power of attorney issued by the Company in connection with surety bonds, shall be valid and binding upon the Company with the same force and effect as though manually affixed.

I, Gregory W. Davenport, the undersigned, Assistant Secretary, of American Fire and Casualty Company, The Ohio Casualty Insurance Company, Liberty Mutual Insurance Company, and West American Insurance Company do hereby certify that the original power of attorney of which the foregoing is a full, true and correct copy of the Power of Attorney executed by said Companies, is in full force and effect and has not been revoked.

IN TESTIMONY WHEREOF, I have hereunto set my hand and affixed the seals of said Companies this 4th day of February, 2016.



By: Gregory W. Davenport  
Gregory W. Davenport, Assistant Secretary

Not valid for mortgage, note, loan, letter of credit, currency rate, interest rate or residual value guarantees.

To confirm the validity of this Power of Attorney call 1-610-832-8240 between 9:00 am and 4:30 pm EST on any business day.



LIBERTY MUTUAL INSURANCE COMPANY  
FINANCIAL STATEMENT — DECEMBER 31, 2014

<b>Assets</b>		<b>Liabilities</b>	
Cash and Bank Deposits.....	\$744,221,142	Unearned Premiums.....	\$6,288,178,795
*Bonds — U.S Government.....	1,718,117,704	Reserve for Claims and Claims Expense .....	16,879,324,618
*Other Bonds.....	11,205,872,087	Funds Held Under Reinsurance Treaties.....	211,983,009
*Stocks .....	9,533,437,819	Reserve for Dividends to Policyholders.....	1,246,547
Real Estate.....	277,742,849	Additional Statutory Reserve.....	40,877,587
Agents' Balances or Uncollected Premiums.....	4,150,041,316	Reserve for Commissions, Taxes and	
Accrued Interest and Rents.....	129,261,358	Other Liabilities .....	2,664,248,124
Other Admitted Assets.....	<u>14,896,464,393</u>	<b>Total .....</b>	<b>\$26,085,858,680</b>
<b>Total Admitted Assets.....</b>	<b><u>\$42,655,158,668</u></b>	Special Surplus Funds.....	\$53,954,363
		Capital Stock.....	10,000,000
		Paid in Surplus.....	8,829,117,542
		Unassigned Surplus.....	7,676,228,083
		<b>Surplus to Policyholders .....</b>	<b><u>16,569,299,988</u></b>
		<b>Total Liabilities and Surplus .....</b>	<b><u>\$42,655,158,668</u></b>



\* Bonds are stated at amortized or investment value; Stocks at Association Market Values.  
The foregoing financial information is taken from Liberty Mutual Insurance Company's financial statement filed with the state of Massachusetts Department of Insurance.

I, TIM MIKOLAJEWSKI, Assistant Secretary of Liberty Mutual Insurance Company, do hereby certify that the foregoing is a true, and correct statement of the Assets and Liabilities of said Corporation, as of December 31, 2014, to the best of my knowledge and belief.

IN WITNESS WHEREOF, I have hereunto set my hand and affixed the seal of said Corporation at Seattle, Washington, this 20th day of March, 2015.

*T. Mikolajewski*

\_\_\_\_\_  
Assistant Secretary